



Influence of Rare Earth Sm Addition on Microstructure and Tensile Properties of Al-Si-Cu 319 Alloy

D.N. Patel, M.P. Sutaria * 

Department of Mechanical Engineering, Chandubhai S. Patel Institute of Technology,
Charotar University of Science and Technology (CHARUSAT), Changa, Anand-388421, Gujarat, India

* Corresponding author: Email address: mayursutaria.me@charusat.ac.in

Received 02.08.2022; accepted in revised form 02.10.2022; available online 03.02.2023

Abstract

In the present investigation, the influence of addition of the rare earth element samarium (Sm) in different concentrations (0, 0.1, 0.3, 0.5, 0.7 and 0.9wt.%) on the microstructure and tensile properties of the Al-Si-Cu 319 alloy have been evaluated. Microstructural constituents such as SDAS of α -Al and characteristics of eutectic silicon particles were observed by optical microscopy. It was concluded from the findings that Sm addition reduces the size of secondary dendrite arm spacings (SDAS) and altered the morphology of the eutectic silicon particles from needle-like to lamellar and smaller segments. The tensile properties of the Al-Si-Cu 319 alloy improved with the concentration of Sm. It was found that the highest tensile properties were obtained at 0.7wt.% addition of Sm, i.e., 55.5% higher than unmodified 319 alloy. With the further addition of the Sm above 0.7wt.%, it does not improve the tensile properties of the alloy. This can be attributed to the precipitation of the brittle and needle like quaternary Sm-rich intermetallic compounds observed through Scanning electron microscopy.

Keywords: Al-Si-Cu 319 alloy, Samarium, SDAS, Eutectic silicon, Tensile properties

1. Introduction

Al-Si-Cu casting alloys have found use in a variety of automotive applications, including engine blocks, pistons, cylinder heads etc. because of their outstanding mechanical properties, excellent castability and corrosion resistance. The hypoeutectic Al-Si-Cu 319 alloy is one of the most widely used casting alloy in automotive, aerospace and defence industries from Al-Si-Cu family [1-5]. It is well known that microstructural features such as grain size of α -Al, morphology of eutectic Silicon and SDAS significantly influence the mechanical behaviour of Al-Si hypoeutectic casting alloy. Commercial hypoeutectic Al-Si casting alloys have a microstructure that resembles flake-like eutectic silicon phases and coarse primary-Al dendrites under normal cooling conditions. The flake like eutectic silicon phases are brittle

in nature and act as stress concentrators reducing the mechanical properties of alloy [6]. Therefore, it becomes necessary to refine the morphological structure of eutectic silicon in order to achieve good mechanical properties. Traditionally, chemical modification is carried out by the addition of Ca, Na, Sr, etc. to alter the morphology from flake like structure of eutectic silicon to fine fibrous one [7].

In the last two decades, rare earth (RE) elements such as La, Ce, Sc, Er, Gd, Eu, etc. have been explored as potential eutectic silicon modifiers in Al-Si alloys [8-12]. They have received significant attention due to certain advantages over the traditional modifiers such as lower diffusivity and lower gas pickup tendency. Additionally, because of their lower solid solubility in aluminium and higher melting point, they can form intermetallic compounds which are stable and acts as a strengthening phase resulting in improved mechanical properties of alloys [13-14].



Previously, many studies have been conducted to observe the influence of rare earth element Sm on the morphological structure of eutectic silicon, the size of the aluminium as well as on the mechanical behaviour of Al-Si alloys [15-19]. Zhi et al. studied the effect of Sm in different content (0-2.5wt.%) on the microstructural characteristics and mechanical behaviour of Al-Si-Cu alloy. It was reported that the addition of the Sm refines coarse grains of α -Al and it also changed the shape of the harmful iron-rich phase from Chinese script like to a slender phase. The highest tensile properties were achieved at 1wt.% Sm concentration [15]. Qui et al. analyzed the morphology of α -Al grains and eutectic silicon of Sm added near eutectic Al-12Si alloy. They observed that the addition of Sm in Al-12Si alloy depresses the eutectic temperature. The ultimate tensile strength (217MPa) and elongation (1.3%) were obtained at the 0.6wt.% Sm addition [16]. Qui et al. developed A356 alloys modified with different content (0.3, 0.6 and 0.9wt.%) of the Sm. They found that samarium had a good effect on the eutectic silicon. The excellent combination of the elongation (3.3%) and ultimate tensile strength (215MPa) was obtained at 0.6wt.% of Sm due to complete modification of the eutectic silicon phase with fibrous structure [17]. Rao et al. observed the morphologies of eutectic silicon and iron rich β -Al₅FeSi phase in 0, 0.5, 1 and 1.5wt.% Sm containing A384 (ADC 12) alloys. They found that 1wt.% addition of Sm decreases the size of the harmful β -Al₅FeSi phase. Acicular eutectic silicon phases converted into small particles when Sm addition was 1-1.5wt.% [18]. Li et al. studied the influence of different concentrations (0.2, 0.4, 0.6 and 0.8) of Sm in Al-20%Si alloy. They noticed the morphology of the primary silicon altered from the coarse polygonal like shape to a fine blocky shape with smooth corners and edges when the Sm addition increased from 0.2 to 0.6wt.%. Eutectic silicon particles were completely modified into fine particles with the addition of 0.6wt.% Sm. Because of the modified primary and eutectic silicon phases, UTS and elongation increased by 48.5% and 68.8%, respectively as compared to base alloy [19].

It is also well known that rare earth elements are classified into light and heavy rare earth elements. Most of the previous research work has been carried out on the influence of the light rare earth elements in Al-Si casting alloys such as Ce and La. The addition of the 0.5wt.% Ce in A380 alloy effectively reduces the size of eutectic silicon and the size of β -Al₅FeSi intermetallic phases. The addition of La in A356 alloy decreases eutectic growth temperature and eutectic nucleation. The combined addition of the Ce and La significantly reduces (60%) the grain size as compared to the base alloy and reduces the nucleation temperature of the α -Al [20-21].

Meanwhile, as per the earlier reported study, the positive influence of other light rare earth element Sm has been observed in Al-Si-Mg A356 alloy and Al-Si-Cu A384 alloy. An Al-Si-Cu 319 alloy is very popular in the manufacturing of the automobile components. There is a possibility to further increase in mechanical properties by addition of rare earth element Sm also there is a need to evaluate the effect of other light rare earth elements in hypoeutectic Al-Si-Cu 319 alloy. Therefore, the main goal of this study is to assess the influence of Sm on the microstructure and tensile properties of Al-Si-Cu 319 alloy.

2. Materials and Methods

In the current study, hypoeutectic Al-Si-Cu 319 alloy was selected as base alloy. Chemical compositions of the 319 alloy and with various concentrations of Sm were analyzed by inductively coupled plasma optical emission spectroscopy (ICP-OES) and are presented in Table 1.

Various alloys with different concentrations (0.1, 0.3, 0.5, 0.7, and 0.9wt.%) of Sm were developed by using an appropriate amount of Al-20wt.%Sm master alloy. Initially, ingots of 319 alloys were melted in the electrical resistance furnace.

Table 1.

Chemical composition of the developed 319 alloys (wt.%)

Alloy designation	Si	Cu	Fe	Sm	Al
Unmodified 319 alloy	5.98	3.75	0.75	-	Bal.
319 alloy+0.1% Sm	5.84	3.64	0.72	0.09	Bal.
319 alloy+0.3% Sm	5.72	3.57	0.56	0.26	Bal.
319 alloy+0.5% Sm	5.77	3.46	0.64	0.44	Bal.
319 alloy+0.7% Sm	5.83	3.53	0.56	0.68	Bal.
319 alloy+0.9%Sm	5.67	3.56	0.68	0.81	Bal.

After melting the alloy, Sm was introduced into melt using Al-20wt.%Sm master alloy which was wrapped in aluminium foil. In order to obtain complete dissolution of the Sm, melt was held isothermally at 750°C for 30 minutes. Subsequently, the melt was degassed by purging pure argon gas for three minutes while maintaining a gas flow rate of 2L/min. Metal mold was preheated in electric resistance furnace after being coated with graphite suspension. The furnace temperature was kept at 450°C while preheating the metal mold. Afterwards, a pouring was done at 720°C into the cast iron mold as indicated in figure 1.

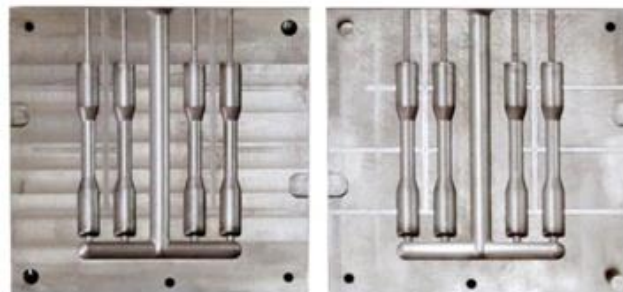

Fig 1. Cast iron metal mold

Later samples were prepared for mechanical testing and metallographic observation. A total of 6 pourings were carried out corresponding to the unmodified 319 alloy and alloys having different wt.% (0.1, 0.3, 0.5, 0.7 and 0.9) of Sm.

2.1. Microstructural examination and phase identification

In order to observe microstructure of the developed modified alloys, samples were prepared according to ASTM E3 standard.

The samples were then etched by 0.5 vol% HF acid with slight nital wipe. After preparation of samples, optical microscopy (OM) was used to observe the morphology of the cast alloys using a Carl Zeiss inverted metallurgical microscope. Quantitative metallography was performed by the ImageJ image analysis software. The measurement of SDAS and eutectic Si characteristics such as mean area, aspect ratio and length were carried out. An average value of 30 measurements was reported. In order to determine the intermetallic compounds and their elemental composition, scanning electron microscopy (SEM) and EDS point analysis were performed using JSM 7600F. The presence of phases in unmodified and modified alloys was detected by x-ray diffraction (XRD, D2 phaser, BRUKER) scanning from 20° to 80° with copper $K\alpha$ radiation.

2.2. Mechanical Characterization

Cylindrical tensile testing specimens were prepared according to ASTM E8 standard for analysis of tensile properties as shown in figure 2. The tests were conducted using a universal testing machine to measure ultimate tensile strength (UTS) and elongation (EL). Tensile testing was performed at a rate of 5mm/min for the best three specimens chosen for each alloy.

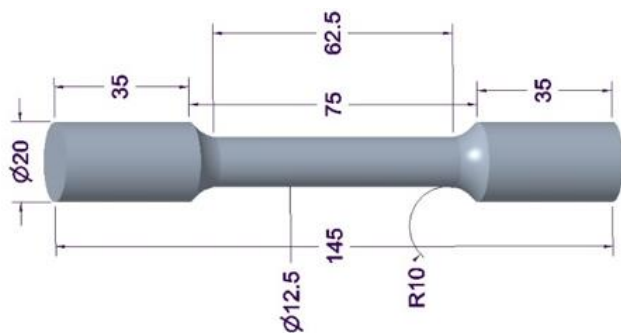

Fig. 2. Dimensions of the cylindrical tensile test specimen (Unit: mm)

3. Results and Discussion

3.1. Effect of Sm on SDAS of primary α -Al

Microstructure of the different Sm containing alloys evaluated in terms of SDAS and size of eutectic silicon characteristics. It is well established that the presence of inoculants/solute atoms in the melt is the main cause of refinement of α -Al dendrites in aluminium casting alloys [22]. The presence of several particles such as $TiAl_3$, AlB_2 and TiB_2 in the melt can serve as heterogeneous nucleation sites for the refinement of primary α -Al grains [23-25]. Figure 3. presents the SDAS of the cast alloys with different content of the Sm. It is observed from figure 3. that the size of SDAS is decreasing as the content of Sm increases up to 0.7wt.%.

The SDAS of the unmodified Al-Si-Cu 319 alloy is $42.04 \mu m$. The SDAS value of 0.1, 0.3 and 0.5 wt.% Sm containing alloys is 33.68,

25.32 and $22.7 \mu m$, respectively. In the present study, 0.7wt.% Sm modified alloy has the lowest SDAS. The value of SDAS of 0.7wt.% Sm containing alloy is $20.26 \mu m$. The reduction in SDAS of Sm modified alloys may be attributed to the enrichment of the Sm at the solid/liquid interface due to lower diffusion coefficient and limited solid solubility of the Sm in aluminium. The aggregation of Sm ahead of solid/liquid interface forms high melting point intermetallic particles restricting the growth of α -Al. Additionally, the formation of the Sm containing intermetallic phases having a higher melting point at the solid/liquid interface also retard the growth of α -Al grains [26].

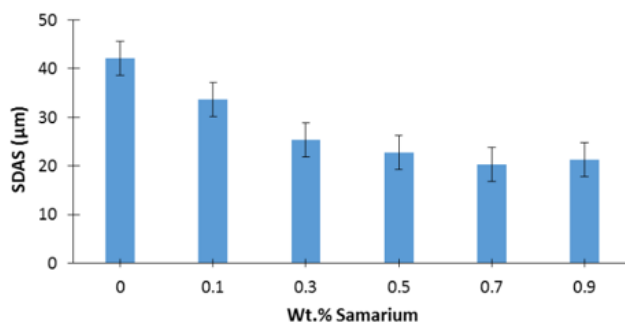

Fig. 3. SDAS of alloys with various concentrations of Sm

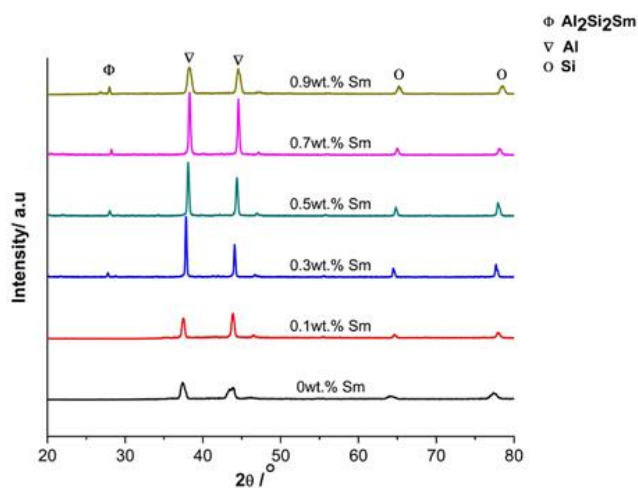

Fig 4. XRD spectra of unmodified and Sm modified alloys

XRD analysis of the Al-Si-Cu 319 alloy and various Sm containing alloys is shown in figure 4. It presents the presence of the α -Al, Si along with Al_2Si_2Sm intermetallic phase in 0.3 to 0.9wt.% Sm containing alloys. The formation of the Al_2Si_2Sm intermetallic compound in the interdendritic region restricted grain growth [27]. On the other hand, increasing the content of Sm above 0.7wt% it does not further refine SDAS. The value of 0.9wt.% Sm modified alloy is $21.18 \mu m$, the addition of the Sm at higher wt.% precipitates larger intermetallic compounds which cannot serve as heterogeneous nucleation sites for retarding the growth of α -Al.

3.2. Effect of Sm on eutectic silicon

There are mainly two theories which explain the alteration of the eutectic silicon phase in Al-Si casting alloy named as: “twine plane re-entrant edge” (TPRE) and “impurity induced twinning” (IIT). From these two mechanisms, IIT mechanism is widely accepted. Eutectic silicon characteristics of the unmodified and Sm modified Al-Si-Cu 319 alloys are presented in figure 5. Figure 6. shows the optical micrographs captured at 500X. It presents the morphology of the eutectic silicon phase of 319 alloys with different concentrations of the Sm.

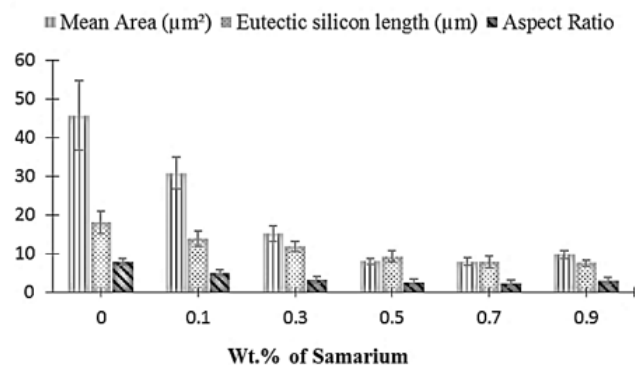

Fig 5. Characteristics of eutectic silicon of various Sm concentrated alloys

The mean area and aspect ratio of eutectic silicon decrease up to 0.7wt.% Sm addition and slightly increase above 0.7wt.% Sm addition. As shown in figure 6(a), the microstructure of the unmodified Al-Si-Cu 319 alloy consists of flake like eutectic silicon phases along with the primary α -Al grains. In the unmodified alloy, the length of eutectic Si is 18.03 μm . The length of the eutectic silicon particle decreases when the content of Sm increases refer to figure 5. It has been observed from figure 6(b-d) that the morphology of the eutectic silicon phase changed from needle like to lamellar structure up to 0.5wt.% addition of Sm. Above 0.5wt.% addition of Sm, eutectic silicon phases altered from lamellar to smaller fragments. When the Sm concentration is increased from 0.1 to 0.5 wt.%, the eutectic silicon length reduces from 13.82 to 9.20 μm .

As per the IIT mechanism, the atoms of modifier/impurity adsorbed at the growth stage of the eutectic silicon during the solidification resulting in the formation of multiple twins. These twin defects retard the fast growth of silicon and provide multiple growth directions and causing the transformation of long flake like silicon into smaller globular particles. The ideal radius ratio i.e., the ratio of the modifier element's atomic radius to that of silicon

should be 1.646 to encourage impurity induced twinning [28]. The rare earth Sm has atomic radius ratio of 1.53 very near to the optimal value and therefore, Sm is predicted as a good modifier for modification of the eutectic silicon phase.

Based on the Hume-Rothery rule [29] of solid solution, limited solid solution can form in the alloy system when the difference of atomic radius of solute and solvent is more than 15%. The atomic radius difference between Al and Sm is 29%, therefore, solid solubility of Sm in aluminium is very less. In the current study, changes in the morphology of the eutectic silicon phases can be attributed to the accumulation of the Sm at the solid/liquid interface during solidification. This aggregation of Sm will retard the growth of silicon and thus, refinement of the eutectic silicon phases occurred. It is also revealed from fig 6(e, f) that further addition of the Sm from 0.7 to 0.9wt.% has not altered the morphology of eutectic silicon.

3.3. Tensile properties of modified alloys

It is well known that the microstructural constituents (size and shape of α -Al grains and characteristics of eutectic Si) have a significant influence on the mechanical performance of Al-Si casting alloys. Figure 7. indicates the ultimate tensile strength (UTS) and elongation of Sm modified alloys. It can be observed from the figure that the unmodified 319 alloy has UTS of 135 MPa and elongation of 1.9%. It is also revealed that the addition of the Sm from 0.1 to 0.5wt.% enhanced the UTS from 152 to 182 MPa. of the alloy i.e., 12.59 and 34.81% higher than unmodified alloy and elongation increases from 2.1 to 3.1%. The highest UTS (210MPa) and elongation (3.7%) were obtained at addition of 0.7wt.% Sm.

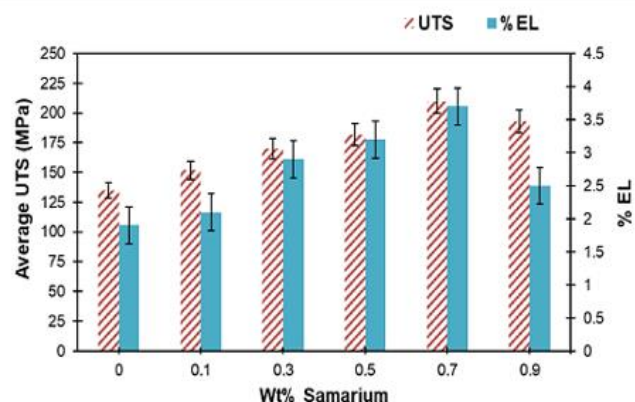

Fig 7. UTS and elongation of Sm modified alloys

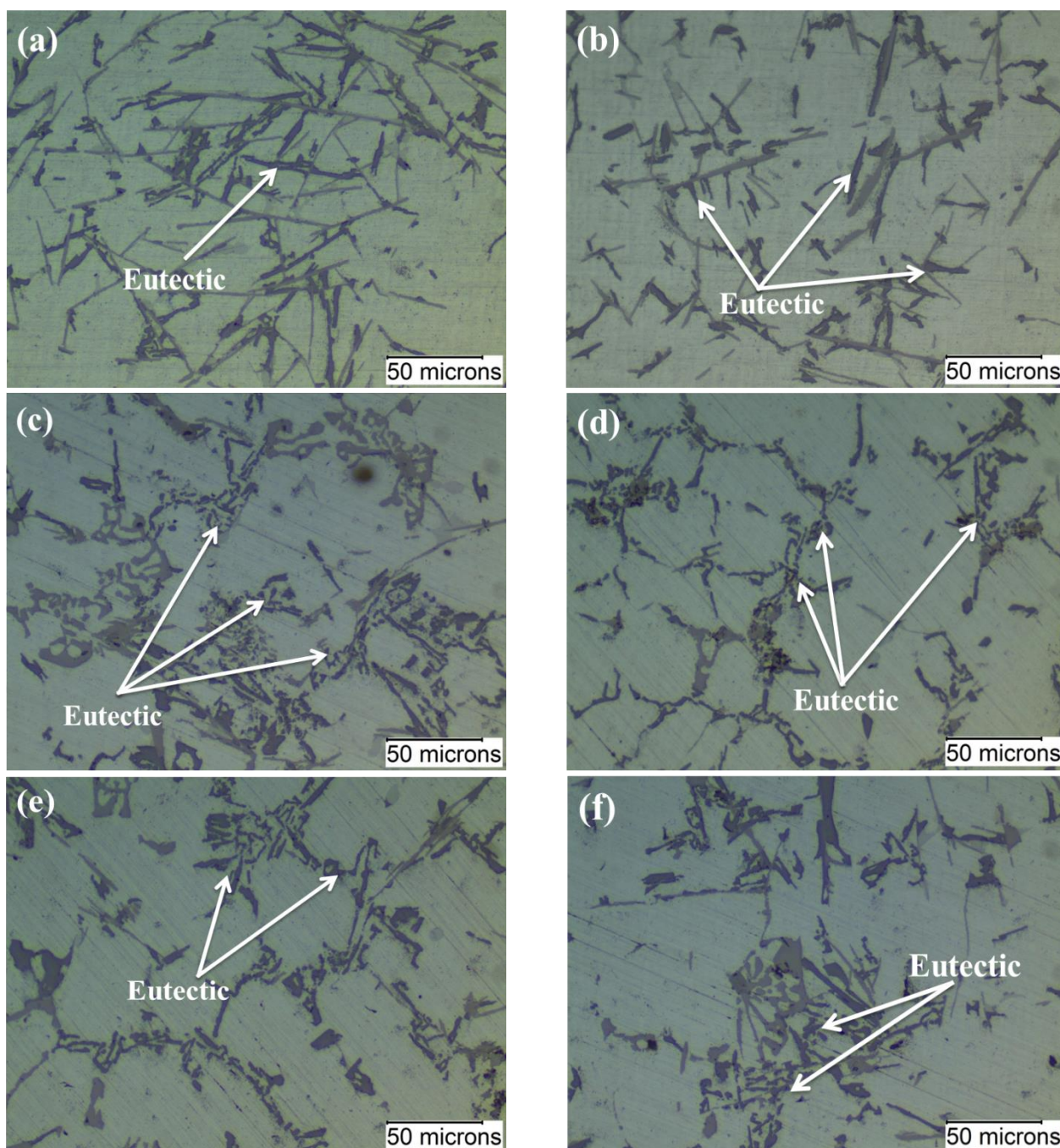

Fig 6. Optical micrographs presenting morphologies of eutectic silicon (a) 0wt.%Sm (b) 0.1wt.%Sm (c) 0.3wt.%Sm (d) 0.5wt.%Sm (e) 0.7wt.%Sm (f) 0.9wt.%Sm

The addition of the Sm has a great effect on the tensile properties of the 319 alloy. Sm modified alloys possess the highest tensile strength due to refinement of SDAS and eutectic Si phases. Apart from the refined aluminium grains and eutectic silicon phase, smaller size of the iron-rich phases has also a good impact on the mechanical properties of the Al-Si alloy. Refined grains retard the movement of dislocations which also improves the mechanical

properties of alloy. On the other hand, UTS and elongation of the 0.9wt.% Sm modified alloy is slightly decreased.

As indicated in Figure 8 (a,b) that Sm-rich intermetallic phases possess needle like structures in 0.9wt% Sm modified alloy. EDS point analysis of the location marked in SEM images reveals the presence of Al-Si-Cu-Sm quaternary intermetallic compounds. Reduction in tensile properties of 0.9wt.% Sm modified alloy can

be attributed to precipitation of the Sm rich intermetallic compounds having brittle nature and needle like morphology.

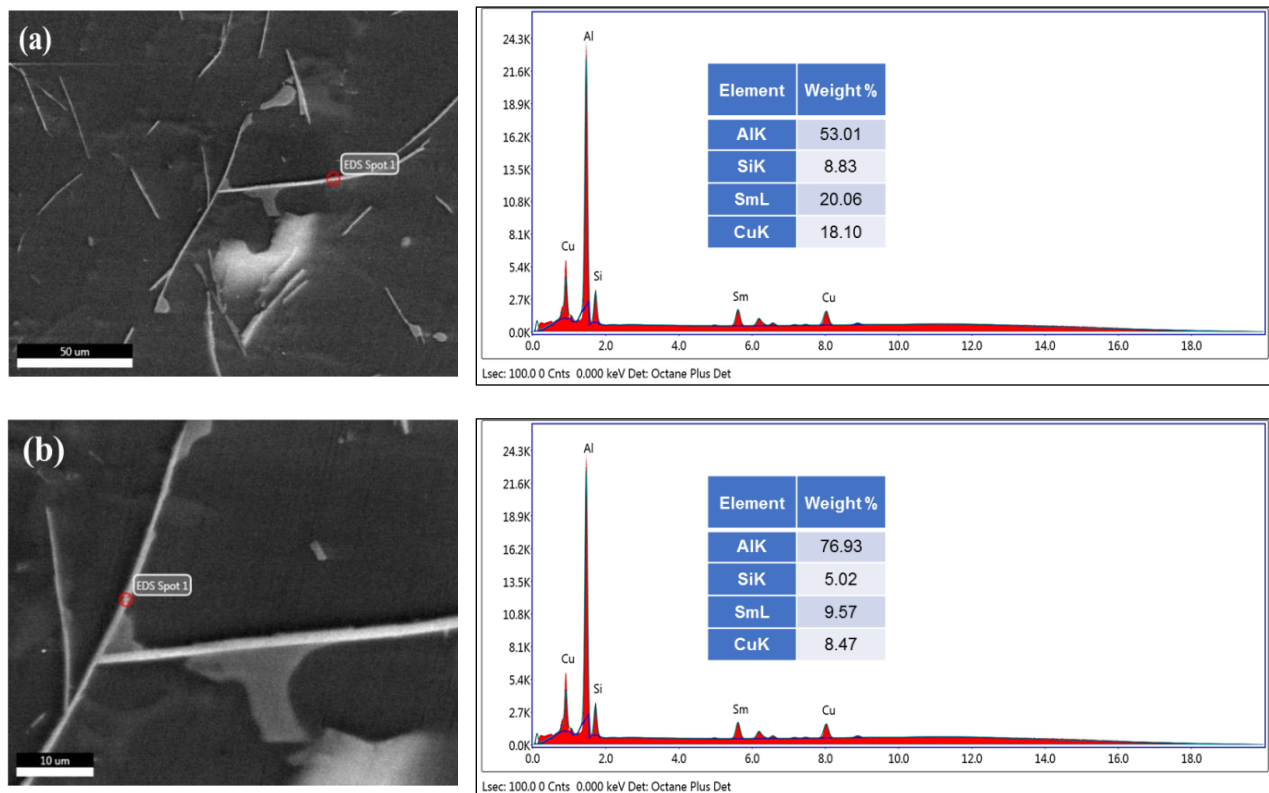

Fig. 8(a,b). SEM images with EDS analysis of Sm rich intermetallic compound in 319 alloy with 0.9wt.% Sm Concentration

3.4 Analysis of fractured surface

Figure 9. illustrates the fractured morphology of the unmodified alloy and different Sm modified alloys. It has been clearly observed from the figure 9 (a-c) that the fractured surface of the unmodified alloy and alloy having lower concentrations (0.1 and 0.3wt.%) of Sm is mainly covered by the irregular cleavage plane. It indicates the brittle type of fracture leading to

lower strength of the alloy. Figure 9 (d, e) shows that as the addition of the Sm increases from 0.5 to 0.7wt.%, fractured surface of the alloy covered by the dimples along with cleavage planes indicating the mixed mode of ductile and brittle failure. Fractured surface of the 0.9wt.% Sm modified alloys as shown in figure 9 (f) is covered with the more numbers dimples indicating ductile type of fracture.

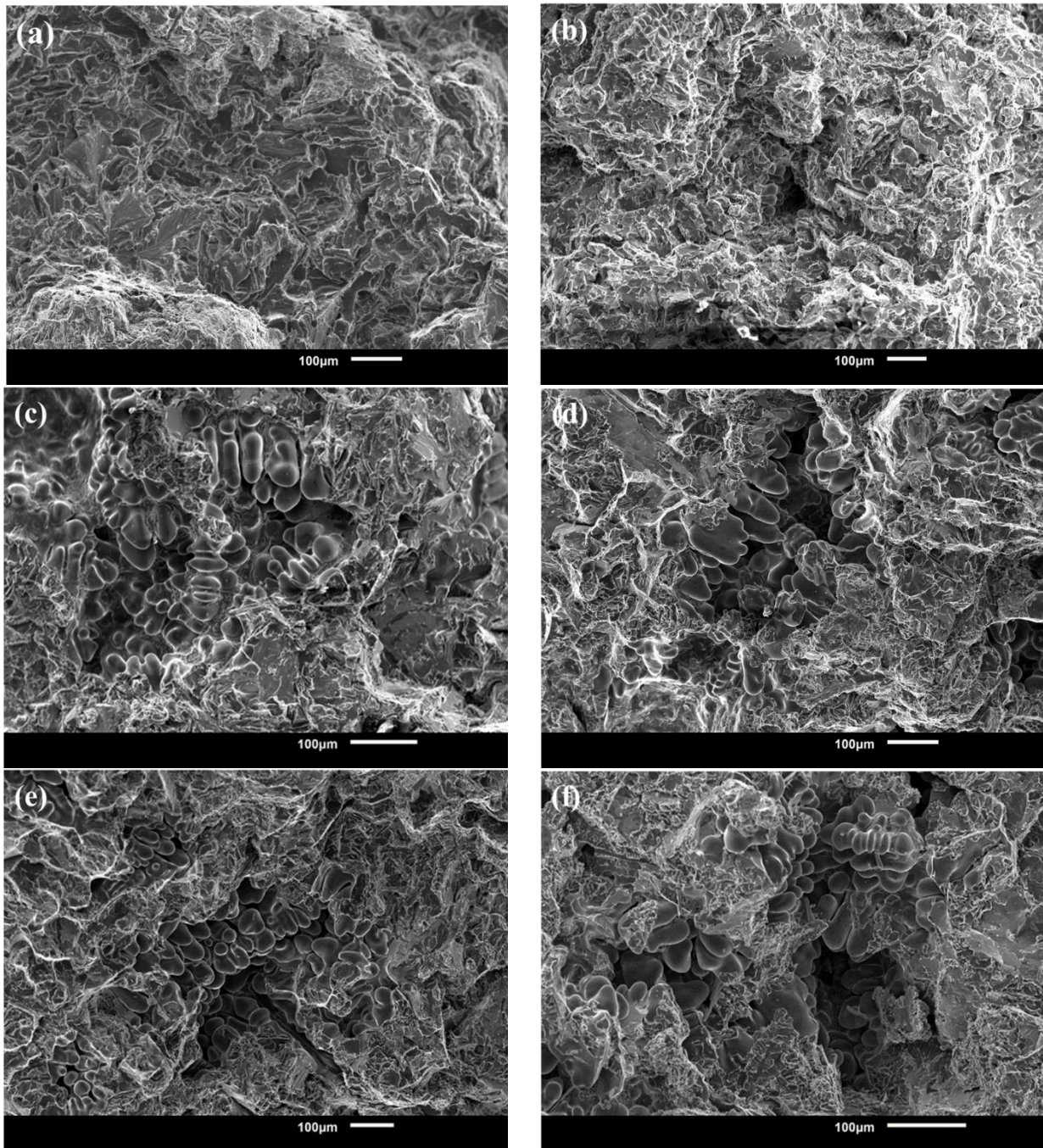

Fig 9. Fractured surfaces with various contents of Sm (a) 0 wt% Sm (b) 0.1 wt% Sm (c) 0.3 wt% Sm (d) 0.5 wt% Sm (e) 0.7 wt% Sm (f) 0.9 wt% Sm

4. Conclusions

The influence of rare earth element Sm on microstructural features and tensile properties of hypoeutectic Al-Si-Cu 319 alloy

was evaluated. The following findings have been derived from this study.

- Addition of the Sm refines SDAS of primary α -Al grains as well as modifies the morphology of eutectic silicon phase from flake like to smaller particles.

- The SDAS decreased up to 51.8% with addition of Sm up to 0.7wt.% in the Al-Si-Cu 319 alloy. The addition of 0.9wt.% Sm does not further refine SDAS of primary α -Al grains.
- Eutectic Silicon length decreased by 48.9% with the addition of 0.5wt.% Sm in the Al-Si-Cu 319 alloy.
- Tensile properties of Sm modified alloys enhanced up to 0.7wt.% due to refinement of primary α -Al grains and eutectic silicon phases. The highest tensile strength was obtained at the 0.7wt.% Sm addition i.e., 55.5% higher than unmodified alloy. Above 0.7wt.% Sm, both UTS and elongation decrease. It can be attributed to the precipitation of the Sm-rich quaternary brittle intermetallic phases.

Acknowledgements

The authors greatly acknowledge the support from the Department of Science and Technology (DST), New Delhi, which sponsored SMART Foundry Project (DST/TSG/AMT/2015/332 dated 17/08/2016). This work was carried out at materials processing laboratory with support from the Charotar University of Science and Technology (CHARUSAT), Changa.

References

- [1] ASM Handbook Committee. (1990). *Properties and selection: nonferrous alloys and special-purpose materials* (pp. 597-599). ASM International.
- [2] Hernandez, F.C.R., Ramirez, J.M.H., Mackay, R. (2017). *Al-Si alloys: automotive, aeronautical, and aerospace applications*. Springer International Publishing. Retrieved 30 April 2022 from Springer link <http://link.springer.com/10.1007/978-3-319-58380-8>.
- [3] Alkahtani, S. (2012). Mechanical performance of heat treated 319 alloys as a function of alloying and aging parameters. *Materials & Design*. 41, 358-369. <https://doi.org/10.1016/j.matdes.2012.04.034>.
- [4] Javidani, M. & Larouche, D. (2014). Application of cast Al-Si alloys in internal combustion engine components. *International Materials Reviews*. 59(3), 132-158. <https://doi.org/10.1179/1743280413Y.0000000027>.
- [5] Lombardi, A., Ravindran, C. & MacKay, R. (2015). Optimization of the solution heat treatment process to improve mechanical properties of 319 Al alloy engine blocks using the billet casting method. *Materials Science and Engineering: A*, 633, 125-135. <https://doi.org/10.1016/j.msea.2015.02.076>.
- [6] Hegde, S. & Prabhu, K.N. (2008). Modification of eutectic silicon in Al-Si alloys. *Journal of materials science*. 43(9), 3009-3027. <https://doi.org/10.1007/s10853-008-2505-5>.
- [7] Sigworth, G.K. (2008). The modification of Al-Si casting alloys: important practical and theoretical aspects. *International Journal of Metalcasting*. 2(2), 19-40. <https://doi.org/10.1007/BF03355425>.
- [8] Mahmoud, M.G., Zedan, Y., Samuel, A.M., Doty, H.W., Songmene, V. & Samuel, F.H. (2021). Effect of rare earth metals (Ce and La) addition on the performance of Al-Si-Cu-Mg Cast Alloys. *International Journal of Metalcasting*. 1-27. <https://doi.org/10.1007/s40962-021-00669-6>.
- [9] Mahmoud, M.G., Zedan, Y., Samuel, A.M., Songmene, V. & Samuel, F.H. (2022). The use of rare earth metals in Al-Si-Cu casting alloys. *International Journal of Metalcasting*. 16(2), 535-552. <https://doi.org/10.1007/s40962-021-00640-5>.
- [10] Patel, D.N. & Sutaria, M.P. (2022). Effect of Trace Rare Earth Er Addition on Microstructure and Tensile Properties of 319 Al-Si-Cu Alloy. *International Journal of Metalcasting*. 16, 2199-2209. <https://doi.org/10.1007/s40962-021-00730-4>.
- [11] Xu, C., Xiao, W., Hanada, S., Yamagata, H. & Ma, C. (2015). The effect of scandium addition on microstructure and mechanical properties of Al-Si-Mg alloy: A multi-refinement modifier. *Materials Characterization*. 110, 160-169. <https://doi.org/10.1016/j.matchar.2015.10.030>.
- [12] Mao, F., Yan, G., Xuan, Z., Cao, Z. & Wang, T. (2015). Effect of Eu addition on the microstructures and mechanical properties of A356 aluminum alloys. *Journal of Alloys and Compounds*. 650, 896-906. <https://doi.org/10.1016/j.jallcom.2015.06.266>.
- [13] Nie, Z.R., Jin, T., Fu, J., Xu, G., Yang, J., Zhou, J.X. & Zuo, T.Y. (2002). Research on rare earth in aluminum. *Materials Science Forum*. 396-402, 1731-1740. <https://doi.org/10.4028/www.scientific.net/MSF.396-402.1731>.
- [14] Nie, Z. R., Fu, J.B., Zou, J.X., Jin, T.N., Yang, J.J., Xu, G. F., Ruan, H. Q. & Zuo, T.Y. (2004). Advanced aluminum alloys containing rare-earth erbium. *Materials forum*. 28, 197-201.
- [15] Hu, Z., Yan, H. & Rao, Y.S. (2013). Effects of samarium addition on microstructure and mechanical properties of as-cast Al-Si-Cu alloy. *Transactions of Nonferrous Metals Society of China*. 23(11), 3228-3234. [https://doi.org/10.1016/S1003-6326\(13\)62857-5](https://doi.org/10.1016/S1003-6326(13)62857-5).
- [16] Qiu, H., Yan, H. & Hu, Z. (2014). Modification of near-eutectic Al-Si alloys with rare earth element samarium. *Journal of Materials Research*. 29, 1270-1277. <https://doi.org/10.1557/jmr.2014.113>.
- [17] Qiu, H., Yan, H., & Hu, Z. (2013). Effect of samarium (Sm) addition on the microstructures and mechanical properties of Al-7Si-0.7 Mg alloys. *Journal of Alloys and Compounds*. 567, 77-81. <https://doi.org/10.1016/j.jallcom.2013.03.050>.
- [18] Rao, Y., Yan, H., & Hu, Z.(2013). Modification of eutectic silicon and β -Al₅FeSi phases in as-cast ADC12 alloys by using samarium addition. *Journal of Rare Earths*. 31(9), 916-922. [https://doi.org/10.1016/S1002-0721\(12\)60379-2](https://doi.org/10.1016/S1002-0721(12)60379-2).
- [19] Li, Q., Li, J., Li, B., Lan, Y. & Xia, T. (2018). Effect of samarium (Sm) addition on the microstructure and tensile properties of Al-20% Si casting alloy. *International Journal of Metalcasting*. 12, 554-564. <https://doi.org/10.1007/s40962-017-0193-0>.
- [20] Ibrahim, M.F., Abdelaziz, M.H., Samuel, A.M., Doty, H. W. & Samuel, F.H. (2020). Effect of rare earth metals on the mechanical properties and fractography of Al-Si-based alloys. *International Journal of Metalcasting*. 14, 108-124. <https://doi.org/10.1007/s40962-019-00336-x>.
- [21] Mahmoud, M.G., Samuel, A.M., Doty, H.W. & Samuel, F.H. (2020). Effect of the addition of La and Ce on the solidification behavior of Al-Cu and Al-Si-Cu cast alloys. *International Journal of Metalcasting*. 14, 191-206. <https://doi.org/10.1007/s40962-019-00351-y>.

- [22] Pandee, P., Patakham, U. & Limmaneevichitr, C. (2017). Microstructural evolution and mechanical properties of Al-7Si-0.3 Mg alloys with erbium additions. *Journal of Alloys and Compounds*. 728, 844-853. <https://doi.org/10.1016/j.jallcom.2017.09.054>.
- [23] Sigworth, G.K. & Kuhn, T.A. (2007). Grain refinement of aluminum casting alloys. *International Journal of Metalcasting*. 1, 31-40. <https://doi.org/10.1007/BF03355416>.
- [24] Basak, S., Biswas, P., Patra, S., Roy, H. & Mondal, M.K., (2021). Effect of TiB₂ and Al₃Ti on the microstructure, mechanical properties and fracture behaviour of near eutectic Al-12.6 Si alloy. *International Journal of Minerals, Metallurgy and Materials*. 28(7), 1174-1185. <https://doi.org/10.1007/s12613-020-2070-8>.
- [25] Liu, Y.X., Wang, R.C., Peng, C.Q., Cai, Z.Y., Zhou, Z.H., Li, X.G. & Cao, X.Y. (2021). Microstructures and mechanical properties of in-situ TiB₂/Al-xSi-0.3 Mg composites. *Transactions of Nonferrous Metals Society of China*. 31(2), 331-344. [https://doi.org/10.1016/S1003-6326\(21\)65499-7](https://doi.org/10.1016/S1003-6326(21)65499-7).
- [26] Li, Z., Hu, Z. & Yan, H. (2016). Effect of samarium (Sm) addition on microstructure and mechanical properties of Al-5Cu alloys. *Journal of Wuhan University of Technology-Materials Science Ed.* 31(3), 624-629. <https://doi.org/10.1007/s11595-016-1420-x>.
- [27] Ferdian, D., Pratama, J. R. & Pratesa, Y. (2019). Effect of samarium on microstructure and intermetallic formation in Al-5Zn-0.5 Si alloy. *IOP Conference Series: Materials Science and Engineering*. 541(1), 012024. DOI: 10.1088/1757-899X/541/1/012024.
- [28] Lu, S.Z., & Hellawell, A. (1987). The mechanism of silicon modification in aluminum-silicon alloys: Impurity induced twinning. *Metallurgical transactions A*. 18(10), 1721-1733. <https://doi.org/10.1007/BF02646204>.
- [29] Hume-Rothery, W., Smallman, R.E., Haworth, C.W. (1969). *Structure of Metals and Alloys*. London: Institute of Metals and the Institution of Metallurgists.