

# Analysis of mechanical properties and structure of samples filled with continuous glass fiber produced in composite filament fabrication technology

Dawid MARCINIAK<sup>✉\*</sup>, Dariusz SYKUTERA<sup>✉</sup>, and Piotr CZYŻEWSKI

Faculty of Mechanical Engineering, Department of Manufacturing Techniques, Bydgoszcz University of Science and Technology, Poland

**Abstract.** The purpose of the study was to evaluate selected mechanical properties and structural characteristics of samples manufactured using composite filament fabrication (CFF) technology from Onyx material, which was filled with continuous glass fiber. Selected mechanical properties were correlated with the density of the resulting composite to determine the specific strength of the fabricated parts. The test specimens were manufactured on a Mark Two Enterprise machine (Markforged, USA) using composite filament fabrication (CFF) technology. The material used was polyamide 6.6 with a 20% short carbon fiber content with the trade name Onyx. Continuous glass fiber was used to reinforce the fabrication. The density of the manufactured samples was determined using a hydrostatic method. Methanol was used as the liquid. By determining the density of the samples, it was possible to estimate through appropriate calculations what specific strength and specific modulus the obtained composites would have. Determination of tensile and flexural strengths was carried out in accordance with ISO 527-1:2012 and ISO 178:2003. Determination of the impact tensile strength of the samples was carried out in accordance with ISO 8256, the beams were tested using the A method. Due to the high impact tensile strength, two 1 mm notches with an angle of 45° were made on the specimens. The image of the sample structure obtained by the CFF method was recorded using a CT scanner. A thermogravimetric test (TG) of the Onyx matrix material was carried out. The samples were tested approximately 72 hours after fabrication. Filling the samples with continuous glass fiber above 50% leads to a slight increase in impact resistance. The density of the composite increased by only 16% relative to the reference samples, resulting in a 389% increase in the maximum average flexural strength. Despite significant discontinuities in the structure of the produced composite, it was possible to record an increase in tensile strength and Young's modulus by 606% and 370%, respectively.

**Keywords:** CFF; composite filament fabrication; mechanical properties; structure; specific strength; specific stiffness; CT; Onyx.

## 1. INTRODUCTION

The FFF manufacturing method is one of the most widely used because of its low cost, ease of use, and the possibility of using different types of polymers. The principle of operation is based on the layer-by-layer application with a defined thickness of the extruded plastic. It is mainly used for prototyping and small-scale production [1]. Due to the mode of operation and the influence of external factors, defects such as process voids [2] or model delamination may occur in printed creations, as demonstrated in a study on the microstructure of printed parts filled with filament by Oztan *et al.*, 2018 [3]. The study by Justo *et al.*, 2018 also demonstrated the negative effect of process voids on the strength of the printed composite. The study proved lower mechanical strength of additively manufactured parts using continuous fibers than the traditional method of obtaining composites (pre-preg) [4]. In order to improve the mechanical properties of parts manufactured using FFF/CFF technology, research and development work is aimed at determining the optimal parameters of the additive manufacturing process [5], the type of finishing treatment, and reinforcing products with other

materials to create composite structures. It was proved that the addition of fibers to the polymer matrix when parts were produced using 3D printing technology increased the mechanical strength of the final products. This strength sometimes surpasses aluminum alloys and even matches titanium alloys [6]. The technology that makes it possible to produce filament-continuous fiber composites is based on the FFF manufacturing technique, in which the plastic is applied in layers by an extruder equipped with two thermostated print heads. The first is responsible for plasticizing and applying the matrix in the form of a filament, while the second applies continuous fibers in the models being built. The extruder is additionally equipped with a cutting module to cut the continuous fiber [7]. This type of composite has better mechanical properties compared to materials filled with short-cut fibers. The technology described above is offered by Markforged (USA) under the name continuous filament fabrication – CFF [8]. The materials used in the CFF technology as matrix are two polymeric materials with the trade names Nylon and Onyx created based on polyamide 6.6, they differ in that the first one is pure plastic and the second one is reinforced with short-cut carbon fibers of about 20% by weight. The diameter of the filament is 1.75 mm, and due to the hygroscopic properties of PA, it is stored in a sealed chamber with a moisture absorption system [9]. These plastics can be reinforced with four types of continuous fibers, which are glass fiber, high-temperature glass fiber, carbon fiber, and aramid fiber [10].

\*e-mail: dawid.marciniak@pbs.edu.pl

Manuscript submitted 2023-04-01, revised 2023-10-30, initially accepted for publication 2023-11-22, published in March 2024.

Publications by Goh *et al.*, 2018 and Chacon *et al.*, 2019 confirm that the matrix for continuous fibers in CFF technology is polyamide. The manufacturer does not provide such information [11, 12].

The work of Kabir *et al.*, 2020 showed that the distribution of the continuous fiber in the polyamide matrix is very heterogeneous as well as the shape of the bundle itself is not reproducible. It was estimated that there were about 1000 individual fibers in a single continuous fiber bundle [13]. In a publication by Pizzorni *et al.*, the authors demonstrated the weakening of a continuous-fiber printed structure through large voids between the paths. The experiment consisted of printing two samples and then bonding them with an adhesive. It was shown that the adhesion between the adhesive and the surface of the samples was higher than the adhesion between the printed paths [14].

In an experiment conducted by Dickson *et al.*, 2017, the performance of printed composites with continuous fiber reinforcement (carbon, aramid, and glass) was evaluated and the mechanical properties of all three composites were compared. In addition, the effect of the amount of continuous fiber, fiber arrangement, and orientation on mechanical properties was evaluated, and as a result, maximum tensile strength performance was observed in samples filled with continuous glass fiber at a fiber volume of 18%. It was shown that increasing the fiber volume yielded a slight increase in tensile strength [15]. A study by Peng *et al.*, 2019 compiled the mechanical strength results for samples without any fibers, samples filled with short fibers, and samples filled with continuous fibers. The results showed that reinforcing the specimens with both short and continuous fibers gave the best result in static tensile testing [16]. Hassani 2020, in his work, attempted to develop guidelines for designing industrial components using the additive method. He investigated the validity of using various spatial printing technologies such as polymer powder sintering, layered deposition of plasticized material, polyjet, and composite filament fabrication, and the tests conducted on a functional part demonstrated an increase in the fatigue resistance of a continuous filament-filled part [17].

The purpose of this study is to evaluate selected mechanical properties and structural characteristics of specimens produced by composite filament fabrication from Onyx material filled with continuous glass fiber and relate them to specific strength and Young's specific modulus.

## 2. METHODOLOGY

The test samples were produced using composite filament fabrication (CFF) technology with a Mark Two Enterprise 3D printer (Markforged, USA). The samples were produced from PA 66 filament containing 20 wt% short carbon fibers (SCF) with the trade name Onyx (manufacturer, country). In addition, a second type of filament, which contained continuous glass fiber (CGF), was used to reinforce the product. The geometry and dimensions of the products made using the CFF additive technique are shown in Fig. 1. The shape of the specimens was adjusted to realize static tensile and bending tests, as well as impact tensile tests in accordance with current standards. Tensile and flexural strength

determination tests were carried out using a Z030 testing machine (Zwick/Roell, Germany). The tensile speed was assumed to be  $50 \text{ mm}\cdot\text{min}^{-1}$ , and the determination of the longitudinal modulus of elasticity was carried out with a crosshead displacement speed of  $2 \text{ mm}\cdot\text{min}^{-1}$ . The determination of the impact tensile strength of the products was carried out using Method A on a HIT50 impact hammer (Zwick/Roell, Germany), in accordance with ISO 8256. Due to the potential high resistance of the filament-reinforced material to impact tensile, two notches were made on the specimens with an angle of  $45^\circ$  and a height of 1 mm. A sample size of 10 was assumed in the mechanical property determination tests.

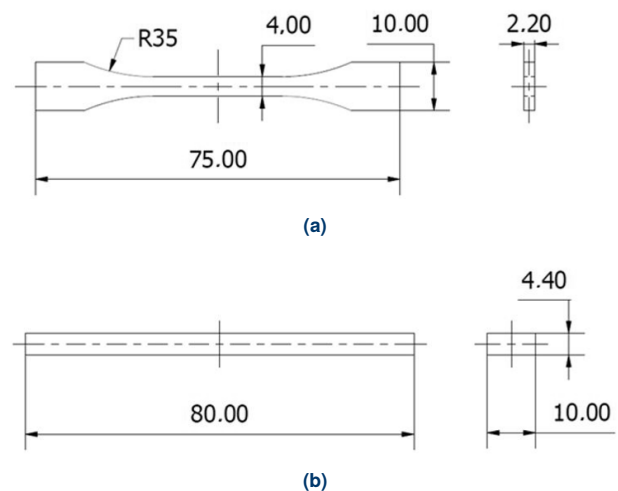


Fig. 1. Shape and dimensions of test specimens intended for (a) static tensile test; (b) impact tensile and static bending test

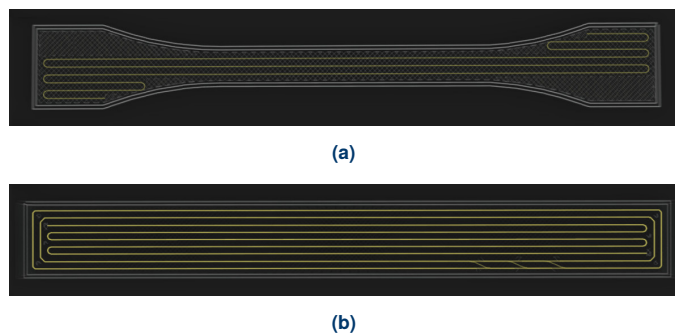
The application of the material in successive layers was carried out using two heads, whose working parameters were set independently (Table 1). The arrangement of the continuous glass fiber inside the samples is shown in Fig. 2. In each case, the continuous fiber is oriented along the  $Y$ -axis of the head movement. The contour and the top and bottom layers of the

Table 1

Process parameters for CFF fabrication of test samples

Parameters	Markforged Mark Two Enterprise
Nozzle temperature (Onyx) [ $^\circ\text{C}$ ]	275
Nozzle temperature (CGF) [ $^\circ\text{C}$ ]	235
Layer thickness [mm]	0.1
Infill density [%]	100
The orientation angle of the filament with respect to the $Y$ axis [ $^\circ$ ]	0
The sum of matrix layers at the top and bottom of the element	2
Number of matrix layers on the outline of the element – contour	2

samples were made from a filament containing short carbon fibers. The highest possible volume filling of the samples was used, guaranteeing the highest density.



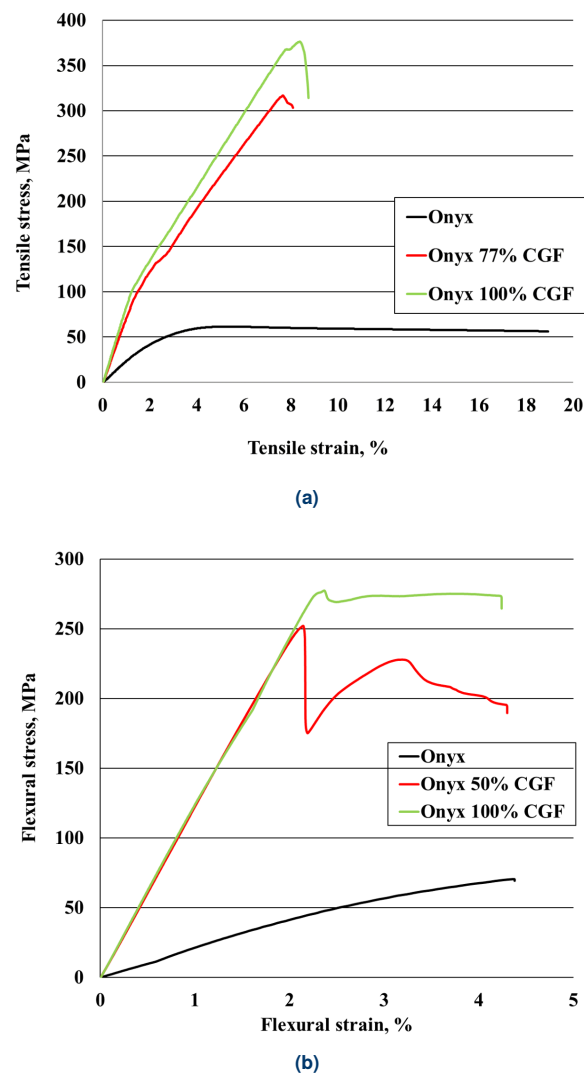
**Fig. 2.** Orientation of the filament in the sample model layer: (a) paddle-shaped sample; (b) beam-shaped sample

The density of the produced samples was determined by the hydrostatic method using an AD50 laboratory balance (Axis, Poland). Methanol with a density of  $792 \text{ kg}\cdot\text{m}^{-3}$  was used as the liquid. With the determination of the density of the samples, it was possible to calculate the specific tensile and flexural strengths and the specific Young's modulus, according to the relations presented in publications [18, 19]. In order to more comprehensively analyze the mechanical properties, structural tests were performed on the creations obtained by the CFF method using a SkyScan 1173 CT scanner (Bruker, Belgium). The following scanning parameters were adopted: source voltage 50 kV, source current 160  $\mu\text{A}$ , image pixel size 7.94  $\mu\text{m}$ , exposure 500 ms, rotation step  $0.2^\circ$ , frame averaging 3, random movement 40. The samples were examined approximately 72 hours after fabrication. In addition, a thermogravimetric (TG) test of the matrix material – Onyx was performed using a TG 209 F3 Tarsus device (Netzsch, Germany) to verify the amount of SCF. In the analysis of the results, the sample without continuous glass fiber content was described as a reference sample.

### 3. ANALYSIS OF RESULTS

A similar pattern of change in  $\sigma(\varepsilon)$  was observed for continuous glass fiber-filled specimens. The characteristics of the tensile curve for CGF-filled specimens show a high stiffness of the obtained composite and relatively low elongation. It is noted that the highest values of maximum stresses are reached during static tensile samples with maximum CGF content. The tensile curve for samples not filled with continuous fibers is different, characteristic of polyamides filled with short fibers in a small amount with a distinct necking zone (Fig. 3a). The highest value of the difference in relative elongation values was observed between samples without continuous reinforcement (ONYX) and samples filled with CGF (ONYX14). During the static bending test (Fig. 3b), a similar curve pattern of continuous reinforcement was observed, with the moment of matrix failure more evident for samples with 50% CGF content. The maximum flexural strength value was observed for 100% CGF-filled specimens.

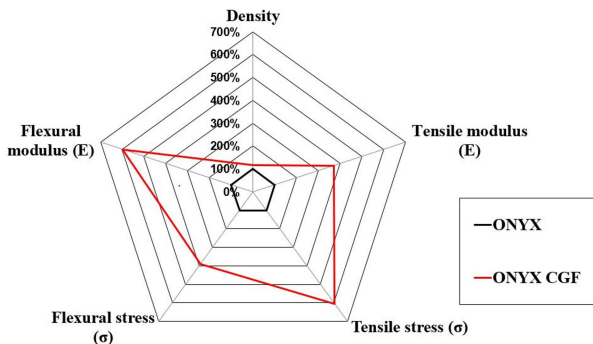
The bending curves for samples that do not contain continuous fibers are different, conducted until the conventional deflection arrow is reached, and the material did not break during the test. Very high strength values were achieved for both tensile and flexural test realizations. In the case of the material with the highest content of continuous fibers (Onyx 18),  $\sigma_m$  was almost 380 MPa, a level of values well above those characteristic of polyamide 66 products containing up to 60 wt.% of short fiber content and produced by injection molding.



**Fig. 3.** Example curves of changes in stress and elongation, which were recorded during the implementation of (a) static tensile test; (b) static bending test

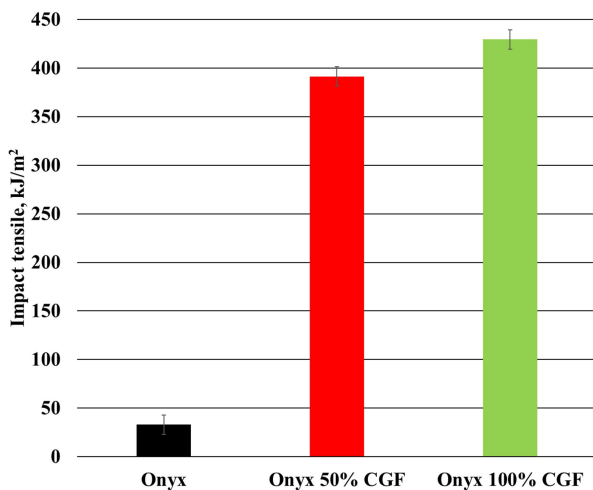
Figure 4 summarizes the results of the mechanical properties and density of the samples. The density of elements with continuous glass fiber increased by 16% relative to samples made of Onyx. The value of Young's modulus for static tensile test for CGF-filled specimens increased by 370% as compared to specimens without continuous fiber. On the other hand, the average tensile strength value was 606% higher relative to the reference samples. A 598% increase in Young's modulus was observed for

CGF-filled specimens relative to the reference material during the static bending test. A 389% increase in flexural strength was also observed in favor of the continuous fiberglass composite.



**Fig. 4.** Graphical effect of PA66 samples reinforced with continuous glass fiber (ONYX CGF) with respect to unreinforced samples. 100% marked property values for unreinforced PA66 samples

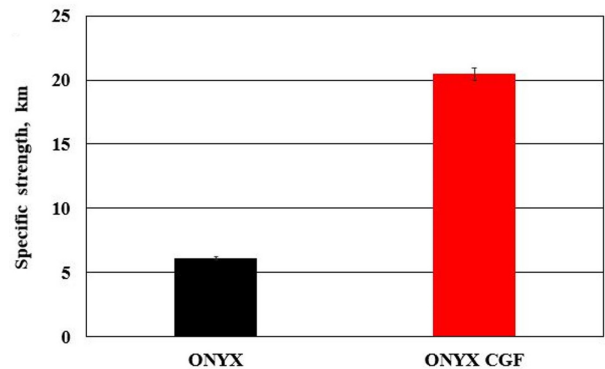
A very significant effect of reinforcing the polyamide matrix with continuous glass fibers was also found in impact tensile tests (Fig. 5). The dynamic tensile resistance of CFF specimens increases significantly in the direction of the arrangement of continuous glass fibers in their volume. Orientation of the structure by the CGF in the direction of load application (Fig. 2) results in an increase in impact tensile strength by 1189% for Onyx 50% CGF and 1305% for Onyx 100% CGF, compared to unreinforced (Onyx) specimens. At the same time, it can be noted that the difference in the maximum average values of the tested parameter between samples with continuous glass fiber content of 50% and 100%, respectively, is only 9.7%.



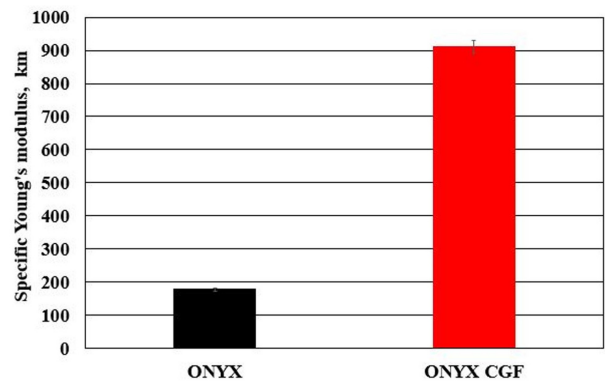
**Fig. 5.** Impact tensile values for reference specimens and those with continuous glass fiber content

This means that already with less filling of the polyamide matrix with continuous fibers it was possible to achieve such a significant improvement of this parameter, and this means that it is unjustified to use the maximum continuous fiber content. A hydrostatic density test of the fabricated composite samples

was used to determine the specific strength and specific Young's modulus (Fig. 6). A significant increase in the values of specific strength and specific Young's modulus relative to unreinforced samples was observed, by 335.2% and 510.5%, respectively. The specific strength values obtained for Onyx CGF are on the level of titanium alloys and higher than those for aluminum alloys [19]. Despite the hybrid structure, the results obtained are characterized by high repeatability, as evidenced by the low value of the standard deviation.



(a)



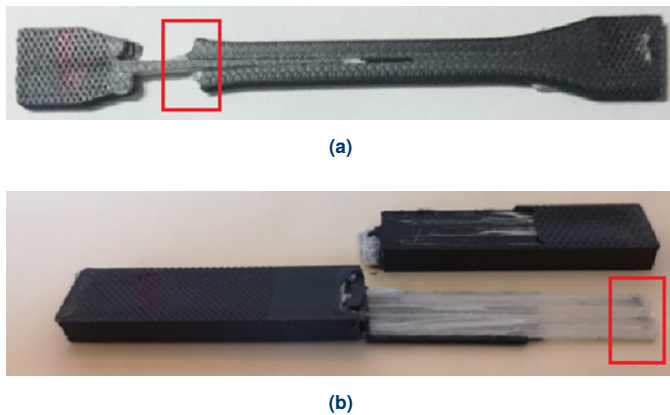
(b)

**Fig. 6.** Value of (a) specific strength; (b) specific Young's modulus

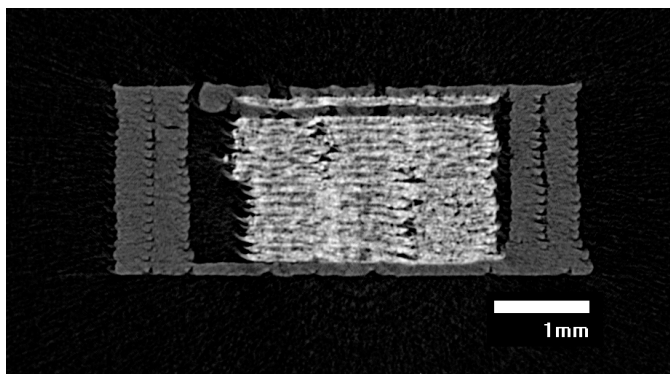
Figure 7 presents sample specimens after destructive testing. As can be observed, the core of the specimens did not break completely, and in a part of the measuring volume, there was delamination between the layers containing the filament and a decrease in adhesion between the matrix (Onyx) and the filler (CGF) (red boxes). Based on the CT images, it was concluded that the observed effects are the result of a technological defect in the manufacturing method itself. There are technological voids between the individual paths, which are natural places of weakness in the cross-section of the samples (Fig. 8). Extremely significant discontinuities can be seen in the structure of the fabricated composite in the contour-core area. The presence of small technological voids between the contours of the specimen was also found. The reason for such large discontinuities in the structure can be seen in the way individual material paths are laid out, which is forced by the software cutting into layers. An-



other element influencing the formation of significant areas of discontinuity is the different diameters of the nozzles applying the material so that the produced paths can have different widths.

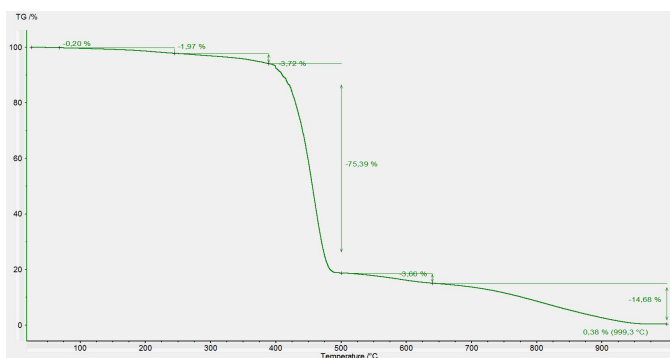


**Fig. 7.** Example images of specimen fractures after testing: (a) static tensile test; (b) impact tensile test



**Fig. 8.** Microtomographic image of a cross-section of an example specimen containing continuous CGF glass fiber (black fields between light (continuous glass fiber) and gray fields (matrix material – Onyx))

In order to identify the amount of short SCF carbon fibers in the matrix material, a thermogravimetric study was conducted (Fig. 9). It was found that the content of these fibers in the PA66 (Onyx) matrix is about 18 wt%, which is slightly lower than the amount declared by the manufacturer of the filament.



**Fig. 9.** Changes in the mass of the matrix material (Onyx) recorded on the TG curve

#### 4. CONCLUSIONS

It was found that the reinforcement of the PA66 matrix with directed continuous glass fiber for additively manufactured CFF samples significantly improves their mechanical properties, determined under both static and dynamic conditions. The obtained tensile and flexural strengths for this composite are close to those of aluminum alloys and can be compared to those of aluminum alloys, making composite filament fabrication technology an acceptable alternative to conventional light alloy processing methods.

It can be observed that filling the samples with continuous glass fiber above 50 wt.% results in a slight increase in impact resistance. The slight increase in density of reinforced materials compared to unfilled (Onyx) is accompanied by a very significant increase in strength characteristics.

One of the biggest limitations of CFF technology is the inability to connect the printed layers three-dimensionally, resulting in a high tendency for delamination (delamination) of successive layers of the composite. Despite the significant discontinuities in the structure of the fabricated PA66 CFG composite, an increase in tensile strength and Young's modulus by 606% and 370%, respectively, was achieved compared to samples made from PA66 CF20 matrix material.

Through modifications in the design and control of the head operation, it is possible to reduce process voids at the contour-core boundary and those located in the core part of samples obtained by incremental CFF technology. Such measures can lead to improvements in the already very good mechanical properties of sandwich parts, making them an alternative to known structural materials such as aluminum alloys and perhaps even titanium.

#### REFERENCES

- [1] P. Czyżewski *et al.*, “Secondary use of ABS co-polymer recycles for the manufacture of structural elements using the FFF technology,” *Rapid Prototyping J.*, vol. 24, no. 9, pp. 1447–1454, 2018, doi: [10.1108/RPJ-03-2017-0042](https://doi.org/10.1108/RPJ-03-2017-0042).
- [2] M. Mohammadzadeh, A. Imeri, I. Fidan, and M. Elkelany, “3D printed fiber reinforced polymer composites – Structural analysis,” *Compos. Part B*, vol. 175, p. 107112, 2019, doi: [10.1016/j.compositesb.2019.107112](https://doi.org/10.1016/j.compositesb.2019.107112).
- [3] C. Oztan *et al.*, “Microstructure and mechanical properties of three dimensional-printed continuous fiber composites,” *J. Compos. Mater.*, vol. 53, no. 2, pp. 271–280, 2019, doi: [10.1177/0021998318781938](https://doi.org/10.1177/0021998318781938).
- [4] J. Justo, L. Távora, L. Garcia-Guzman, and F. Paris, “Characterization of 3D printed long fibre reinforced composites,” *Compos. Struct.*, vol. 185, pp. 537–548, 2018, doi: [10.1016/j.compstruct.2017.11.052](https://doi.org/10.1016/j.compstruct.2017.11.052).
- [5] C. Yang, X. Tian, T. Liu, Y. Cao, and D. Li, “3D printing for continuous fiber reinforced thermoplastic composites: mechanism and performance,” *Rapid Prototyping J.*, vol. 23, no. 1, pp. 209–215, 2017, doi: [10.1108/RPJ-08-2015-0098](https://doi.org/10.1108/RPJ-08-2015-0098).
- [6] L. Pyl, K.A. Kalteremidou, and D. Van Hemelrijck, “Exploration of the design freedom of 3D printed continuous fibre-reinforced polymers in open-hole tensile strength tests,” *Compos.*

- Sci. Technol.*, vol. 171, pp. 135–151, 2019, doi: [10.1016/j.compscitech.2018.12.021](https://doi.org/10.1016/j.compscitech.2018.12.021).
- [7] H. Al Abadi, H.-T. Thai, V. Paton-Cole, and V.I. Patel, “Elastic properties of 3D printed fibre-reinforced structures,” *Compos. Struct.*, vol. 193, pp. 8–18, 2018, doi: [10.1016/j.compstruct.2018.03.051](https://doi.org/10.1016/j.compstruct.2018.03.051).
- [8] Markforged, [Online] Available at: <https://markforged.com/> (accessed: 20 November 2022),
- [9] M. Araya-Calvo *et al.*, “Evaluation of compressive and flexural properties of continuous fiber fabrication additive manufacturing technology,” *Addit. Manuf.*, vol. 22, pp. 157–164, 2018, doi: [10.1016/j.addma.2018.05.007](https://doi.org/10.1016/j.addma.2018.05.007).
- [10] O. Gonzalez-Estrada, A. Pertuz, and J. Diaz, “Monotonic load datasets for additively manufactured thermoplastic reinforced composites,” *Data Brief*, vol. 29, p. 105295, 2020, doi: [10.1016/j.dib.2020.105295](https://doi.org/10.1016/j.dib.2020.105295).
- [11] G.D. Goh *et al.*, “Characterization of mechanical properties and fracture mode of additively manufactured carbon fiber and glass fiber reinforced thermoplastics,” *Mater. Des.*, vol. 137, pp. 79–89, 2017, doi: [10.1016/j.matdes.2017.10.021](https://doi.org/10.1016/j.matdes.2017.10.021).
- [12] J.M. Chacon, M.A. Caminero, P.J. Nunez, I. Garcia-Moreno, and J.M. Reverte, “Additive manufacturing of continuous fiber reinforced thermoplastic composites using fused deposition modelling: Effect of process parameters on mechanical properties,” *Compos. Sci. Technol.*, vol. 181, p. 107688, 2019, doi: [10.1016/j.compscitech.2019.107688](https://doi.org/10.1016/j.compscitech.2019.107688).
- [13] F. Kabir, K. Mathur, and A.F. Seyam, “A critical review on 3D printed continuous fiber-reinforced composites: History, mechanism, materials and properties,” *Compos. Struct.*, vol. 232, p. 111476, 2020, doi: [10.1016/j.compstruct.2019.111476](https://doi.org/10.1016/j.compstruct.2019.111476).
- [14] M. Pizzorni, A. Parmiggiani, and M. Prato, “Adhesive bonding of a mixed short and continuous carbon-fiber-reinforced Nylon-6 composite made via fused filament fabrication,” *Int. J. Adhes. Adhes.*, vol. 107, p. 102856, 2021, doi: [10.1016/j.ijadhadh.2021.102856](https://doi.org/10.1016/j.ijadhadh.2021.102856).
- [15] A.N. Dickson, J.N. Barry, K.A. McDonnell, and D.P. Dowling, “Fabrication of continuous carbon, glass and Kevlar fibre reinforced polymer composites using additive manufacturing,” *Addit. Manuf.*, vol. 16, pp. 146–152, 2017, doi: [10.1016/j.addma.2017.06.004](https://doi.org/10.1016/j.addma.2017.06.004).
- [16] Y. Peng, Y. Wu, K. Wang, G. Gao, and S. Ahzi, “Synergistic reinforcement of polyamidebased composites by combination of short and continuous carbon fibers via fused filament fabrication,” *Compos. Struct.*, vol. 207, pp. 232–239, 2018, doi: [10.1016/j.compstruct.2018.09.014](https://doi.org/10.1016/j.compstruct.2018.09.014).
- [17] V. Hassani, “An investigation of additive manufacturing technologies for development of end-use components: A case study,” *Int. J. Pressure Vessels Pip.*, vol. 187, p. 104171, 2020, doi: [10.1016/j.ijpvp.2020.104171](https://doi.org/10.1016/j.ijpvp.2020.104171).
- [18] D. Sykutera, P. Czyżewski, and P. Szewczykowski, “High-Performance of a Thick-Walled Polyamide Composite Produced by Microcellular Injection Molding,” *Materials*, vol. 14, p. 4199, 2021, doi: [10.3390/ma14154199](https://doi.org/10.3390/ma14154199).
- [19] P. Mayer and J.W. Kaczmar, “Properties and applications of carbon and glass fibers,” *Plastics and Chemistry*, vol. 6, 2008.