

MAREK GAWOR*, JERZY LITWINISZYN*, JÓZEF RYSZ*, ANDRZEJ Z. SMOLARSKI*

ROCK AND GAS OUTBURSTS

WYRZUTY SKALNO-GAZOWE

This paper presents the studies and research into rock and gas outbursts phenomena. A continuous medium in which rarefaction shock waves can propagate is taken to be the model of such a rock-gas medium. The results of laboratory research into “mini-outbursts” of coal briquettes saturated with CO₂, N₂, He are presented. These provide valuable information on time-space correlations between certain parameters, such as pressure, temperature, deformations — those that characterise the medium during outburst initiation and reveal the emerging disc structure of the medium.

Key words: rock and gas outbursts, rarefaction shock waves, hard coal.

Praca przedstawia badania nad zjawiskiem nagłych wyrzutów ośrodka skalno-gazowego. Występujące w naturze zjawiska wyrzutów z wnętrza ziemi mas skalno-gazowych, jak np. wybuchy wulkanów, gejzery, gigantyczne wyrzuty wody nasyconej CO₂ z jezior wypełniających dawne kratery wulkaniczne znane są od dawna. Naruszenie działalności górniczą pierwotnego stanu górotworu, w którym znajdują się substancje podlegające przemianom fazowym, powoduje niekiedy wyrzuty mas skalno-gazowych.

Procesy termodynamiczne towarzyszące tym zjawiskom odbywają się w warunkach nierównowagi termodynamicznej.

Jakościowy obraz zależności $p = p(V)$ przedstawia rys. 1. W fundamentalnej pracy Bethe (1942) podał równanie (1), które można zapisać w postaci (2). W obszarze parametrów termodynamicznych, dla których spełniona jest nierówność $\left(\frac{\partial^2 p}{\partial V^2}\right)_s < 0$, możliwa jest generacja i propagacja rozrzedzeniowych fal uderzeniowych. Thompson i Lambrakis (1973) zakomunikowali o odkryciu pewnych substancji spełniających powyższy warunek. Podane przez Bethego równanie i fakt, że ciepło właściwe węgla deponującego CO₂ i CH₄ jest znacznie większe niż ciepło właściwe gazów, nasuwa myśl, że znak pochodnej $\left(\frac{\partial^2 p}{\partial V^2}\right)$ jest taki sam jak pochodnej $\left(\frac{\partial^2 p}{\partial V^2}\right)$. Ponieważ badania (rys. 1)

* INSTYTUT MECHANIKI GÓROTWORU, POLSKA AKADEMIA NAUK, 30-059 KRAKÓW, UL. REYMONTA 27

wskazywały, że w pewnych obszarach spełniona jest zależność $\left(\frac{\partial^2 p}{\partial V^2}\right)_T < 0$, a więc w ośrodku mogą się generować i propagować rozrzedzeniowe fale uderzeniowe.

W przyjętym modelu założono, że węgiel z zawartymi w nim substancjami jest ośrodkiem ciągłym tworzącym tzw. roztwór stały. Stosując zasadę zachowania masy i pędu oraz równania konstytutywne $p = p(V)$ o własności $\left(\frac{\partial^2 p}{\partial V^2}\right)_s < 0$ otrzymano układ nieliniowych równań hiperbolicznych, który w przypadku jednowymiarowym przyjmuje postać (3). Równania konstytutywne w ogólnym przypadku mają postać (4); zakładając nieobecność procesów relaksacyjnych, brak pamięci materiału i ograniczając się tylko do zmian objętości, równania konstytutywne redukują się do równania stanu (5). Na granicy obszaru można je zapisać w postaci (6), przyjmując za Łydźbą (Łydźba 1990) funkcję $F(p)$ w postaci (6). Dla zadanych warunków brzegowo-początkowych odpowiadających warunkom w niżej przedstawionych eksperymentach uzyskano rozwiązanie w postaci rozrzedzeniowej fali uderzeniowej opisującej ciśnienie porowe w ośrodku. W świetle tego modelu inicjacja wyrzutu jest skutkiem generowanej serii następujących po sobie rozrzedzeniowych fal uderzeniowych, w wyniku działania których powstaje zbiór plastrów o płaszczyznach podziału równoległych do frontu tych fal (Litwiniszyn 1994).

Wykonano badania, których celem było potwierdzenie warstwowego sposobu rozpadu węgla oraz wpływu desorpcji na charakter tego procesu. Schemat eksperymentu przedstawia rys. 3. Rys. 4 przedstawia obrazy rozpadającego się brykietu o porowatości 16% nasyconego azotem (a) i dwutlenkiem węgla (b) do ciśnienia 0,6 MPa, rozprężanego do ciśnienia atmosferycznego. Rys. 5 przedstawia zależność położenia płatków rozpadającego się brykietu od czasu dla obu gazów. Wykonane zdjęcia potwierdziły pogląd o warstwowym mechanizmie rozpadu brykietu.

W celu weryfikacji hipotezy, że przyczyną powstawania płatków podczas wyrzutu jest uderzeniowa fala rozrzedzeniowa, wykonano eksperymenty, w których w czasie destrukcji brykietu mierzono ciśnienie gazu, odkształcenie i jego temperaturę. Ciśnienie mierzono za pomocą piezorezystancyjnych przetworników ciśnienia, do pomiaru temperatury posłużono się termoparami umieszczonymi wewnątrz próbki. Lokalne odkształcenie mierzono za pomocą tensometrów węglowych o oryginalnej konstrukcji (Rysz 1996). Rys. 7 przedstawia przebiegi ciśnienia, odkształcenia i temperatury podczas eksperymentu z rozpadem brykietu nasączonego dwutlenkiem węgla, przebiegi eksperymentu z helem przedstawiono na rys. 9. Rys. 8 przedstawia zmiany ciśnienia gazu i ich pochodne po czasie. Im dalej od czoła brykietu, tym bezwzględna wartość pochodnej ciśnienia jest większa, co świadczy o rosnącym nachyleniu spadku ciśnienia. Może to stanowić potwierdzenie hipotezy o formowaniu się fali uderzeniowej w brykiecie.

Słowa kluczowe: wyrzuty gazów i skał, rozrzedzeniowe fale uderzeniowe, węgiel kamienny.

1. Introduction

Natural phenomena of sudden gas and rock mass outbursts, such as volcano eruptions, geysers, huge bursts of water saturated with CO_2 , out of the reservoirs in former volcano craters have been known for a long time. As mining activities upset the natural balance in the rock mass containing the substances that undergo phase transitions, the outbursts of rock and gas may occur. Their occurrences in mines

have been recorded for more than 150 years. Attempts have been made to provide an adequate explanation of these processes. A monograph (Lama & Bodziony, 1996) presents the state of the art at that time. Increasing frequency of outburst occurrence after the II World War called for still more extensive research.

Theoretical bases have been considered, and the tests both "in situ" and in laboratory conditions have been run. These were based on physical and chemical processes involved in outbursts. An outburst takes a wave-like course. The surface propagating inside the rock mass in the region where we can observe strong and weak discontinuities of thermodynamic parameters and structures that make up the medium.

Until the medium is destroyed, its model is taken to be a continuous medium containing substances that undergo phase transitions. Such medium is regarded as a solid solution (Ettinger, 1990). To describe the processes taking place in those media one applies the laws of mass, momentum and energy conservation, constitutive equations and the second law of thermodynamics. The latter means that entropy generation due to an outburst must not be negative.

2. Rarefaction shock waves

Thermodynamic processes that accompany the outbursts take place in the conditions of thermodynamic unbalance. They proceed at a high rate through shifting regions of a multi-phase medium (Smolarski, 1993). That makes experimental research somewhat difficult. Besides, there is no adequate data on this point. The research is concerned with quasi-static and iso-thermal states (Moffat & Weale, 1955), (Czapliński & Ceglarska-Stefańska, 1990). It reveals the relationship between the specific volume V of coal samples saturated with CO_2 , CH_4 , N_2 , and the confining pressure p to which they were subjected.

This relationship $p = p(V)$ for some coal samples is presented qualitatively in Fig. 1.

There are two distinct ranges of values:

$$\text{I } p_a < p < p_b; V_a < V < V_b; \text{ where } \left(\frac{\partial p}{\partial V} \right)_T > 0$$

$$\text{II } p_b < p < p_c; V_c < V < V_b; \text{ where } \left(\frac{\partial p}{\partial V} \right)_T < 0, \left(\frac{\partial^2 p}{\partial V^2} \right)_T < 0,$$

where T stands for temperature; the quantities $(\sim)_T$ indicate isothermal state, for $T = \text{const}$.

At the (b) point where $p = p_b$, $V = V_b$ the sign of the magnitude of $\left(\frac{\partial p}{\partial V} \right)_T$ is changed. When the magnitudes of parameters belong to the I domain, the processes

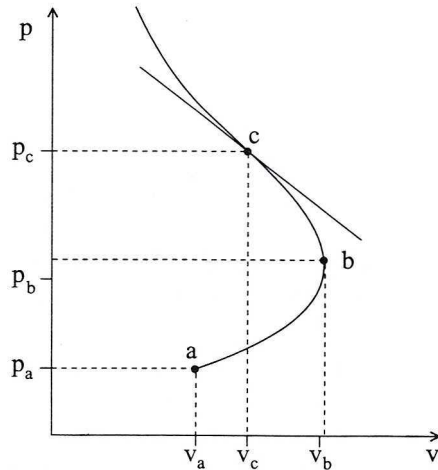

Fig. 1. The pressure p vs specific volume V for coal samples saturated with gas

of diffusion and sorption prove to be of primary importance and the sample swells. Throughout the parameter range II, where $p > p_b$ and $V < V_b$ the sample shrinks as confining pressure increases and the specific volume decreases.

In his fundamental work *Bethe* (1942) formulated the following equation:

$$\left(\frac{\partial^2 p}{\partial V^2}\right)_S = \frac{1}{C_V} \left\{ -3T \left(\frac{\partial p}{\partial V}\right)_T \frac{\partial^2 p}{\partial V \partial T} + \frac{3T}{C_V} \left(\frac{\partial p}{\partial V}\right)^2 \left(\frac{\partial C_V}{\partial V}\right)_T + \frac{T}{C_V} \left(\frac{\partial p}{\partial T}\right)_V^3 \times \right. \\ \left. \times \left[1 - \frac{T}{C_V} \left(\frac{\partial C_V}{\partial T}\right)_V \right] \right\} + \left(\frac{\partial^2 p}{\partial V^2}\right)_T, \quad (1)$$

which can be rewritten as:

$$\left(\frac{\partial^2 p}{\partial V^2}\right)_S = \left(\frac{\partial^2 p}{\partial V^2}\right)_T + 0 \left(C_V^{-1}\right), \quad (2)$$

where C_V stands for the specific heat at constant volume, and the S index denotes that the $\left(\frac{\partial^2 p}{\partial V^2}\right)_S$ derivative refers to the state of constant entropy S .

In accordance with the second law of thermodynamics for the range of thermodynamic parameters for which the inequality $\left(\frac{\partial^2 p}{\partial V^2}\right)_S > 0$ is satisfied for a given medium, there may only propagate compression shock waves. The latter inequality does not result from thermodynamic relations, and hence the negative value of $\left(\frac{\partial^2 p}{\partial V^2}\right)_S$ may appear. *Zeldovich* and *Raizer* (1967) predicted that the

derivative $\left(\frac{\partial^2 p}{\partial V^2}\right)_s$ might have a negative value for those ranges of thermodynamic parameters whose characterise phase transition processes (i. e. close to thermodynamic parameters in the neighbourhood of liquid-gas critical points).

According to the second law of thermodynamics the rarefaction shock waves may be generated and propagated in the media whose thermodynamic parameters are located within such a range that the condition $\left(\frac{\partial^2 p}{\partial V^2}\right)_s < 0$ is satisfied.

In the early 70s Thompson and Lambakis (1973) announced that they had discovered certain substances that would satisfy the condition $\left(\frac{\partial^2 p}{\partial V^2}\right)_s < 0$. Afterwards, there appeared numerous publications on the subject of retrograde substances — that is those that satisfy the latter inequality. The existence of rarefaction shock waves was then experimentally verified.

Thompson called $\left(\frac{\partial^2 p}{\partial V^2}\right)_s$ the fundamental derivative taking into account that its sign determines the type of the shock wave being generated.

The equation suggested by Bethe as well as the fact that specific heat C_v of coal accumulating CO_2 , and CH_4 is more significant than that of the gases lead to an assumption that the sign of the fundamental derivative for certain ranges of thermodynamic parameters is the same as that of the derivative $\left(\frac{\partial^2 p}{\partial V^2}\right)_T$. Fig. 1

reveals that for a certain range of parameters the inequality $\left(\frac{\partial^2 p}{\partial V^2}\right)_T < 0$ is satisfied; therefore the medium shows retrograde properties and rarefaction shock waves can be generated and propagate in it. These processes were then extensively studied.

In the accepted model describing these processes it has been assumed that coal with the accumulated substance is a continuous medium, forming a solid solution. Basing on the laws of mass and momentum conservation and the constitutive equation $p = p(V)$ where $\left(\frac{\partial^2 p}{\partial V^2}\right)_s < 0$ — which indicates a retrograde medium, a system of non-linear, hyperbolic equations was obtained.

Generally, constitutive equations for continuous materials made of two components are given by the following relation:

$$\Phi_m(\sigma^{ik}, \varepsilon_{ik}, p, c, \dot{\sigma}^{ik}, \dot{\varepsilon}_{ik}, \dot{p}, \dot{c}, \partial_j \varepsilon_{ik}, \partial_j p, \partial_j c, \int_{-\infty}^t \sigma^{ik} ds, \dots, U, S) = 0, \quad (3)$$

where σ^{ik} — stress tensor, ε_{ik} — deformation tensor, c — concentration, U — integral energy.

The function Φ_m is determined experimentally, following some general rules: it must be objective (invariable in relation to Galilee transformations), tensors must be

homogeneous (all the components must be of the same rank), entropy generation must not be negative.

In specific cases, once we assumed that relaxing processes did not take place, that the materials had no memory and our considerations were limited to volume changes, the constitutive equations would be thereby reduced to the equation of state:

$$\varepsilon = \frac{1}{3} \varepsilon_{ik} \delta^{ik} = \frac{1-\eta}{K} \sigma - \frac{\lambda}{K} p + F(p) + \beta \Delta T, \quad (4)$$

where δ^{ik} — delta function; T — temperature; K , λ , η , β — material constant.

When gas pressure at the limiting point should be p , then $\sigma = -p$ and the following correlation is obtained:

$$\varepsilon = -\frac{p}{K} + F(p) + \beta \Delta T, \quad (5)$$

where $F(p)$ is the function describing the extent of swelling in relation to the amount of sorbed gas. According to Ły d ź b a (1990) it can be written as:

$$F(p) = (C + D \ln p) \frac{Ap}{B + p}, \quad (6)$$

where A , B , C , D — material constant.

Considering the problem as one-dimensional, those equations represented in time-space Cartesian co-ordinates system t , x will be as follows:

$$\left. \begin{aligned} \frac{\partial p}{\partial t} + u \frac{\partial p}{\partial x} + \varrho c^2 \frac{\partial u}{\partial x} &= 0 \\ \frac{\partial u}{\partial t} + u \frac{\partial u}{\partial x} + \frac{1}{\varrho} \frac{\partial p}{\partial x} &= 0 \end{aligned} \right\} \quad (7)$$

where $c^2 = \left(\frac{dp}{d\varrho} \right)_s = -V \left(\frac{dp}{dV} \right)_s$, $u = u(x, t)$ — velocity of the medium relative to the x -axis, $\varrho = \frac{1}{V}$.

The initial-boundary conditions being set as corresponding to those prevailing during the experiments discussed below, the solution was obtained in the form of a simple, rarefaction shock wave describing the pore pressure inside the medium. In view of the model, outburst initiation is brought about by a series of simple, rarefaction shock waves being generated. These will produce a series of disc-shaped slices, their separating planes being parallel to the front of wave (Litwiniszyn, 1994).

The situation bears an analogy to that when suddenly a green traffic light is switched on while the cars waiting in the line are beginning to move forward, one by one. The boundary line between the cars still waiting and those already moving propagates in the direction opposite to that of the traffic movement (Fig. 2).

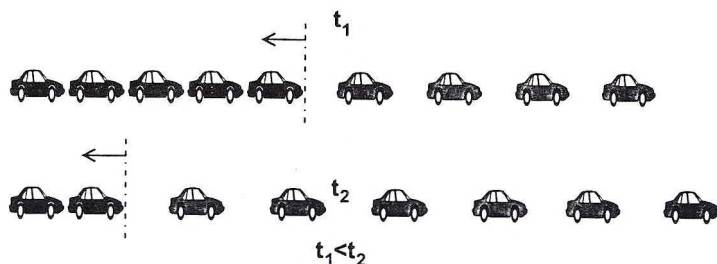

Fig. 2. A rarefaction shock wave compared to a traffic problem, as an analogy to an outburst

3. Recording the briquette destruction

Experimental studies of the mechanisms involved in an outburst and its initiations have become more intensive in the last few years. The researchers analyse the processes of coal dust briquette destruction (Bodziony et al., 1990) and glued, mortar-like samples (Ujihira et al., 1985). Properly spaced transducers of gas pressure and skeleton deformations provide the information on the rate at which sample destruction proceeds. During the tests described by Ujihira one wall of the test chamber was transparent, so the process of sample destruction was recorded, using a fast camera. While analysing destroyed samples, the researchers found many thin layers parallel to the front surface of the samples.

Tests were run to verify that coal destruction would proceed layer by layer, and to determine the effects of gas desorption on the way the destruction would proceed (Gawor et al., 1994). The experiments were run using the briquettes made of coal dust from outburst-prone seams (Fig. 3). Briquettes (1) were formed using a hand-operated screw press (3) inside the expansion pipe — a thick-walled, steel cylinder with its inner diameter 20.8 mm. After the briquette was formed, the piston (2) that pressed the coal dust remained inside the pipe. At the opposite end of the pipe there was a seat of a metal membrane (5) together with the membrane-cutting device (6). Between the membrane and the front part of the briquette there was a piezoelectric pressure transducer (7). Air was removed from coal using a rotary pump (9), then the coal was saturated with gas from the bottle (10), through a connector pipe with a valve. In the side wall of the expansion pipe there was a corundum window (4) enabling the observations of the briquette surface. The area of briquette surface available for observation was 7.5 mm × 27 mm. While pictures were being taken at the rate of 5000/sec using a camera (11), briquette surface was lit by a halogen lamp (12).

After gas pressure dropped rapidly, the briquette was destroyed. Its broken parts and the gas filling its pores moved to the decompression chamber (13); the air having been already removed out of it. In the side wall of the expansion pipe there was a pressure transducer to measure the pressure of gas released during briquette destruction. In the upper part there was a knife pusher pass.

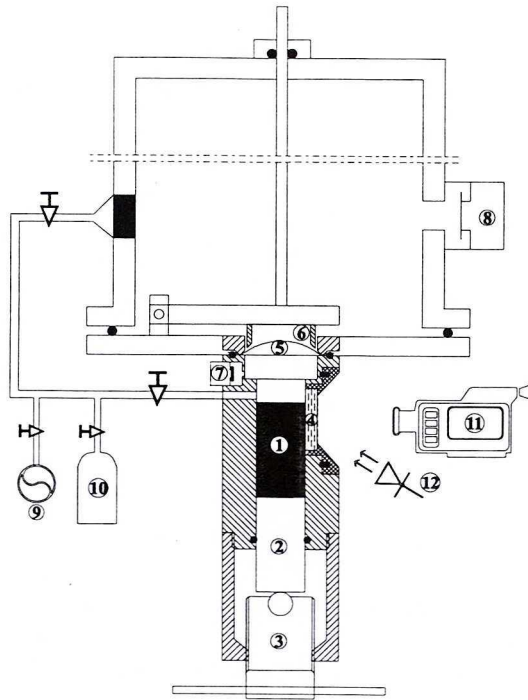

Fig. 3. Experimental setup for recording the coal briquette destruction

Briquettes were made of coal dust with the grain size below 0.2 mm. It was taken from an outburst-prone seam in the coal mine Nowa Ruda (4th category of mining hazard). Total density of coal was $\rho = 1.52 \text{ g/cm}^3$. To enhance the contrast between coal and emerging cracks (as black cracks were invisible against coal), briquette surface was covered with some indicators — substances well reflecting light (0.1 g of titanium oxide per 1 g of coal).

Picture 4 presents processes of destroying briquettes with the porosity of 16% previously saturated with (a) nitrogen and (b) carbon dioxide up to the pressure of 0.6 MPa (and decompressed down to the atmospheric pressure). Time interval between subsequent pictures was 0.18 ms. During an outburst subsequent cracks parallel to briquette front part was formed. Very soon these grew bigger. Slices (i. e. the layers of coal) were torn off the briquette and moved towards the pipe outlet. One could clearly see the differences in appearance of slices and behaviour during these two experiments. In the course of experiments using nitrogen the slices had the thickness of 1.3 mm. Actually they would not change their shape while moving towards the pipe outlet. The briquette saturated with carbon dioxide produced the slices 0.4–0.8 mm thick. They moved faster than those in the tests with nitrogen. As soon as they were torn off the briquette, they broke into still tinier fragments. It was extremely difficult to follow their movements as they quickly went out of sight.

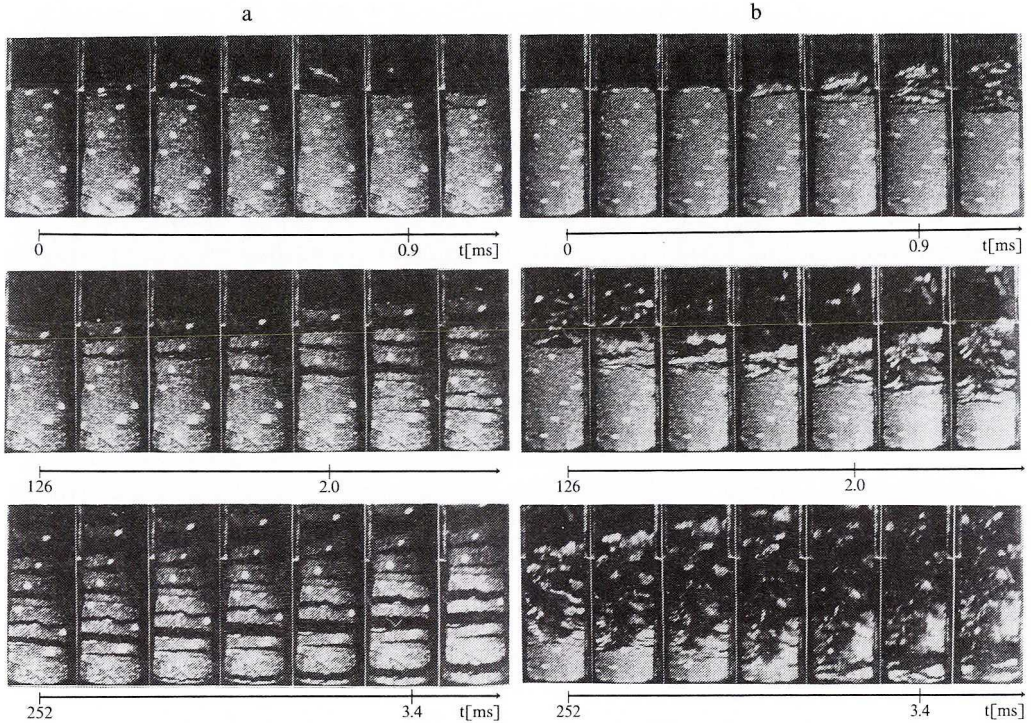

Fig. 4. Destruction of the briquette with the porosity of 16% saturated with (a) nitrogen and (b) carbon dioxide up to the pressure of 0.6 MPa

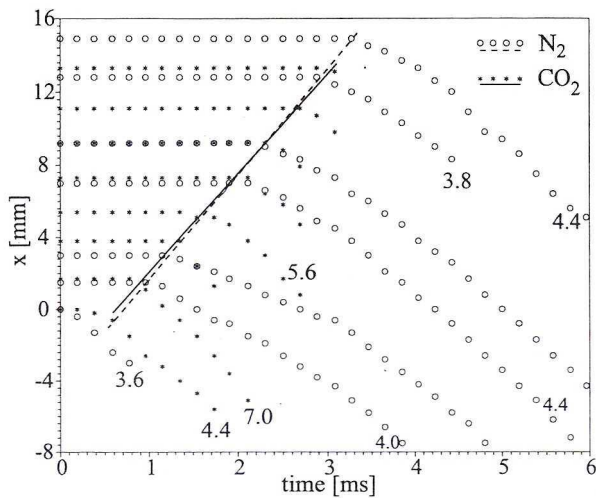

Fig. 5. A slices movement during briquette destruction (on the ground of Fig. 4)

Fig. 5 presents time variations of positions of briquette slices during the two tests. The co-ordinate $x = 0$ corresponds to the initial position of the front part of the

briquette. The motion of subsequent layer, accelerated at first, then became uniform, with the speed of about 4 m/s in the tests with N_2 . It is much more difficult to determine the speed of slices during the tests with CO_2 , as they quickly get out of sight. We can calculate their speed only during the initial phase of their movement, that is for the time of less than 1 ms (during the tests with nitrogen this time is as high as 4 ms). Thus calculated values depend on the length of recording time. For short recording time these velocities are 3.6–4.5 m/s, and up to 6.6 m/s for longer time periods.

Combining plotted points representing the instants at which subsequent layers were torn off and set in motion, we get a curve whose inclination is the measure of briquette destruction rate. Briquette destruction rate calculated on the base of the inclination of straight-line section equals 5.8 m/s in the tests with nitrogen (a broken line) and 5.4 m/s for carbon dioxide (a continuous line).

The photographs thus taken verify the hypothesis that briquette destruction proceeds layer by layer. This mechanism may be caused by a rarefaction shock wave, as suggested. To find out whether it is possible that such a wave be generated in the tested briquettes, it is necessary to determine the constitutive equations for coal saturated with gas. Special attention should be given to whether the pressure ranges as applied in those experiments make it possible for the value of the fundamental derivative to be negative.

The experiments reveal that briquette destruction rate hardly depends on the type of saturating gas. It significantly increases with increase of porosity and pressure difference between the saturation pressure and that of decompression.

4. Measurements of pressure, temperature and deformations

To verify the hypothesis that layered structure is formed during an outburst due to rarefaction shock waves, tests were run whereby gas pressure, briquette deformations and temperature were measured while the briquette was destroyed. Briquettes were formed as described earlier.

In the side surface of the expansion pipe there are some passes in which the following devices were fitted:

1. Piezoelectric pressure transducers that measured the absolute pressure of gas saturating the briquette. To reduce the space between the transducer steel membrane and the coal surface, the pass was filled in with silicone grease.

2. While the briquette was being formed, constantan-manganine thermocouples made of the wire 0.1 mm thick were placed close to the axis (Fig. 6). To reduce the time constant of the thermometer and to increase heat exchange, the end part of the thermocouple, about 3 mm in length from the junction, was flattened to the thickness of about 10 μm .

3. To measure local deformations of the briquette and to monitor the very instant of briquette destruction there were coal strain gauges placed inside the briquette. Between two metal electrodes about 3 mm in diameter, 2 mm away from one another

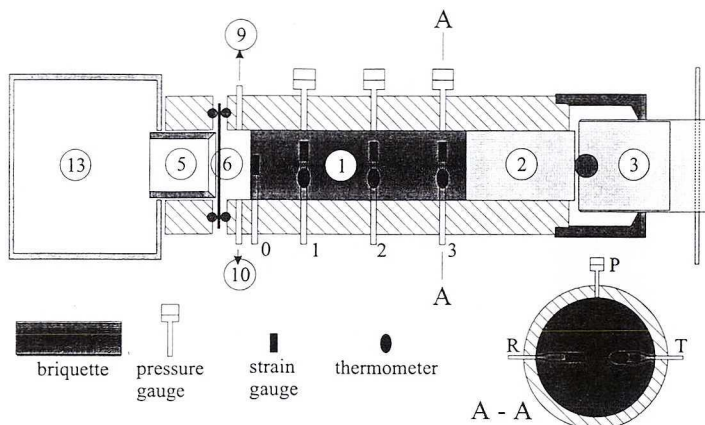

Fig. 6. Schematic of experimental procedures to measure pressure, deformations and temperature during coal briquette destruction

and perpendicular to the briquette axis there was some coal dust made of coal grains (out of which the briquette was formed) mixed with the powder from coal electrodes. These were pressed while the briquette was being formed. Coal swelling resulted in an increase of the distance between the electrodes which in turn brought about an increase in resistance. When the briquette was broken, electric conduction became impossible at all (as resistance increased up to ∞).

Sensor spacing arrangement in the briquette 110 mm long is shown in Fig. 6. The distance between the subsequent sensor sets is 30 mm.

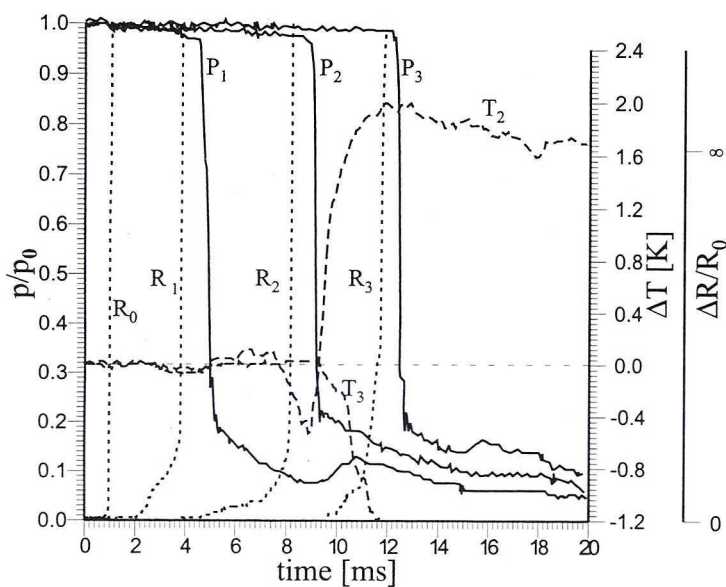

Fig. 7. Pressure, deformations and temperature — a briquette saturated with CO_2

Length of time for destruction and pressure wave passages and velocities of those waves

CO ₂					He			
distance from the briquette front [mm]	length of time of destruction wave passage [ms]	length of time of pressure wave passage [ms]	velocity of the destruction wave [m/s]	velocity of the pressure wave [m/s]	length of time of destruction wave passage [ms]	length of time of pressure wave passage [ms]	velocity of the destruction wave [m/s]	velocity of the pressure wave [m/s]
30	2.8	3.52	10.71	8.52	2.1	2.52	14.29	11.9
60	7.16	7.87	8.38	7.62	5.76	5.88	10.42	10.2
90	10.84	11.22	8.3	8.02	9.48	9.54	9.49	9.43

Thermocouples and coal strain gauges were fitted close to the briquette axis, while the pressure transducer was in its side surface.

The results of two tests are presented here. In the first test the coal was saturated with carbon dioxide, while in the other — with He. Saturating pressure in both cases was 0.7 MPa. During the first experiment the briquette was destroyed completely, while during the other tests there remained a fragment of untouched briquette about 10 mm long (an outburst ceased).

Fig. 7 presents the variations of pressure, deformations (the resistance being proportional to deformation) and temperature obtained in the tests during which the briquette was completely destroyed.

Table presents the lengths of time of destruction and pressure wave passage as well as briquette destruction rate and the velocity of pressure wave.

The beginning of the rapid pressure decrease lags behind briquette destruction, as registered by coal strain gauges, by about 0.8 ms. That might be explained by the fact that briquette destruction proceeds much faster inside its body than close to the walls. Fig. 8 presents the variations of gas pressure and their time derivatives. The farther from the briquette front, the higher the absolute value of the pressure derivative. This means that inclination of pressure drops increases. This may substantiate the assumption that a rarefaction shock wave is generated inside the briquette.

Temperature starts decreasing when the briquette decompresses rapidly, prior to its destruction (0.5 ms). Thermometers register temperature drops: T_2 by -0.6 K, T_3 by -1.2 K (unfortunately this one broke down, no further measurements are possible). Decrease of briquette temperature is caused by adiabatic decompression. The fact, that temperature drop registered by the thermometer T_3 is more significant is caused by more rapid briquette decompression there, (compare to the earlier remarks concerning the fast decrease of the pressure P_3). An increase of temperature T_2 takes place after the moment of briquette destruction, and may be due to friction effects.

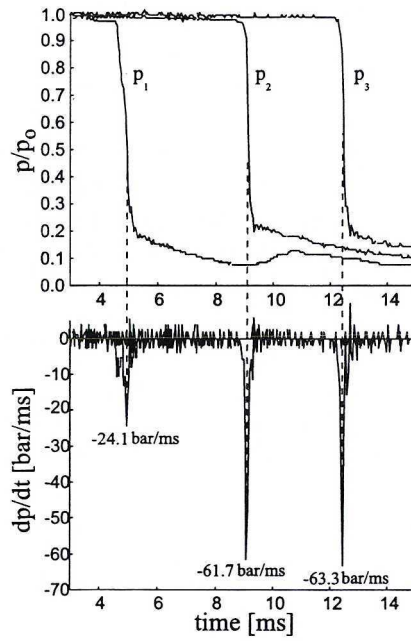

Fig. 8. Pressure and its derivatives

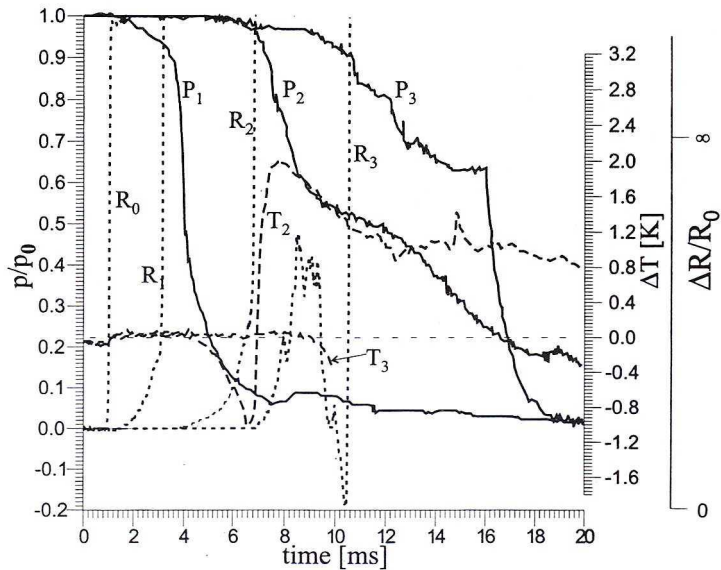

Fig. 9. Pressure, deformations and temperature — a briquette saturated with He

5. Briquettes saturated with He

Fig. 9 presents the variations of pressure, deformations and temperature obtained during the experiments using briquettes saturated with He. Deformation and pressure changes registered over the first two cross-sections are similar to those in the experiments with CO₂. However, the strain gauge in the cross-section 3 revealed quite a different signal. At first coal decompression proceeds as registered by other strain gauges, however, the briquette is not destroyed. For about 2 ms the briquette vibrates, being intermittently compressed and decompressed. Only afterwards the briquette is destroyed. Such behaviour can be largely explained by the fact that during this experiment there was no full briquette outburst. Table gives the time intervals after which subsequent briquette cross-sections were destroyed (as registered by coal strain gauges).

The fact that pressure drops registered by the transducers P_2 and P_3 are slower is caused by slowing down the outburst of briquette final parts. Such pressure variations do not suggest generation of rarefaction shock waves.

Temperature changes registered during this experiment were similar to those obtained when the briquette was saturated with CO₂.

6. Conclusion

As it was mentioned before, the experiments were aimed to verify the methods for measuring certain thermodynamic parameters (p , T , ε -deformation) during the process of the briquette destruction. Pressure measurements over the briquette side surface were already performed before (Bodziony et al., 1990), (Gawor et al., 1993). However, the effects of volume between the sensor membrane and briquette side surface were then neglected. Having this space filled with silicone grease allowed for more precise measurements of gas pressure in briquette pores.

An original result presented here is deformation measurement using coal strain gauges (Rysz, 1996). It reveals that a coal briquette decompresses before being destroyed.

The instant of briquette destruction registered by the coal strain gauge is different from that registered by the pressure transducer (a rapid pressure drop) which calls for special attention. It can be probably explained by the fact that briquette is destroyed more rapidly along its axis than close to the walls, because of the influence of friction. Therefore, the destruction wave is not flat.

In the course of the experiment during which the briquette was fully destroyed, inclination of the curves representing pressure drops increases with increase of the distance from the briquette front. That means that the destruction wave is not dispersed — on the contrary — a sharp wave front is formed. That may suggest the hypothesis that rarefaction shock waves are generated inside the briquette. Pressure changes registered in the course of the experiment in which the briquette was not fully destroyed are more complex. After an initial sharp drop, pressure decrease is

slowed down (P_2 and P_3). Some time later (about 18 ms) the pressure over the cross-section 2 may be higher than that registered in the cross-section 3. Such pressure inversion may be due to clogging of the expansion pipe with fragments of crushed coal. Unfortunately, there is no adequate information concerning the coal stream getting out of the expansion pipe.

Temperature measurements reveal that coal cools down while it decompresses. It is an adiabatic process. Temperature increase following briquette destruction seems to be caused by friction effects as coal fragments hit the thermocouples.

The paper has been supported by the Polish National Committee of Scientific Research (grant no. 9T 12A 029 08).

REFERENCES

- Bethe H. A., 1942. Theory of shock waves for an arbitrary equation of state. Office Scientific Research and Development, Washington, **57**, 545.
- Bodziony J., Nelicki A., Topolnicki J., 1990. Investigations of experimental generation of coal and gas outbursts. J. Litwiniszyn (Ed.), Strata as multiphase medium — Rock and gas outbursts. Kraków, Vol. II, 489–508 (in Polish).
- Czapliński A., Ceglarska-Stefańska G., 1990. Interrelation between sorption and dilatometric effects in hard coal. J. Litwiniszyn (Ed.), Strata as multiphase medium — Rock and gas outbursts. Kraków, Vol. II, 411–441 (in Polish).
- Ettinger I. L., 1990. Coal seam as solid solution of methane. Akademija Nauk SSSR Sibirskoe Otdielenie, Vsesojuznyj Naucznyj Zurnal Fiziko-Techniceskie Problemy Razrabotki Iskopaemych. **66**, 73.
- Gawor M., Meier G.E.A., Rysz J., 1993. Experimental research in the rarefaction waves within the mixture of crushed coal and gas. 20 Years Cooperation in Physics of Fluids IMG Göttingen—Kraków, 81–103.
- Gawor M., Kowalewski T., Rysz J., Smolarski A.Z., 1994. Experimental research on briquette destruction caused by rarefaction waves. Archives of Mining Sciences **39**, 3, 313–330.
- Lama R. D., Bodziony J., 1996. Outburst of gas, coal and rock in underground coal mines. Publisher: Lama Associates, Wollongong NSW, Australia.
- Litwiniszyn J., 1994. Rarefaction shock waves in porous media accumulating CO_2 , CH_4 , N_2 . Shock Waves **3**, 2, 223–232.
- Łydzba D., 1990. State of stress and effort in gas-coal strata in adjacent excavation. Wrocław Technical University. (Ph D Thesis) (in Polish).
- Moffat D. G., Weale K. E., 1955. Sorption by coal of methane at high pressure. Fuel **34**, 449–461.
- Rysz J., 1996. Strain gauges for rock outburst studies. MST News Poland. **4**.
- Smolarski A. Z., 1993. Mathematical model of the phenomena in the system of gas-coal. 20 Years Cooperation in Physics of Fluid. Göttingen—Kraków, 259–310.
- Ujihira M., Higuchi K., Nebeya H., 1985. Scale model studies and theoretical considerations on the mechanism of coal and gas outbursts. Proceedings of 21st International Conference of Safety in Mines Research Institutes Sydney, Australia, 21–25 October, 121–127.
- Thompson P. A., Lambrakis K. C., 1973. Negative shock waves. J. Fluid Mech. **60**, 187–208.
- Zeldovich, Y. B., Raizer Y. P., 1967. Physics of shock waves and high temperature hydrodynamic phenomena. Academic Press, London.

REVIEW BY: DOC. DR HAB. ZBIGNIEW WALENTA, WARSZAWA

Received: 10 March 2000.