

BARBARA KOZŁOWSKA *

APPLICATION OF THERMOGRAPHY METHOD TO THE INVESTIGATION OF TWO-DIMENSIONAL ELASTIC-PLASTIC STATES

In the paper, the author presents the application of thermography method for investigation of elastic-plastic states in two-dimensional models. The experimental testing was carried out on the duralumin elements with different stress concentrators loaded by uniformly distributed tensile stresses. The changes of temperature distribution on the surface of the models during loading process were recorded by a thermovision camera. On the basis of calibrating test carried out on the stretched element, the relationship between loading, temperature increment and specimen elongation was determined. Quantitative temperature distribution in chosen cross-sections of the models was determined using thermograms received for various levels of loading. On the basis of the obtained results, the author estimated the accuracy of the method as well as its usability for investigation of the plastic zones' localization and propagation.

1. Introduction

In recent years, partial plastifying of the material in constructional elements during exploitation has been more often accepted, and the analysis of elastic-plastic states has been more often provided. The considered elastic-plastic problems concern, among other things, determining the bearing capacity of elements (the load level at which one of their cross-sections becomes completely plastified, losing its usefulness as a part of the structure), the analysis of residual strain, or investigation on the adaptation process of elements subjected to repeated loading to the same load level.

In such cases, the experimental methods seem to be very useful. Numerical methods, widely applied nowadays, always contain some inaccuracy

* *Warsaw University of Technology, Faculty of Mechatronical Engineering, ul.Św. Andrzeja Boboli 8, 02-525 Warsaw, Poland, email: B.Kozłowska@mchtr.pw.edu.pl*

caused by real object modeling (especially concerned with non-linear problems) and still need a final experimental verification.

One of the experimental methods, which can be applied to elastic-plastic analysis, is the thermography method. It is the method which gives information about the deformation of the real object in the whole tested area (not only at several points), and can be used to investigate objects of complex shapes and loaded in different ways also in the over-elastic range of the material. Its advantage is also an excellent visualization of the progressing plastifying process, which allows direct observation of formation and development of plastic zones. It gives the possibility for a quick qualitative estimation of the effect of the element's shape and loading changes.

2. Thermography method

Thermography method means the technique of registration and visualisation of temperature distribution making use of infrared radiation (length of waves from $0.76 \mu\text{m}$ to $1 \mu\text{m}$) emitted by the surface of tested object.

All solids having temperature higher than absolute zero emit electromagnetic radiation, mostly infrared radiation. Special measuring instruments based on detection of this radiation can be used to obtain the object's temperature from some distance almost without delay and without changing the object's temperature. Typical thermographic set consists of a thermovision camera and a computer system for data processing and visualisation.

Thermography is a good method for investigating processes in which occur changes of temperature – e.g. the processes taking place during deformation of solids (e.g. metals).

Most of metals under loading deform firstly in elastic, and after that in plastic way. In both cases, the process of deformation is accompanied by temperature changes. The elastic deformation (connected with purely volumetric metal deformation) has a linear relationship between stress and temperature. During stretching process in this range, the increase of stress causes a decrease in temperature [4]. Plastic deformation connected with the microstructure evolution (dislocations mostly) is always accompanied by the increase of temperature (Fig. 1).

It has to be mentioned that the course of temperature change during tension process makes it possible to determine the offset yield strength, alternative in relation to another definitions. It corresponds to the stress value for which the curve describing temperature changes during tension process reaches minimum [2].

The changes of temperature of solids in the range of elastic deformation, associated with the change of their density, correspond to the behaviour of a

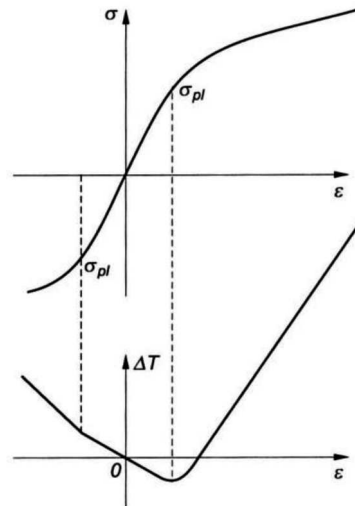

Fig. 1. Course of the temperature changes of solid body under tension and compression [4]

gas, in which cooling takes place at expansion, and heating at compression [3]. These changes are described by the equation:

$$\frac{\partial T}{\partial t} = \frac{T}{\rho \cdot c_V} \cdot \beta_{ij} \cdot \frac{\partial \varepsilon_{ij}}{\partial t} \quad (1)$$

where: β_{ij} – tensor of thermal linear expansion;

t – time;

T – absolute temperature of solid;

ρ – solid density;

c_V – specific heat at constant volume.

For an isotropic solid body being in plane state of stress, this equation can be reduced to the form:

$$\Delta T = -\frac{\alpha \cdot T}{c_\sigma} \cdot \Delta(\sigma_1 + \sigma_2) \quad (2)$$

where: c_σ – specific heat at constant stress;

α – coefficient of thermal linear expansion;

$\Delta(\sigma_1 + \sigma_2)$ – increment of the sum of the principal stresses.

In that case, the registration of temperature changes in two-dimensional object, loaded in the elastic range, allows determining the changes of the value of the sum of the principal stress components.

The lines of equal temperature change, obtained from the experiment, are the lines along which the sum of the principal stresses is constant:

$$(\sigma_1 + \sigma_2) = \text{const} \quad (3)$$

The method of thermography thus exhibits some similarity to the method of photoelastic coating, in which one obtains the information about the principal stresses difference.

The main difficulty in the thermography method is the separation of principal stresses.

In the photoelastic coating method, one can obtain a hyperbolic system of equations using equations of equilibrium for the plane state of stress (4) and experimental information. These can be solved by the analytical method of characteristics [16].

$$\begin{aligned}\frac{\partial\sigma_x}{\partial x} + \frac{\partial\tau_{xy}}{\partial y} &= 0 \\ \frac{\partial\sigma_y}{\partial y} + \frac{\partial\tau_{xy}}{\partial x} &= 0\end{aligned}\tag{4}$$

In thermography method, after introducing the experimental information into the equations of equilibrium (4), one obtains a system of equations of elliptic type, which cannot be solved in that way.

To separate the principal stresses, one can use additional information obtained from other experimental methods (such as photoelastic coating method [1, 12]). To determine the complete state of stress one may also apply hybrid (experimental and computer) methods, such as described in [15], where the authors propose a finite element type scheme for separating measured values of the sum of principal stresses.

The thermography method can be successfully used for studying various changes occurring in the material structure under loading, also in over-elastic range of the material. During plastic deformation, a significant part of the energy supplied to the body is converted into heat, causing an increase in its temperature related to the speed of deformation [10]. The application of the thermography method to the investigation of phase changes taking place in the material under increasing loading is shown in the paper [14] on the example of TiNi alloy (material with “memory”).

Observing the changes of temperature of the body surface in the over-elastic range of deformation, it is possible to investigate processes taking place in the material – the process of forming first plastic strain, its development and direction of propagation during increasing loading. It is also possible to estimate whether the material deforms uniformly (the homogeneity of deformation corresponds to the isothermal surface).

Attempts of application of the thermography method to the investigation of plastic zones can be found in the paper [5], where infrared radiation was used to measure temperature distribution in the analyzed area.

Measurements of temperature, based on the detection of infrared radiation, can also be used in mechanical testing in other cases: to detect the

formation and the evolution of microcracks in the material, to investigate residual stresses in welded joints [9], to determine the energy conversion during plastic deformation [11], etc.

However, it must be noted that during slow deformation of metals the emitted heat spreads quickly throughout the whole volume of the tested body, which can lead to underestimating of the actual temperature rise.

3. Experimental testing

3.1. Models of constructional elements

The investigation on elastic-plastic states by the thermography method was performed on stretched, two-dimensional models of constructional elements with different stress concentrators (holes) – Fig. 2.

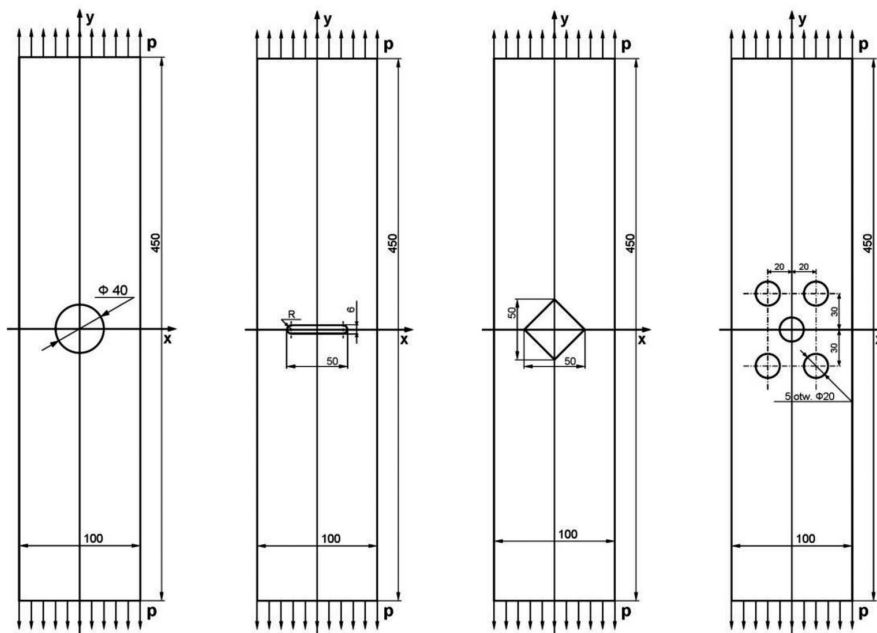

Fig. 2. Models of constructional elements

This type of elements and loadings occurs frequently in actual structural components such as: riveted truss joints, spot welds [17], different construction joints, particularly in the aerospace industry [13]. The areas of the elements weakened by the cut-outs made due to the technological or constructional needs are dangerous places in the structure, and they require special attention.

All the models were made of duralumin sheet (alloy EN-AW-2024) 3.0 mm thick. The material characteristic, shown in Fig. 3, was determined experimentally on the basis of standard static uniaxial tensile test (according to PN-EN 10002-1 for the test at ambient temperature) carried out on standard flat specimens made of the same material.

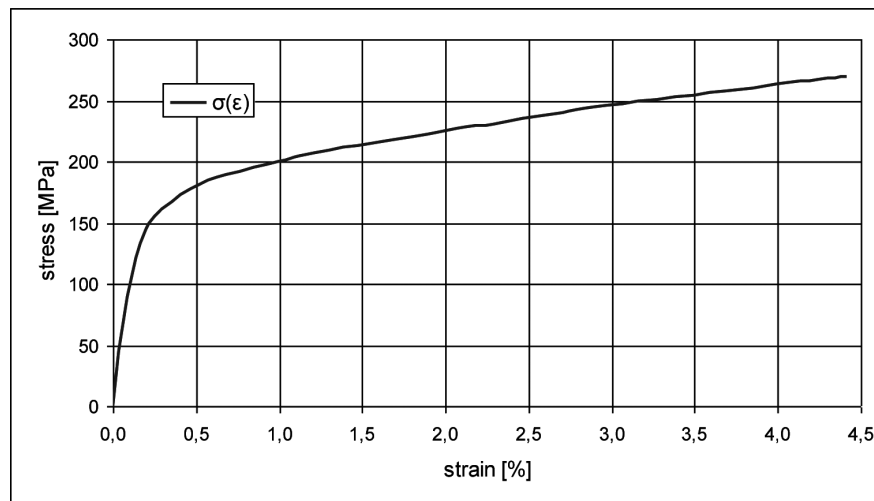

Fig. 3. Material characteristic

After the material tests, some bands of 100 mm width and a length of 450 mm were cut from the duralumin sheet. The length of the bands was assumed large enough to compensate potential non-uniformity of distribution of tensile stresses applied at their ends.

After mechanical working and surface preparation (grinding), different holes were cut in the models in the way which allowed avoiding the stresses arising as the result of machining. The shapes of these stress concentrators were designed on the basis of literature data and had the form of single central holes of various shapes and a group of five circular holes (Fig. 2). Finally, the models were covered with the layer of graphite.

The models were loaded at their ends with uniformly distributed tensile stresses (\mathbf{p}). As the measure of the loading intensity, the 'loading factor' (\mathbf{s}) was accepted. It was calculated as a ratio of the average tensile stresses at the cross-section weakened by the hole on the axis of symmetry perpendicular to the stretching direction in relation to the offset yield strength $\mathbf{R}_{0.2} = 182 \text{ MPa}$ (taken from the material characteristic).

The loading of the models was increasing continuously within the over-elastic range of the material, and the temperature changes on the specimen's surface were recorded by the thermovision camera ThermoCAMTM 675.

3.2. Calibrating test

To determine the relationship between loading, temperature increment and total specimen elongation, the calibrating test was carried out on the stretched strip made of the same material and of the same width as the analyzed models. For some levels of loading, the distribution of temperature increment (in relation to the temperature of the “cold” specimen – without loading) along the axis of symmetry x (perpendicular to the stretching direction) was determined on the basis of thermograms taken during the test.

The relationship between loading and total specimen elongation, obtained during the test, is shown in Fig. 4. On the diagram, there are marked levels of loading for which the temperature increment distribution was determined. The temperature increment distribution for chosen loading levels is shown in Fig. 5.

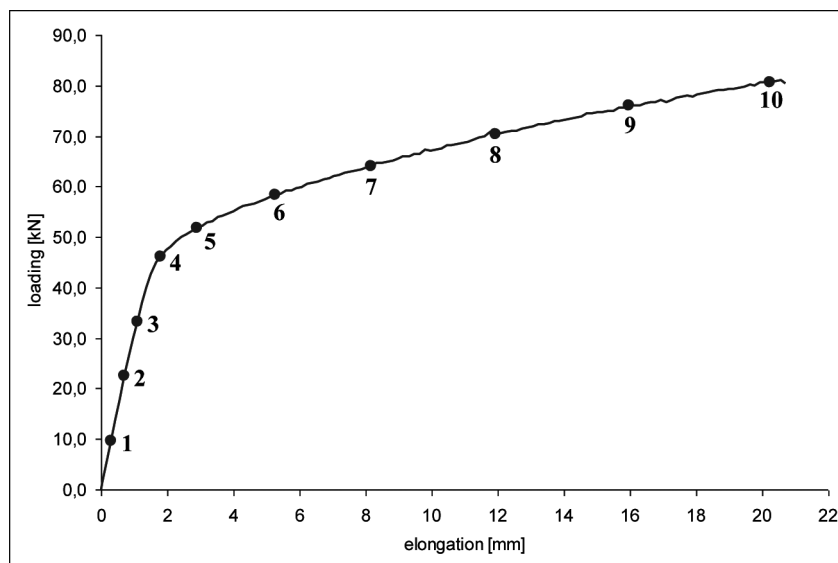

Fig. 4. Relationship between loading and total specimen elongation

The relationship between tensile stresses (p), temperature increment (ΔT) and total specimen elongation (L), determined on the basis of the calibrating test, is shown in Fig. 6.

On the diagram, the temperature drop during elastic deformation of the material (cooling of the specimen) is clearly visible. One can also see the difference between the point of temperature minimum on the diagram and the point corresponding to the offset yield strength taken from the material characteristic.

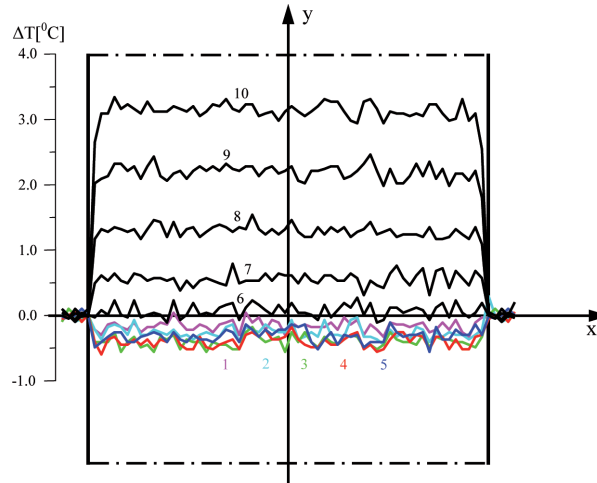

Fig. 5. Temperature increment distribution for chosen loading levels

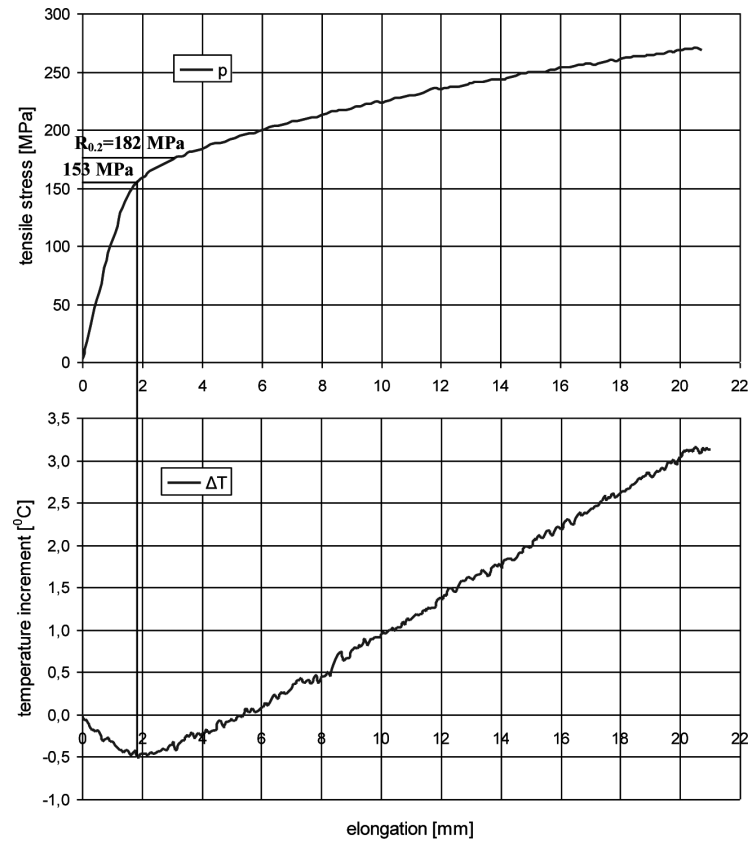

Fig. 6. Relationship between tensile stresses, temperature increment and total specimen elongation

This confirms the fact that in reality formation of the first plastic deformation (considering the value of stress corresponding to the temperature minimum) begins earlier than that indicated by the material characteristic (the offset yield strength). For the material of the tested models, the value of the offset yield strength resulting from the material characteristic is $R_{0.2} = 182 \text{ MPa}$, while that corresponding to the temperature minimum is 153 MPa , which is closer to the apparent elastic limit $R_{0.05}$ on the σ - ε relationship.

3.3. Elastic – plastic states investigation

The investigation on the initiation and propagation of the plastic zones around stress concentrators was performed on the models with central holes of different shape (**model I, II and III**) and on the model with five circular holes (**model IV**) (Fig. 2). The measurements were based on the thermograms taken at chosen loading levels.

In Fig. 7, the relationship between the loading and total elongation of the **model II** (with central slot) is shown. On the graph, there are marked loading levels (within the over-elastic range of material), for which the temperature increment distribution is determined along the axis of symmetry x (perpendicular to the stretching direction) (points 1, 2, and 3).

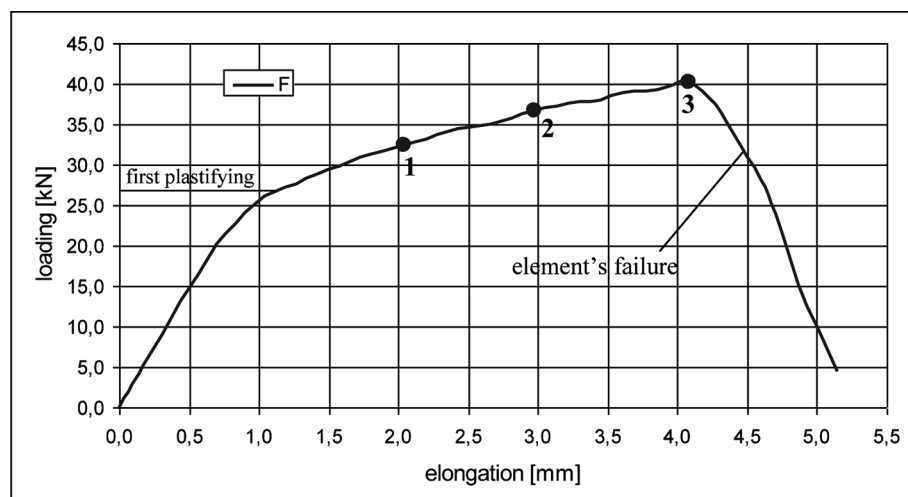

Fig. 7. Relationship between loading and total specimen elongation (model II)

The thermograms obtained for loading levels marked on the diagram (Fig. 7): $s = 1.172$ (the point 1), $s = 1.318$ (the point 2) and $s = 1.465$ (the point 3), are shown in Fig. 8. These levels of loading correspond to tensile stresses $p = 213 \text{ MPa}$, $p = 240 \text{ MPa}$, $p = 267 \text{ MPa}$, respectively.

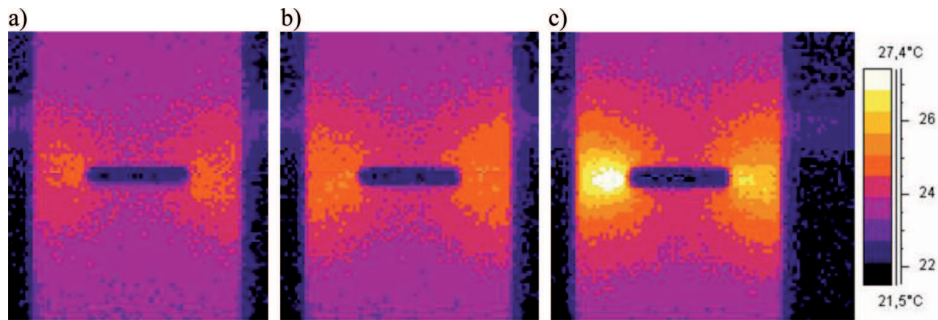

Fig. 8. Thermograms (model II) for loading levels: a) $s = 1.172$, b) $s = 1.318$, c) $s = 1.465$

The diagrams illustrating the distribution of temperature increment (in relation to temperature of “cold” specimen – 23.8°C) along the axis of symmetry x for the same levels of loading are shown in Fig. 9.

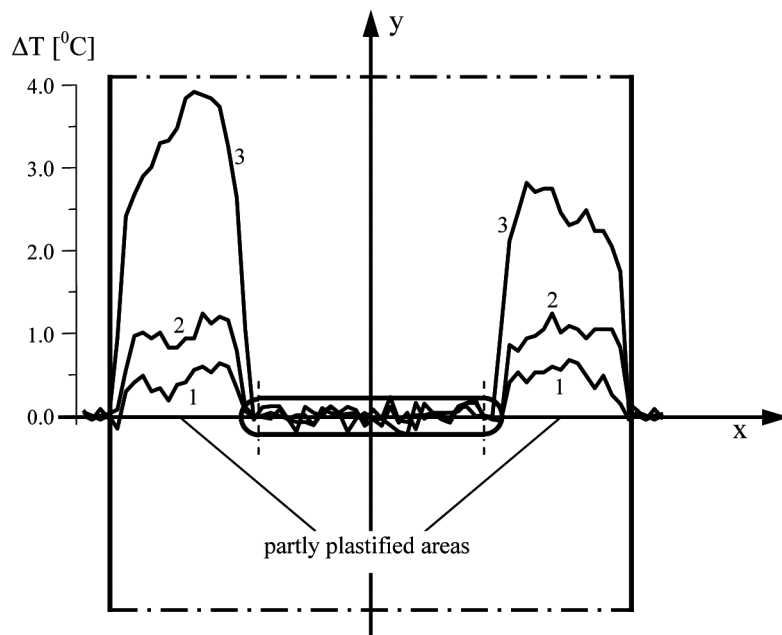

Fig. 9. Temperature increment distribution on x axis of symmetry (model II) for loading levels: $s = 1.172$ (1), $s = 1.318$ (2) and $s = 1.465$ (3)

On the basis of these diagrams is not possible to perform a quantitative analysis of strain. The diagrams show clearly, however, the increasing degree of the material plastifying during the growth of loading.

In the case of the model II, one can notice non-symmetry in evolution of plastic zones on the both sides of the hole. This is clearly visible on the presented thermograms (Fig. 8). This effect is probably caused by the material heterogeneity – the lack of symmetry appears at some loading level

and it can be observed as faster development of plastic zones once at the one side of the hole, once at the other. The non-symmetry of the plastic zones expansion is also confirmed by the graphs of temperature increment distribution (Fig. 9), especially at higher loading levels.

The relationship between the loading and total elongation for **model IV** (with five circular holes) is shown in Fig. 10. On the graph, there are marked loading levels (within the over-elastic range of material), for which the temperature increment distribution is determined in chosen model's cross-sections (points 1, 2 and 3).

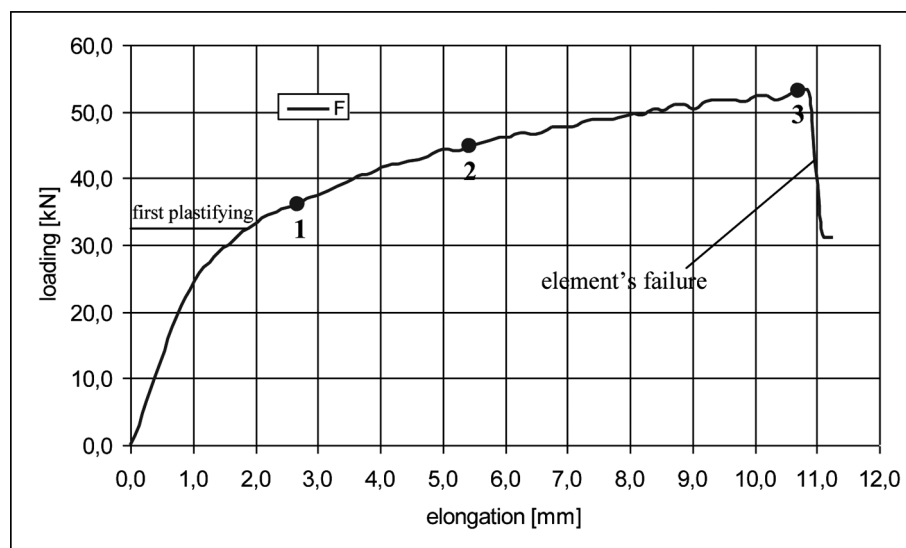

Fig. 10. Relationship between loading and total specimen elongation (model IV)

The thermograms for the loading levels marked on the diagram (Fig. 10): $s = 0.824$ (the point 1), $s = 1.007$ (the point 2) and $s = 1.191$ (the point 3), are shown in Fig. 11. These levels of loading correspond to tensile stresses $p = 150$ MPa, $p = 183$ MPa, $p = 217$ MPa, respectively.

These thermograms show clearly expansion of plastic zones, up to full plastifying of one of the weakened cross-sections, which occurs at the loading level causing the change in the model's geometry.

The diagrams illustrating the distribution of temperature increment (in relation to the temperature of "cold" specimen – 24.0°C) along the axis of symmetry x for these levels of loading are shown in Fig. 12.

For the same loading levels, there was also determined the distribution of temperature increment in the model's cross-section passing through the centres of the two upper holes. The diagrams illustrating this distribution are shown in Fig. 13.

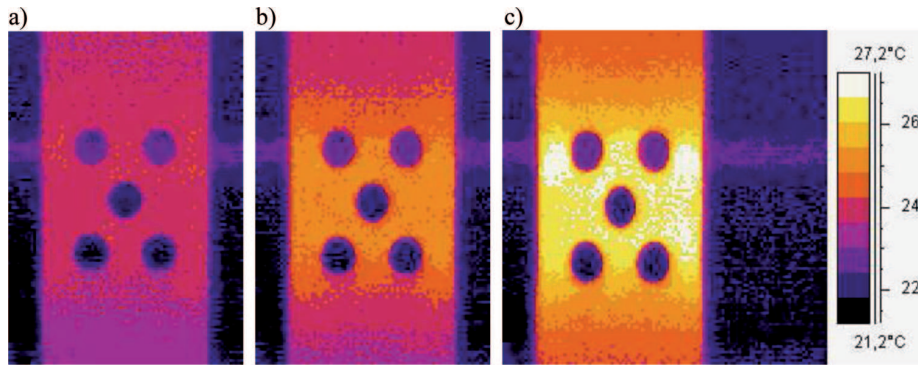

Fig. 11. Thermograms (model IV) for loading levels: a) $s = 0.824$, b) $s = 1.007$, c) $s = 1.191$

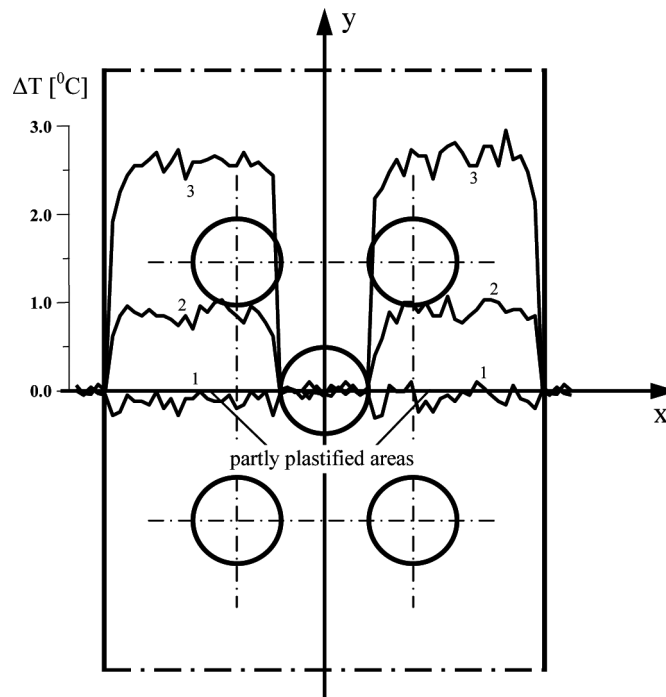

Fig. 12. Temperature increment distribution on x axis of symmetry (model IV) for loading levels: $s = 0.824$ (1), $s = 1.007$ (2), $s = 1.191$ (3)

As it is shown by the thermograms and the diagrams of temperature increment distribution, in the model with a larger number of holes the mechanism of plastic zones evolution is more complicated. It is difficult to predict a priori which of the weakened cross-section would be fully plastified first.

This observation is confirmed by investigations carried out by other experimental methods (photoelastic coating method and the moiré method –

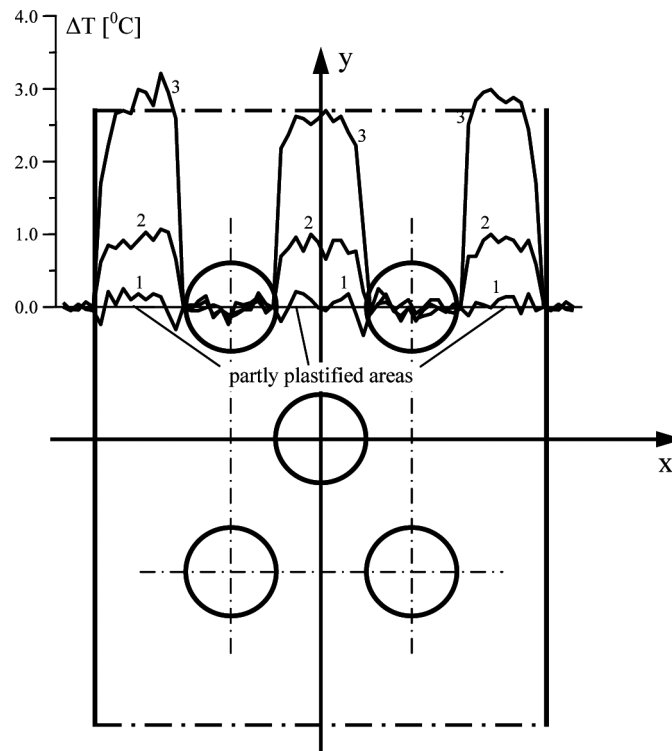

Fig. 13. Temperature increment distribution on the axis passing through centers of two upper holes (model IV) for loading levels: $s = 0.824$ (1), $s = 1.007$ (2), $s = 1.191$ (3)

[6, 7, 8]), although only the method of thermography makes it possible to observe this process up to the failure of the element.

Due to low resolution of the thermal images obtained from the infrared camera, the information about the temperature distribution on the surface of tested models is not sufficient for quantitative determination of strain values in chosen cross-sections of the specimens. However, the accuracy of temperature increment measurement by infrared camera depends mainly on its sensitivity, which increases owing to the development of electronic technology.

Even if the thermograms give rather qualitative than quantitative information about deformation of elements, they show full evolution of plastic zones, from the beginning of their creation to the destruction of the material (Fig. 14, 15).

Besides, in the thermography method there is no limitation associated with the propriety of the layer covering the model (graphite), contrary to what is met in the photoelastic coating method (the photoelastic layer), or even in the moiré method, when the grid is coated on the surface of the model.

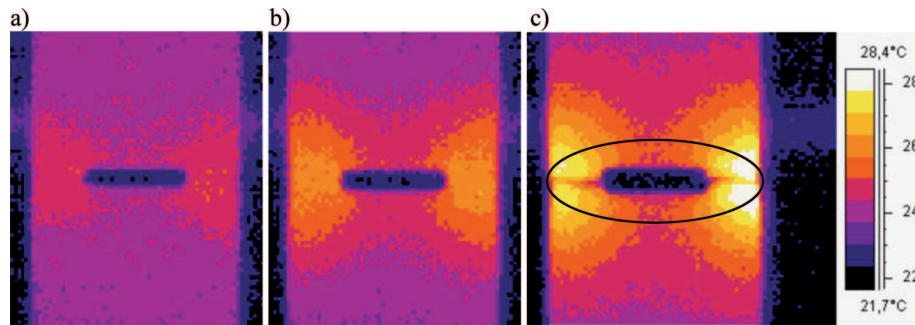

Fig. 14. Thermograms (model II) for loading levels: a) $s = 1.026$, b) $s = 1.355$, c) $s > 1.465$ (element's failure)

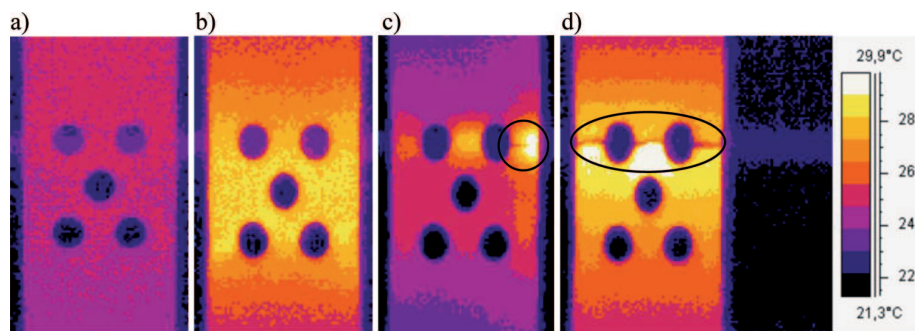

Fig. 15. Thermograms (model IV) for loading levels: a) $s = 0.801$, b) $s = 1.053$, c) $s = 1.202$ (first crack at upper right hole), d) $s > 1.213$ (element's failure)

4. Conclusions

The process of formation and development of plastic zones may have various forms, depending on the geometry of the constructional elements, the shape of stress concentrators that weaken cross-sections of the elements, and the way of loading. For that reason, considering safety of the whole structure, it is very important for the designer to acquire the knowledge about the localization of the first plastic deformation and their propagation during exploitation.

On the basis of the relationship $\Delta T - p - L$ (Fig. 6), determined from the calibrating test, there was verified that the first plastic deformation in the material of the tested models (aluminium alloy) appears earlier (the value of stress corresponding to the temperature minimum – 153 MPa), than it is indicated by the material characteristic (offset yield strength – 182 MPa).

The thermograms obtained for several levels of increasing loading for the models with stress concentrators illustrate the process of formation and development of plastic zones, the changes in their boundaries and the direction of propagation.

However, the diagrams of temperature increment distribution in chosen cross-sections of the models, determined using these thermograms, do not have sufficient resolution for a quantitative strain analysis.

The level of accuracy of thermography method makes it possible to get a general view of plastic deformation distribution rather than quantitatively determine strain and stress state in chosen sections (considering the difficulties with stress components separating on the basis of temperature distribution only). It should be noted, however, that plastic zones can be found and their average level can be estimated much easier and quicker using thermography than by other experimental methods. Besides, the possibility of direct observation of the process of expansion of plastic zones allows us to find all kinds of anomalies in their formation, non-homogeneity of the material and the local defects.

Thus, the thermography method can be used as a preliminary tool that makes it possible to select an area in the element to be tested with more accurate methods (areas of plastic zones formation). On the other hand, this method allows for observation of the mechanism of plastic material failure in the range which is inaccessible for other experimental methods.

Manuscript received by Editorial Board, May 14, 2012;
final version, August 24, 2012.

REFERENCES

- [1] Barone S., Patterson E.A.: *Full-field Separation of Principal Stresses by Combined Thermo- and Photoelasticity*. Experimental Mechanics 36(4), 1996, 318-324.
- [2] Blanc R.H., Giacometti E.: *Infrared stroboscopy – a method for the study of thermomechanical behaviour of materials and structures at high rates of strain*. Int. Journal Solids Structures, vol. 17, 1981, 531-540.
- [3] Fung Y.C.: *Foundations of Solid Mechanics*. Prentice-Hall, 1965, polskie tłumaczenie, PWN, 1969.
- [4] Gadaj S.P., Nowacki W.K., Pieczyska E.A.: *Investigation of temperature distribution during plastic deformation of stainless steel*. Proc. of Eurotherm Seminar QIRT'96, Stuttgart, September 1996.
- [5] Handzel-Powierża Z., Choroś J.: *Próba zastosowania termowizji do badania strefy plastycznej na wierzchołku karbu*. Mat. VIII Sympozjum Doświadczalnych Badań w Mechanice Ciała Stałego, Warszawa 1978, część 1, 300-308.
- [6] Kozłowska B.: *Strain and stress analysis in two-dimensional elastic-plastic state by moiré method*. Transactions of FAMENA XXXII (1), 2008, 19-26.
- [7] Kozłowska B.: *The investigation of elastic-plastic states by photoelastic coating method*. Proc. of 25th DANUBIA-ADRIA Symposium on Advances in Experimental Mechanics, České Budějovice 2008, 129-130.
- [8] Kozłowska B.: *Doświadczalna analiza plastycznego zniszczenia elementów konstrukcji*. Prace Naukowe Politechniki Radomskiej – Transport 3(23) 2005, 283-288.
- [9] Oda I., Doi T., Sakamoto H., Yamamoto M.: *Inference of plastic deformation in welding residual stress field from infrared thermography*. Recent Advances in Experimental Mechanics

- proc. of the 10th International Conference on Experimental Mechanics, Lisbon, 1994, 817-822.
- [10] Oliferuk W.: *Application of infrared radiation detection to the metal behaviour investigation under mechanical loading*. Journal of Theoretical and Applied Mechanics, Vol. 34, No. 2, 1996, 439-458.
- [11] Oliferuk W.: *Proces magazynowania energii i jego strukturalny aspekt podczas jednoosiowego rozciągania stali austenicznej*. Prace IPPT/11, Warszawa 1997.
- [12] Pasiński J., Pyrzanowski P., Stupnicki J.: *Elastoptyka i termowizja – mariaż dający nowe możliwości rozdzielenia składowych tensora naprężenia*. Mat. XVI Sympozjum Mechaniki Eksperymentalnej Ciała Stałego, Jachranka 1994, 288-291.
- [13] Pastrama S.D., Iliescu N., Atanasiu C.: *Photoelastic analysis for overdeterministic calculation of the stress intensity factor*. Proc. of 22nd DANUBIA-ADRIA Symposium on Advances in Experimental Mechanics, Parma 2005, 45-46.
- [14] Pieczyńska E.A., Gadaj S.P., Nowacki W.K., Tobushi H.: *Phase-Transformation Fronts Evolution for Stress- and Strain-Controlled Tension Tests in TiNi Shape Memory Alloy*. Experimental Mechanics, Vol. 46, No. 4, 2006, 531-542.
- [15] Rauch B.J., Rowlands R.E.: *Stress Separation of Thermoelastically Measured Isopachics*. Experimental Mechanics 41(4), 2001, 358-367.
- [16] Szczepiński W.: *Method of characteristic in computation of the experimental stress analysis*. Bull. de l' Acad. Polonaise des Sc. XII(112), 1964.
- [17] Wung P., Walsh T., Ourchane A., Stewart W., Jie M.: *Failure of Spot Welds under in-plane Static Loading*. Experimental Mechanics 41(1), 2001, 100-106.

Zastosowanie metody termografii do badania płaskich stanów sprężysto-plastycznych

Streszczenie

W pracy przedstawione zostały wyniki badań przeprowadzonych metodą termograficzną na płaskich modelach elementów konstrukcyjnych osłabionych koncentratorami naprężeń (otworami) o różnych kształtach. Modele, wykonane z duraluminium, zostały obciążone równomiernie rozłożonymi na końcach naprężeniami rozciągającymi wywołującymi częściowe uplastycznienie materiału. Zmiany rozkładu temperatury na powierzchni modeli podczas procesu obciążania rejestrowane były w sposób ciągły przy pomocy kamery termowizyjnej. Na podstawie badań wstępnych, przeprowadzonych na rozciągającym elemencie bez otworów o szerokości takiej, jak badane modele, zostały sporządzone zależności między wydłużeniem modelu a jego obciążeniem i przyrostem temperatury. Do opracowania ilościowego rozkładu temperatury w wybranych przekrojach modeli wykorzystano termogramy odpowiadające określonym poziomom obciążenia w zakresie sprężysto-plastycznym. Na podstawie otrzymanych wyników oszacowano dokładność stosowanej metody i jej przydatność do badania lokalizacji i rozprzestrzeniania się stref plastycznych.