

ARCHIVES
of
FOUNDRY ENGINEERING



ISSN (2299-2944)
Volume 12
Issue 2/2012

DOI: 10.2478/v10266-012-0069-y

Published quarterly as the organ of the Foundry Commission of the Polish Academy of Sciences

251 – 260

Structure of Water Mist Stream and its Impact on Cooling Efficiency of Casting Die

R. Władysiak^{a*}, P. Budzyński^b

^aDepartment of Materials Engineering and Production Systems, Technical University of Lodz
1/15 Stefanowskiego Street 90-924 Lodz, Poland

^bDepartment of Chemical Engineering, Politechnika Łódzka, 213 Wólczajska Street, 90-924 Lodz, Poland

*Corresponding author. E-mail address: ryszard.wladysiak@p.lodz.pl

Received 25-05-2012; accepted in revised form 31-05-2012

Abstract

The work is a continuation of research on the use water mist cooling in order to increase efficiency of die-casting aluminum alloys. The paper presents results of research and analysis process, spraying water and generated a stream of water mist, the effect of the type of nozzle, the nozzle size and shape of the emitting of the water mist on the wall surface of casting die on the microstructure and geometry of water mist stream and cooling efficiency. Tests were used to perform high-speed camera to record video in the visible and infrared camera. Results were used to develop a computerized image analysis and statistical analysis. The study showed that there are statistical relationships between water and air flow and geometry of the nozzle and nozzle emitting a stream of microstructure parameters of water mist and heat the incoming stream. These relationships are described mathematical models that allow you to control the generating of adequate stream of water mist and a further consequence, the cooling efficiency of casting die.

Keywords: Innovative Foundry Technologies and Materials, Casting Die Cooling, Water Mist, Microstructure, Heat Flux

1. Introduction

The ongoing work is a part of studies on the application of water mist system for multiple sequential cooling of casting die to produce silumin castings [1-7]. Currently, the industry uses two methods of cooling permanent molds - the first consisting of the heat received by compressed air, which is very energy intensive due to the low efficiency of heat transfer through the air and cooling the water. The essence of the research is the efficient cooling mist of water through evaporation of water droplets on a hot surface of the chill. An analysis of the literature and preliminary studies indicate that the efficiency of removing heat from the wall by the stream of chill fog is largely determined by the characteristics of the generated stream flow resulting from the amount of air and water in the mist of water, spray water and the shape and size of the emitting fog nozzles used water-cooled wall of the casting die.

The aim of this study was to investigate the effect of water spraying conditions and parameters of water and air flow on the geometry and microstructure of the stream and also the effect of size and shape of the nozzle emitting water mist on cooling efficiency of casting die.

2. Experimental

The research was conducted at the position shown in Figure 1 Water mist produced in the unit (8) as a result of dispensing selected amounts of water flow and compressed air. Water spray was used is shown schematically in Figure 2 sprays: eddy and jet, which generate water droplets in the compressed-air channel transporting water mist to jet-emitting it to the cooled surface of the chill. It was examined use of the cooling emitting nozzles with circular and rectangular cross-sectional area sizes ranging from

$24 \div 133 \cdot 10^{-6} \text{ m}^2$. Investigations of effectiveness of spraying water and generating of the mist and also cooling efficiency of casting die realized for parameters range $150 \div 600 \text{ l/min}$ of air and $0.07 \div 0.6 \text{ l/min}$ of water.

Studies of microstructure, geometry and kinetics of the stream of droplets was carried out using high-speed camera company Fastec Imaging, camera and computer systems NIS-Elements, Nikon and Corel Draw Graphics Suite X5 for the analysis of images.

The study of effectiveness of the heat receiving by water mist stream was performed using the test casting die (2) which made of steel. It was heated electrically with the measurement of energy consumption.

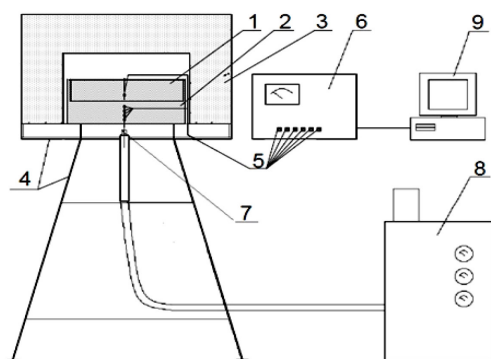

Fig. 1. Schema of research station: 1 – cast, 2 – casting die, 3 – shield thermal insulation, 4 – tripod, 5 – thermocouples, 6 – temperature recorder, 7 – cooling nozzle, 8 – water mist generator, 9 – PC

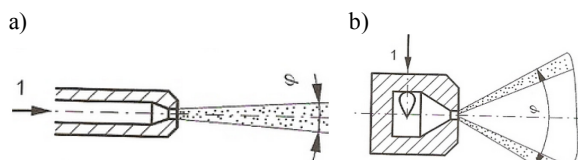

Fig. 2. Spray diagram: a) stream nozzle, b) swirl jet, 1 – liquid, ϕ – spray angle [8]

Casting die were placed in a heat-insulating sheath (3) in such a way that the heat exchange takes place only by the bottom surface of the circular, which is cooled by emitting water mist nozzle, perpendicular to the surface of the casting die. The temperature inside the die was examined using the displaced in the cold wall type K thermocouples and infrared camera used optiris PI's.

Statistical analysis of test results and mathematical models were developed using the Statgraphics computer system.

Figure 3 presents the methodology for determining the measuring area to study the geometry and microstructure of water mist stream.

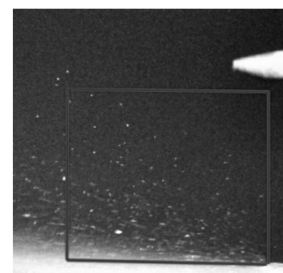
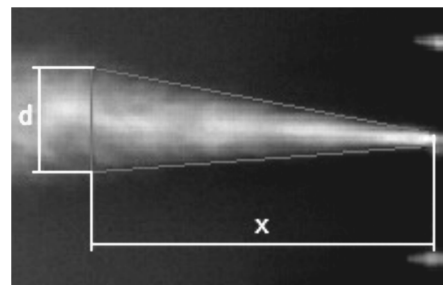

Fig. 3. Determination of the analyzed area measuring the emitted of water mist stream

3. Results

The effect of flow velocity stream of water mist was investigated with the size of the angle, cross-sectional surface area of the nozzle and the amount of water and air on the effectiveness of the incoming heat flux from the hot surface of the casting die. The effect of water and air flow was studied in the range $120 \div 600 \text{ l/min}$ of air and $0.07 \div 0.6 \text{ l/min}$ of water.

3.1. Disintegration of water stream

Figures 4-6 are examples of results of the process of generating droplets using spray jet (Fig. 4) with a 1mm bore diameter and flow rate 0.6 l/min , and swirl jet (Fig. 5 and 6) with a flow of 0.03 l/min (Fig. 5) and 0.6 l/min (Fig. 6). The study shows that jet nebulizers are small size and simple construction, and the nature of the degradation of stream depends largely on the speed of water flow. The figure shows that at low flow of water generated stream is uniform and compact at a distance from the nozzle to about 40 mm, while the distance increases further stream is sprayed. Figure 4 shows the stream of liquid flowing from the spray jet of water flow 0.6 l/min . It can extract the following three zones: I - a continuous stream, II - disintegration (transient, the presence of jets and droplets), III-zone drops.

Increased pressure and the same amount of water flow stream causes earlier disintegration (reduction of zones I and II), which is closer to the nozzle. Observed in the case of spray droplet stream formation process due to asymmetric waves occur at speeds of liquid outflow from the nozzle above 1 m/s and decay under the influence of the aerodynamic flow at a speed of about 100 m/s .

Figure 5 shows the image recording process of spraying water with use designed swirl jet.

In the process we can extract the initial phase - generating membrane of the water, a transitional stage - disintegration of the membrane to the stream due to wave and perforation of the membrane and the disintegration phase of the water jets into droplets.

Research shows that the disintegration of liquid jets are similar for the three zones as stream generated from the spray jet. A comparison of the results of spray jet and vortex shows that the

zone of continuous membrane resulting from the spray vortex is much shorter and required to initiate degradation of stream flow and water pressure are significantly lower at the same time a much larger diameter holes than for the spray nozzle jet. In addition, the study of spray angle (Fig. 2) shows that the use of spray jet to control the values of spray angle of the spray stream of droplets in the range of $51 \div 76^\circ$.

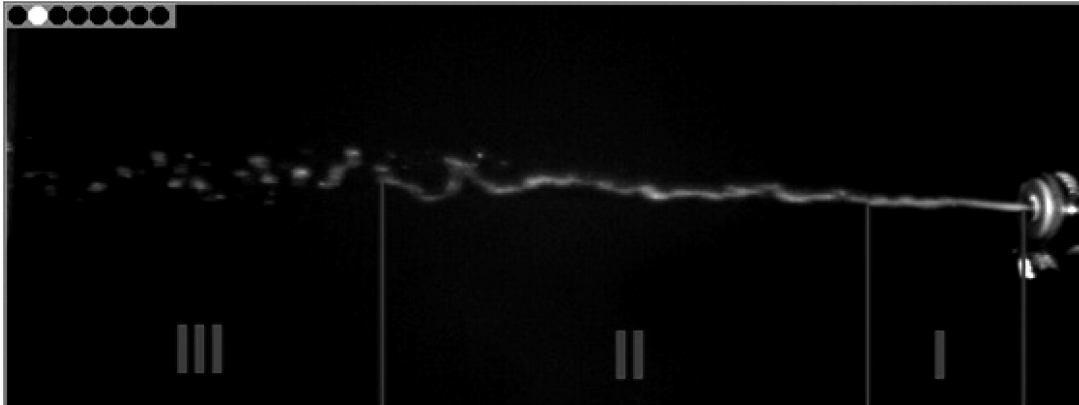

Fig. 4. Generating of droplets by the jet spray with use of water flow 0.6 l/min



Fig. 5. Generating droplets by the swirl jet, with use of water flow 0.03 l/min and water pressure 0.01



Fig. 6. Generating of droplets by the swirl jet with use of water flow 0.6 l/min and pressure of 0.45 MPa

3.2. Microstructure of water mist stream

Figure 7 shows exemplary results of image analysis efficiency of spraying water by swirl sprayer for water flow 0.08 l/min. The histogram shows that the generated droplets have a width range of

equivalent diameter from 1.6 microns to over 194.6 μm . The largest drops were registered in the diameter range from $10 \div 20$ microns. Moreover, most of the population is a drop of up to 40 microns. The median of a equivalent diameter of droplet for the spraying conditions is 17 μm .

Figure 8 shows a comparison of the median of equivalent diameter of water drops obtained as a result of swirl jet spraying water with droplets emitted from occurring in the cylindrical nozzle, the final stream of water mist. Research shows that the use of transporting air stream flow of 100÷160 l/min does not change the diameter of the parent generated by spray water droplets. Increasing the air flow to 200 l/min reduces the water droplets. Their median of equivalent diameter decreases from 15µm to 6 microns. Moreover, the increase of water flow increases the size of droplets generated by spray as well as in stream water mist. Another parameter set of recorded images was the average distance between the water droplets in the mist. This parameter describes the concentration of droplets in a stream of water mist. Figure 9 shows the histogram for the sample distribution of the average distance between drops. Research shows that the most common distance is included in the range 1.5÷2.5 mm.

Based on an analysis of changes in time, a fast-speed camera recorded the instantaneous position of the drops of water in the stream water mist specified average traffic speed drops. Figure 10 shows the comparison of median droplet velocity depending on air flow (150÷220 l/min) and water 0.25÷0.63 l/min during the generation of water mist. Research shows that the average droplet velocity increases with increasing air flow while generating water mist.

Based on recorded research results compiled in Table 1, the mathematical models equivalent diameter drops, the average speed drops and the concentration of droplets in the generated stream of water mist as a function of air flow (P_p) and water (P_w), the equivalent diameter of the spray droplet (D_{kr}) and the equivalent diameter in the mist of water droplets (D_{km}).

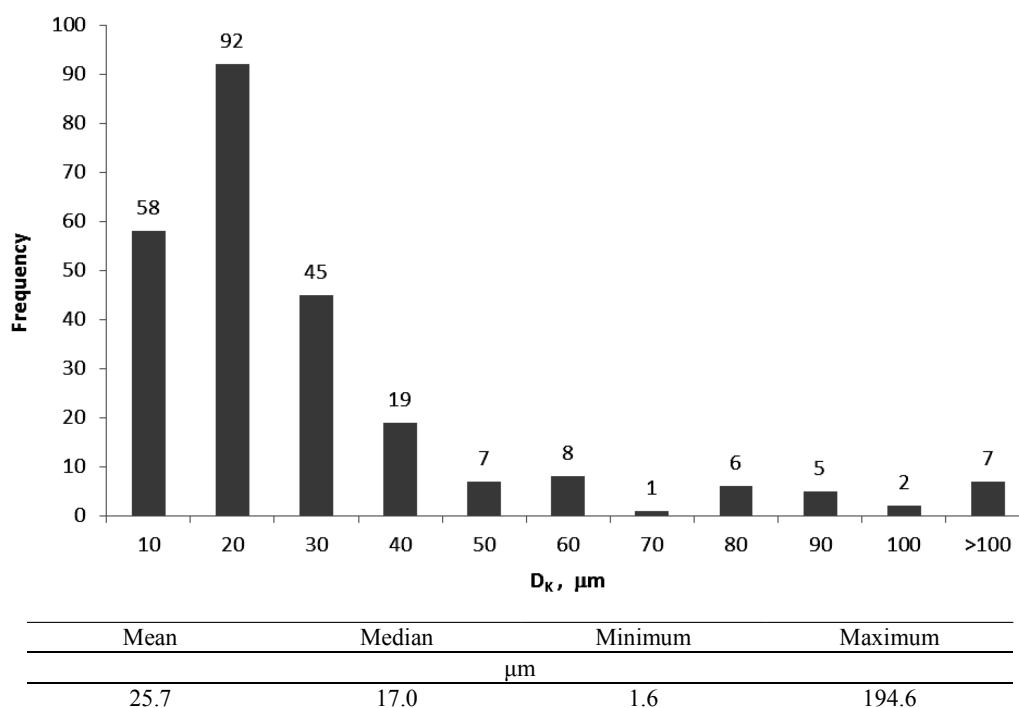

Fig. 7. Histogram and statistical parameters of droplet diameter distribution obtained from the swirl nozzle for flow rate 0.08 l/min

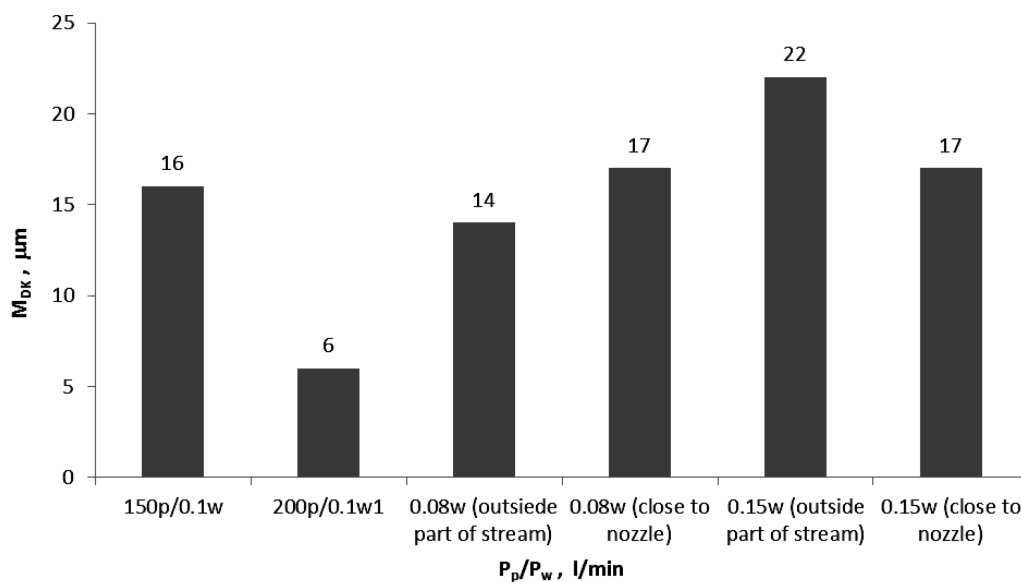
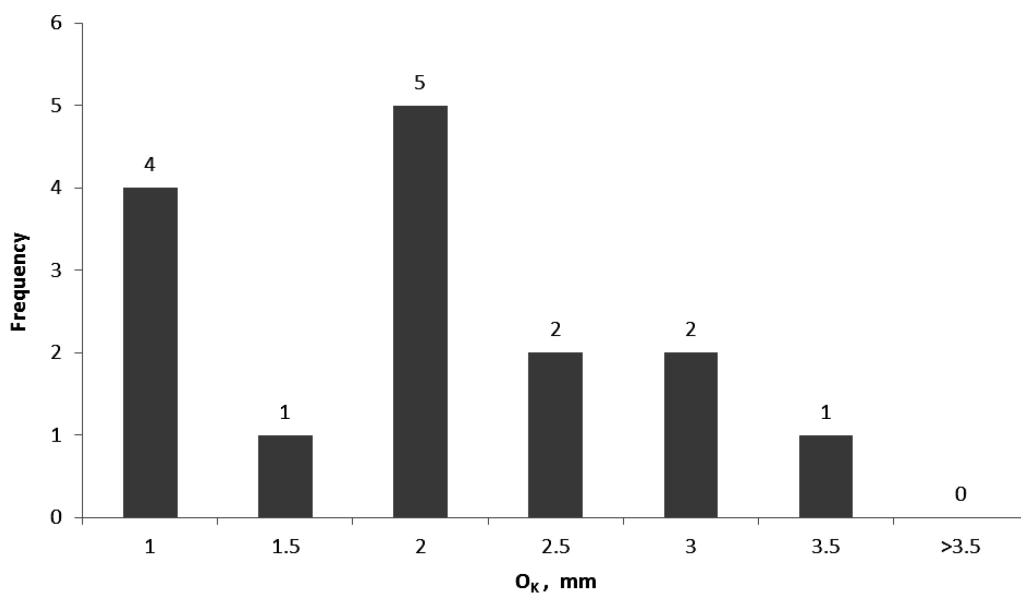

Fig. 8. The median diameter of the droplet, depending on the parameters of water and air flow generated in the water mist with use the swirl jet



Mean	Median	Minimum	Maximum
mm			
1.74	1.76	0.54	3.10

Fig. 9. Histogram of the distance between the water mist droplets for air flow 150 l/min, and water 0.1 l/min

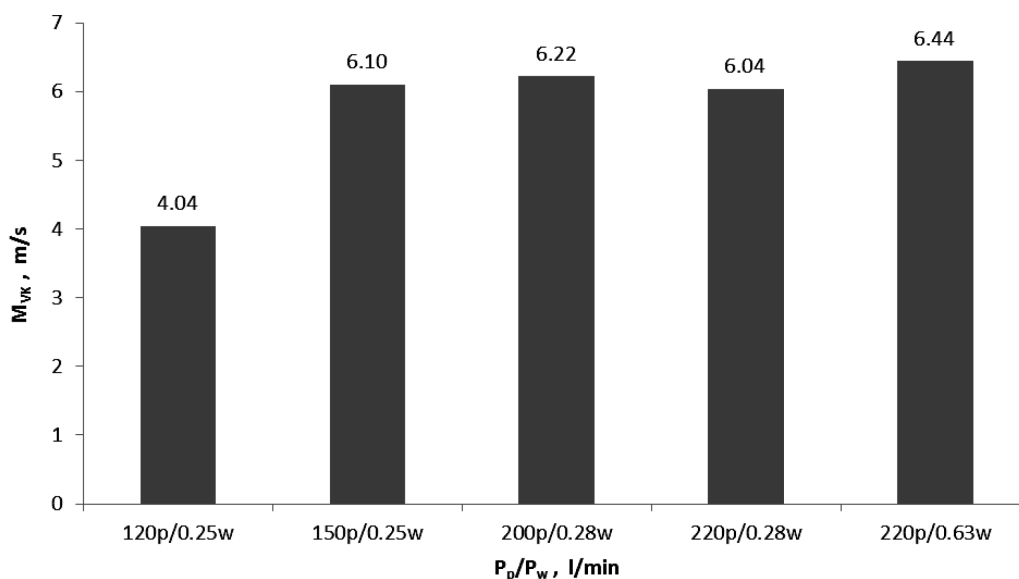

Fig. 10. The median average speed drops depending on the parameters of water and air flow in the water mist

Table 1.

Mathematical models developed according to equivalent diameter of droplet, the average speed drops and the distance between the drops

Model D_K	Test-F	R^2 (adj)	Standard error	P-value
	29.79	0.93	0.1151	0.0031
$D_K = 65.8041 - 0.0610603 * P_p - 1673.59 * P_p^{-1} - 3.42988 * D_{kr} + 0.0967842 * D_{kr}^2$, μm				
Model V_K	Test-F	R^2 (adj)	Standard error	P-value
	75158.89	0.99	0.00399783	0.001
$V_K = -13.7993 + 0.0168473 * P_p + 1.83261 * P_w + 0.680209 * D_{km} + 0.339042 * D_{kr}$, m/s				
Model O_K	Test-F	R^2 (adj)	Błąd standardowy	P-value
	1266.58	0.99	Standard error	0.001
$O_k = -6.34028 - 4.28818 * P_w + 0.066565 * P_p$, mm				

3.3. Influence of shape and size emitting nozzle on geometry of water mist stream and cooling efficiency

The effect of nozzle of diameter from 6mm to 13 mm, adequately cross-sectional area of 28 mm² to 132 mm² and a nozzle with rectangular cross section with dimensions of the sides of the from 3x8 mm to 6x15 mm and a cross-sectional area ranging from 24 mm² to 92 mm² was investigated in the work.

Figures 11 and 12 show representative test results of impact of the circular nozzle cross-sectional area and the effect of air velocity conveying the water mist on the change spray angle φ . Research shows that the spray angle increases ranging from 12.9÷14.3° with increasing cross-sectional nozzle emitting water mist and reduce with increasing the air velocity (air flow) transporting the water droplets from the swirl jet to the emitting nozzle water mist on the cooled surface of the casting die. A similar dependence exists for rectangular nozzles.

In Figures 13 and 14 show the effect of the nozzle cross-sectional area (P_d) on the appropriate amount of incoming heat flux (Sc) from cooled casting die and the temperature field of 66.5÷86.5°C, of cooled surface die. Research shows that an increase in cross-sectional area as a circular orifice and a rectangular flow increases the heat received from the cooled casting die. A comparison of the effectiveness of cooling by means of chill mist emitted from a circular nozzle with a nozzle with rectangular cross section shows that in the range up to about 40 mm² both types of nozzle receive similar amount of heat flux. Along with an increase in cross-section of the nozzle cooling efficiency through a rectangular nozzle is larger than the circular nozzle.

Table 2 shows the binary images cooled casting die surface obtained by computer analysis of thermal images recorded during die cooling with water mist emitted from the nozzle types tested an adjustable flow of water and air. As a result of image analysis identified the areas casting die surface temperature field with average values in the range 66.5÷86.5°C. This temperature range

is representative of the incoming heat flux throughout the range of variation of the flow of air and water while generating water mist using spray designed swirl jet. Based on the recorded results of the regression analysis method developed presented in Table 3,

according to a mathematical model of heat flux from the characteristic parameters of the cooling process chill, the air flow (P_p) and water (P_w), the nozzle cross-sectional area (P_d) and field-cooled wall surface temperatures casting die (area).

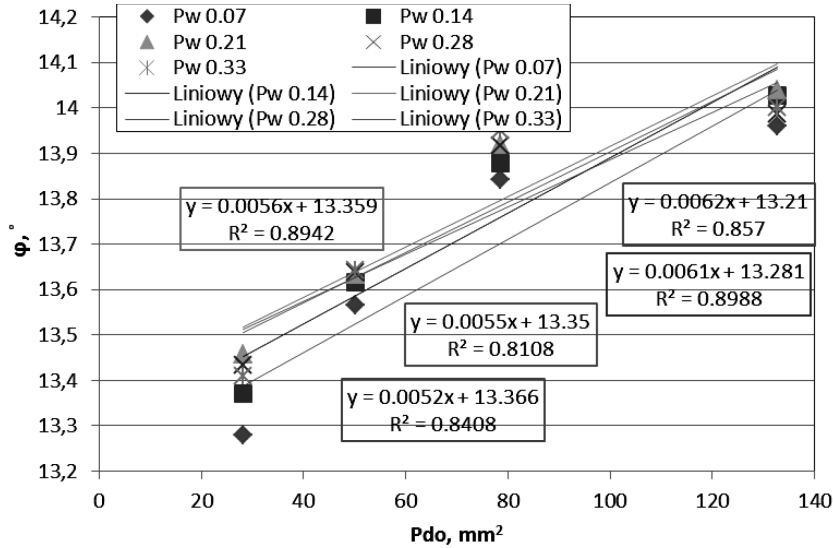

Fig. 11. Effect of cross-sectional area cylindrical nozzle (P_{do}) and the amount of water flow on the size of the angle of the spray ϕ mist flow

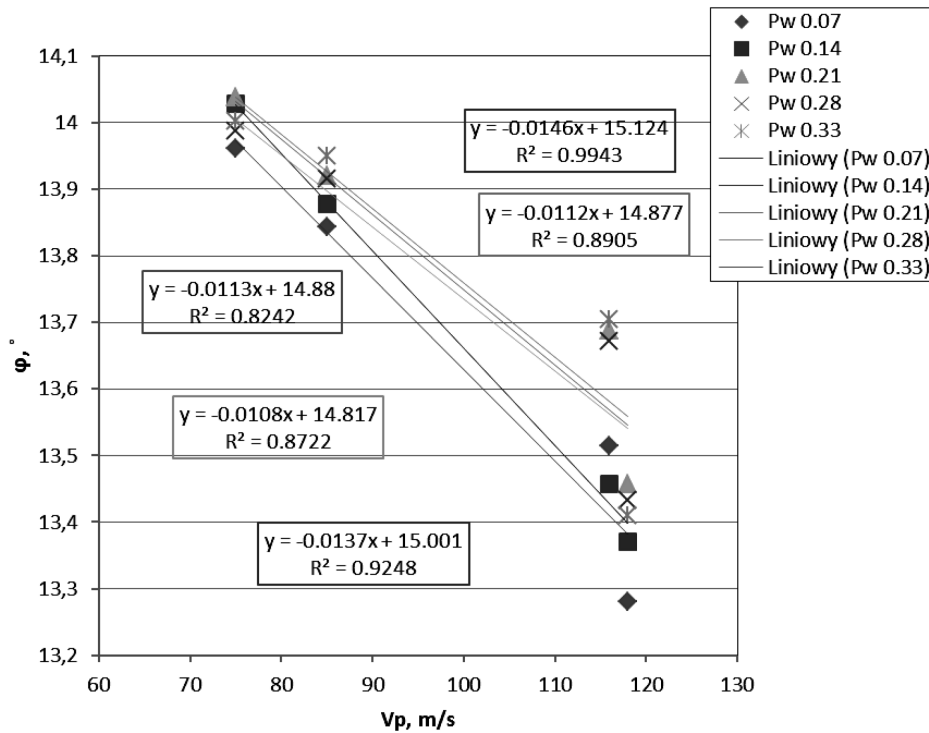







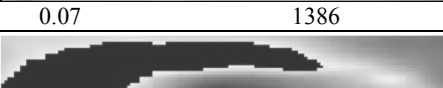

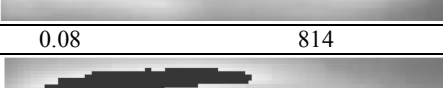

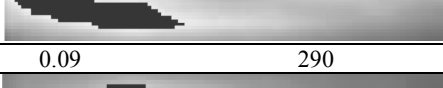
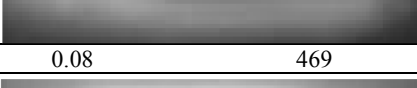
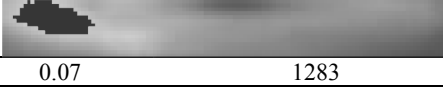
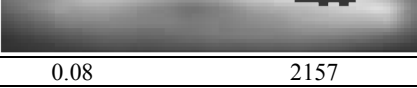



Fig. 12. Effect of flow velocity of water mist from the cylindrical emitting nozzle and the amount of flow of water on spray angle ϕ of the water mist stream

Table 2.

Areas of binary thermographic images of the surface-cooled casting die temperatures in the range 66.5÷86.5°C set with use of the computer image analysis

Air flow, l/min	Circular nozzle		Rectangular nozzle	
	Water flow, l/min	Binary area, px ²	Water flow, l/min	Binary area, px ²
225	0.07	3382	0.06	3498
				
300	0.06	2932	0.07	3093
				
300	0.08	1479	0.07	2386
				
400	0.06	1715	0.08	1074
				
400	0.07	1386	0.08	437
				
400	0.08	814	0.09	222
				
500	0.09	290	0.08	469
				
500	0.07	1283	0.08	2157
				
600	0.07	1283	0.08	2157
				

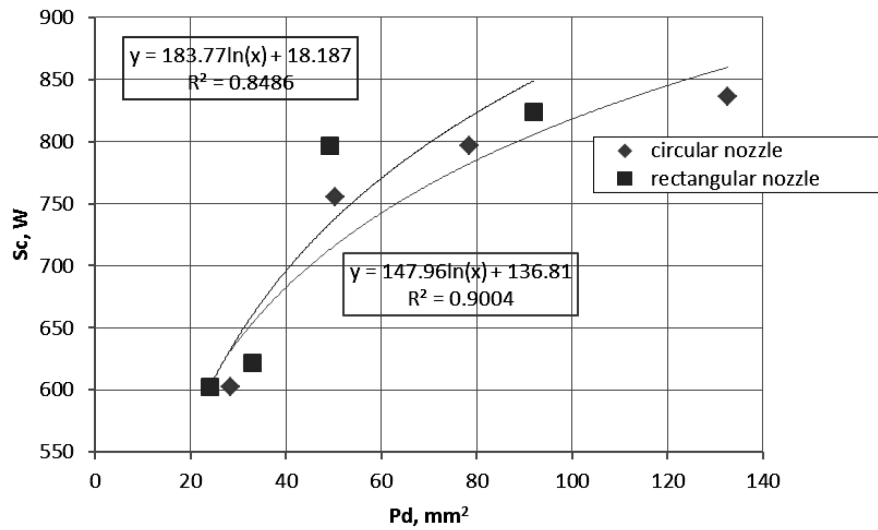

Fig. 13. Influence of the nozzle cross-sectional area of the heat flux received from the cooled wall of casting die

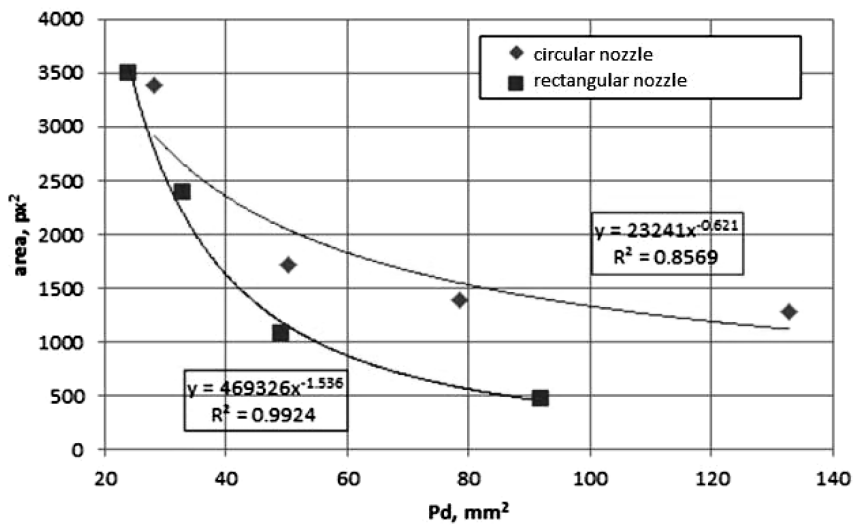

Fig. 14. Influence of the nozzle cross-sectional area of the size of the temperature field in the 66.5, 86.5°C surface-cooled of casting die

Table 3.

A mathematical model of the incoming heat flux depending on the flow of air and water and temperatures cooled surface of casting die

Model Sc	Test-F	R ² (adj)	Standard error	P-value
	174.59	0.99	6.40	0.0057
$Sc = 684.979 + 0.364427 * Pp - 0.0432165 * \text{Obszar} - 0.00473968 * Pd^2, W$				

4. Conclusions

The main conclusions of the work are as follows:

- swirl jet, in the range 0.1÷0.6 l/min of water flow provides a much more effective spraying water than stream nozzle and allows to control the spraying angle values in the range of 51÷76°,
- increasing the air flow in the range 150÷200 l/min causes in approximately double decrease the size of water droplets in the mist of water,
- to increase the air flow of 150÷350 l/min and water flow in the range 0.2÷0.6 l/min reduces the amount of mist droplets in the stream water and increases the flow velocity of water mist, where the average droplet velocity varies in the range from about 4÷6 m/s,
- increasing the cross-sectional area of water flow nozzle and spray angle increases fuel spray mist and the increase of the nozzle cross-sectional area decreases the flow velocity of stream water mist,
- the size and droplet velocity, the distance between the droplets in the stream generated mist and casting die cooling efficiency can be described by mathematical models as a function of parameters of the stream water mist, the surface temperature field-cooled of casting die and nozzle geometry.

Acknowledgements

The work was made as a part of the research project No. N N508 399237 financed by funds for science in the years 2009-2012 by the Polish Ministry of Science and Higher Education

References

- [1] Władysiak R. (2007). Effective Intesification Method of Die Casting Process of Silumins. *Archives of Metallurgy*. 52 (3), 529-534.
- [2] Władysiak R. (2007). Assessment of Effectiveness of Water Mist Cooling of Casting Die. *Archives of Foundry Engineering*. 7 (4), 175-182.
- [3] Władysiak R. (2008). Water mist effect on heat transfer coefficient in cooling of casting die. *Archives of Foundry Engineering*. 8 (3), 227-236.
- [4] Władysiak R. (2008). Water mist effect on cooling range and efficiency of casting die. *Archives of Foundry Engineering*. 8 (4), 213-218.
- [5] Władysiak R. (2010). Effect of water mist on cooling process of casting die and microstructure of AlSi11 alloy. *Archives of Metallurgy and Materials*. 55 (3), 939-946.
- [6] Władysiak R. (2010). Water mist effect on cooling process of casting die and microstructure of AlSi9 alloy. *Archives of Foundry Engineering*. 10 (2), 185-194.
- [7] Władysiak R. (2011). Heat transfer analysis during cooling of die with use of water mist. *Archives of Foundry Engineering*. 11 (2), 167-174.
- [8] Orzechowski Z., Prywer J. (2008): *Preparation and use of spray liquid*. Warszawa: WNT.