

K. STANISZEWSKI\*, S. SIKORA\*, J. CZUCHRYJ\*

## RADIOGRAPHIC QUALITY ASSESSMENT OF WELDED JOINTS IN BUILDING STRUCTURES PRODUCED ACCORDING TO REQUIREMENTS OF STANDARD EN-1090-2, QUALITY LEVEL "B +"

### RADIOGRAFICZNA OCENA JAKOŚCI ZŁĄCZY SPAWANYCH W KONSTRUKCJACH BUDOWLANYCH WYKONYWANYCH WEDŁUG WYMAGAŃ NORMY EN-1090-2, NA POZIOMIE JAKOŚCI „B+”

While assessing the quality of welded joints it may become necessary to establish various quality levels in the same joint or implement specific requirements for an already adopted quality level. The latter case can be observed in standard EN 1090-2, in which additional requirements were adopted for quality level B and thus a new quality level designated as B+ was created. Most of the additional requirements are concerned with imperfections detected by means of radiography. For this reason it was necessary to compare the principles governing the assessment of the quality of welded joints from radiographic examination point of view, according to the requirements of standard EN ISO 5817 and those of EN 1090-2. A conducted comparative analysis aims at optimising the aforesaid principles in relation to the requirements presented therein.

Podczas określania jakości złączy spawanych może być konieczne ustalenie różnych poziomów jakości w tym samym złączy lub wprowadzenie szczególnych wymagań dla przyjętego poziomu jakości. Ostatni przypadek zaobserwowano w nowej normie EN 1090-2, w której dla poziomu jakości B ustalono wymagania dodatkowe. Nowy poziom jakości oznaczono symbolem B+. Większość dodatkowych wymagań dotyczy niezgodności wykrywanych metodą radiograficzną. Z tego powodu porównano zasady oceny jakości złączy spawanych z punktu widzenia kontroli radiograficznej według wymagań norm EN ISO 5817 i EN 1090-2. Przeprowadzona analiza porównawcza powinna przyczynić się do zoptymalizowania tych zasad ze względu na przedstawione w normach wymagania.

#### 1. Introduction

A required quality level of welded joints should be established prior to their production. Typically, one quality level is established for a single joint. In some cases, however, it may become necessary to establish various quality levels in the same welded joint or introduce detailed requirements for a level selected for the production of a joint. The latter case was observed in standard EN 1090-2:2009, in which additional requirements were established for the quality level "B"; the new quality level being designated "B+". Most of the additional requirements refer to imperfections detected by means of a radiographic method. For this reason it was necessary to undertake a task consisting in the comparison of the principles of the assessment of quality of welded joints on the basis of radiograms, following the requirements of standards EN ISO 5817 and of EN 1090-2. The purpose of the comparison is to optimise these principles due to the requirements presented in the standards.

One should note that radiography dominates among the most common methods of non-destructive tests applied in industry. For this reason, the knowledge of the principles gov-

erning this area is of great significance from a technical diagnostics point of view.

#### 2. Quality levels of welded joints and classes of structure execution

In standard EN ISO 5817, for materials of thickness exceeding or equal to 0.5 mm, three sets of dimensional values were established. These sets, referred to as quality levels, have been designated with capital letters of B, C and D. The quality level B corresponds to the highest requirements concerning welded joints, level D – to the lowest, whereas the quality level C is concerned with intermediate requirements (Fig. 1).

The selection of a specific quality level should allow for a design to be executed, anticipated processing, types of load affecting the product, its operating conditions and the consequences of a potential failure. Other crucial selection criteria include economic aspects both with respect to the cost of welding as well as that of inspection, testing and repair, if any, of the product. Standard EN ISO 5817 includes types of welding imperfections typical of various welding methods. Only those

\* INSTITUTE OF WELDING, 44-100 GLIWICE, BL. CZESŁAWA 16-18 STR., POLAND

of the foregoing require consideration which are characteristic of a given process and application.

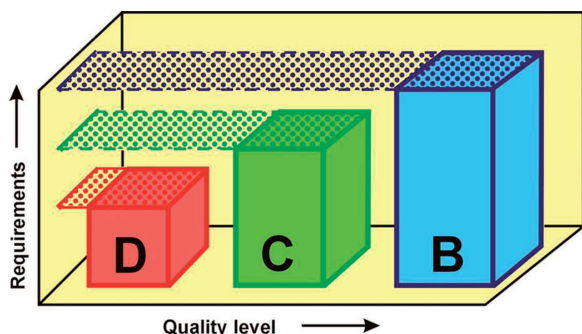

Fig. 1. Quality levels acc. to EN ISO 5817, in relation to related requirements

Standard EN 1090-2, concerning the production of structures made of steel grade not higher than S960, irrespective of their types and shapes (e.g. buildings, bridges, solid wall- or lattice elements, exposed to fatigue or seismic activity etc.) contains requirements in relation to four so-called structure execution classes, namely EXC1, EXC2, EXC3 and EXC4. Class EXC1 is characterised by the lowest requirements, whereas EXC4 – by the highest ones (Fig. 2).

Execution classes may be applied to the whole structure, its part or selected elements. Thus, more execution classes are possible within one structure. An element or a group of

elements are usually assigned to one execution class. The selection of a given execution class is conditioned by factors affecting its reliability. In general, while establishing an execution class one should take into account as follows:

- classes of consequences – characterising structural reliability;
- application categories – characterising the risk related to the application of structure;
- production categories – characterising the risk related to the execution of structure.

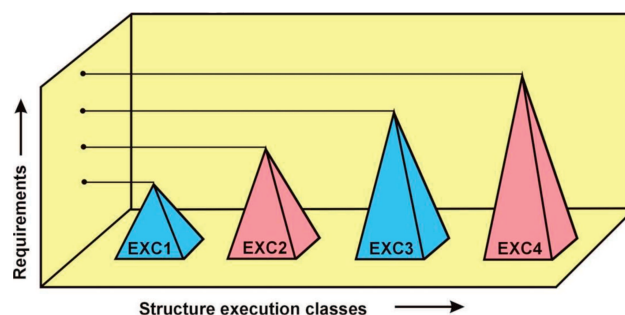

Fig. 2. Structure execution classes according to EN 1090-2 in relation to related requirements

The criteria of acceptance of welding imperfections present in welded joints were established for individual steel structure execution classes (Table 2).

TABLE 1

Dependences recommended for establishing structural classes

No.	DESCRIPTION	STRUCTURE EXECUTION CLASSES											
		CC1				CC2				CC3			
1	Classes of consequences	CC1				CC2				CC3			
2	Application categories	SC1		SC2		SC1		SC2		SC1		SC2	
3	Production categories	PC1	PC2	PC1	PC2	PC1	PC2	PC1	PC2	PC1	PC2	PC1	PC2
4	<b>Classes</b>	<b>EXC1</b>	<b>EXC2</b>	<b>EXC2</b>	<b>EXC2</b>	<b>EXC2</b>	<b>EXC2</b>	<b>EXC3</b>	<b>EXC3</b>	<b>EXC3<sup>*)</sup></b>	<b>EXC3<sup>*)</sup></b>	<b>EXC3<sup>*)</sup></b>	<b>EXC4</b>

\*) Class EXC4 is applied to special structures in view of national regulations or to structures, the destruction of which would entail extreme consequences.

Note: if no execution class has been specified, one should apply class EXC2.

TABLE 2

Criteria of acceptance of welding imperfections (quality levels) in relation to structure execution class

No.	STRUCTURE EXECUTION CLASS	JOINT QUALITY LEVEL ACC. TO EN ISO 5817
1	EXC1	D
2	EXC2	C and D <sup>1)</sup>
3	EXC3	B
4	EXC4	B+ <sup>2)</sup>

<sup>1)</sup> The quality level D is allowed in case of such imperfections as undercuts (5011, 5012), overlap (506), (arc) ignition mark (601) and the closing of a crater (2025).

<sup>2)</sup> Quality level not specified by the requirements of standard EN ISO 5817.

Note: while establishing acceptance criteria, the imperfections in the form of improper toe of a weld (505) and micro incomplete fusion (4014) were not taken into consideration.

According to Table 2, the quality level D of welded joints is required while executing structures in accordance with the least restrictive execution class EXC1. The quality levels C and D (specified only due to the presence of some imperfections) are valid in case of a more restrictive execution class i.e. EXC2. The quality level B is required in case of a more restrictive structure execution class EXC3. The most restrictive requirements related to welded joints (quality level B+) apply to the execution of special steel structures or structures, the failure of which might cause grave consequences. If, in the design of structure, no execution class has been specified, one should apply class EXC2.

It is anticipated that the nearest future will see a wide range of application of standard EN 1090-2. For this reason, from a technical point of view, it is crucial to analyse proposed requirements compared to the so-far applied regulations.

### 3. Acceptance criteria for welding imperfections on grounds of radiographic tests following EN ISO 5817 and EN 1090-2

The comparison of acceptance criteria for welding imperfections detected by means of radiography were carried out for butt-welded steel joints. Table 3 presents requirements concerning individual imperfections in case of the quality levels B and B+.

The analysis of Table 3 allows a conclusion that recommendations presented in comparable standards are very strict about the presence of such imperfections in welded joints as continuous or intermittent undercuts on the face of a weld (5011, 5012). The presence of the aforesaid imperfections is not allowed in case of the thickness of base metal of 0.5 – 3 mm. In case of thickness exceeding 3 mm, the recommendations of standard EN ISO 5817 allow the presence of small undercuts on the face of a weld, provided that  $h \leq 0.5\text{mm}$  (Fig.3.)

TABLE 3

Comparison of acceptance criteria for welding imperfections for quality levels B and B+ acc. to EN ISO 5817 and EN 1090-2, for butt-welded joints made of steels tested with radiographic method

No.	IMPERFECTION	ACCEPTANCE CRITERIA	
		Acc. to EN ISO 5817 Quality level "B"	Acc. to EN 1090-2 Quality level "B+"
1.	UNDERCUTS (5011, 5012)	For $t = 0.5-3$ mm: not allowed For $t > 3$ mm: $h \leq 0.05t$ ; max 0.5 mm	not allowed
2.	BLOWHOLES (2011) AND EVENLY DISTRIBUTED (2012)	w.p. $A1 \leq 1\%$ ; w.w. $A1 \leq 2\%$ ; $d \leq 0.2s$ ; max 3 mm	$d \leq 0.1s$ ; max 2 mm
3.	POROSITY CLUSTER (LOCATED) (2013)	$A1 \leq 4\%$ $d \leq 0.2s$ ; max 2 mm	$d \leq 0.1s$ ; max 2 mm
4.	LINEAR POROSITY (2014)	w.p. $A1 \leq 2\%$ w.w. $A1 \leq 4\%$ $d \leq 0.2s$ ; max 2 mm	$d \leq 0.1s$ ; max 2 mm
5.	SLAG INCLUSION (301) FLUX INCLUSION (302) OXIDE INCLUSION (303)	$h \leq 0.2s$ ; max 2 mm $l \leq s$ ; max 25 mm	$h \leq 0.1s$ ; max 1 mm $l \leq s$ ; max 10 mm
6.	METALLIC INCLUSIONS (304) OTHER THAN COPPER	$h \leq 0.2s$ ; max 2 mm	$h \leq 0.1s$ ; max 1 mm $l \leq s$ ; max 10 mm
7.	COPPER INCLUSION (3042)	not allowed	$h \leq 0.1s$ ; max 1 mm $l \leq s$ ; max 10 mm
8.	LINEAR SHIFT (507)	Plates and longitudinal welds for $t = 0.5-3$ mm: $h \leq 0.2$ mm + 0.1t. Plates and longitudinal welds for $t > 3$ mm: $h \leq 0.1t$ ; max. 3 mm. Circumferential welds for $t \geq 0.5$ mm: $h \leq 0.5t$ ; max. 2 mm.	$h \leq 0.05t$ ; max. 2 mm
9.	ROOT CONCAVITY (515)	For $t = 0.5-3$ mm: not allowed For $t > 3$ mm: $h \leq 0.05t$ ; max. 0.5 mm. Short imperfections allowed	not allowed

t – wall or plate thickness (nominal); l – length of imperfection or indication; w.p. – single layer; w.w. – numerous layers; h – height or width of imperfection; d – blister diameter; A1 – area containing blisters; s – nominal thickness of butt weld.

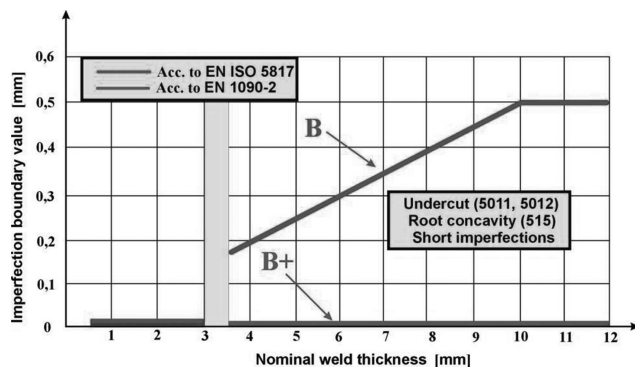

Fig. 3. Boundary values of undercuts on weld face and root concavities for quality levels B and B+

Almost identical regulations apply to root concavities (515). Their presence in welded joints is not allowed if the thickness of base metal is contained within the range 0.5-3 mm. For thickness exceeding 3 mm only the requirements of standard EN ISO 5817 allow the presence of concavities, if  $h \leq 0.5\text{mm}$ , yet of only short ones i.e. where  $l \leq 25\text{mm}$  (Table 3, Fig. 3).

Figure 3 reveals that undercuts responsible for the reduction of the cross-section of a joint transmitting service load are assessed with utmost strictness. Reference publications [1], however, contain information about tests, whose results allow a conclusion that paying such immense attention to the presence of undercuts in welded joints as nowadays is not adequately justified. Neither is strongly negative assessment of root concavities; this being due to the fact that the reduction of the cross-section of a load-carrying joint containing cavities is usually compensated by the height of the reinforcement of a weld and by higher mechanical properties of the latter, if compared with those of the base metal (Fig. 4).

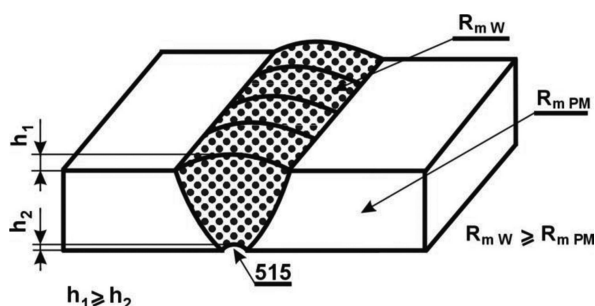

Fig. 4. Visual presentation of justification of less strict assessment of root concavities

According to the requirements of standard EN ISO 5817, the boundary value of blowholes (2011) and evenly distributed blisters (2012) is the same and amounts to 3 mm. According to the requirements of standard EN 1090-2, however, the boundary value of these imperfections is lower and amounts to 2 mm (Fig. 5). As can be seen in Figure 5, the requirements of standard EN 1090-2 are more restrictive if compared with those of standard EN ISO 5817.

In addition, standard EN ISO 5817 specifies the allowed area of detected blisters in relation to the projected area of the joint section under assessment. The allowed values for this relation are 1% and 2% for a single-layer- and multi-layer weld respectively. Standard EN 1090-2 does not allow for such

a limitation. Thus, from the point of view of the number of blisters present in a weld, the requirements of standard EN ISO 5817 are higher than those of EN 1090-2.

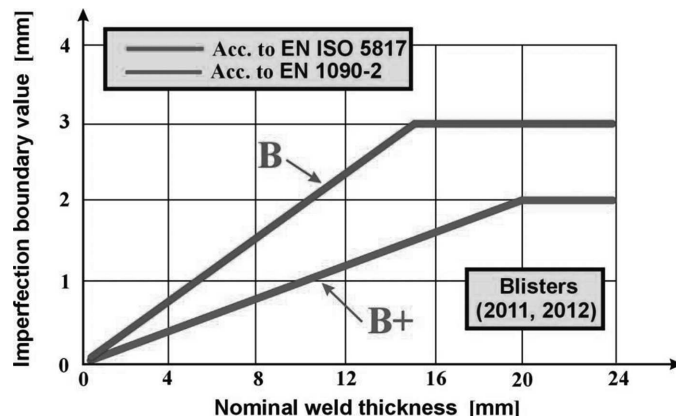

Fig. 5. Boundary values for blowholes and evenly distributed blisters for quality levels B and B+

The boundary values for blisters located in porosity clusters (localised porosity – 2013) and linear porosity (2014) are the same (Fig. 6) for joint thicknesses exceeding or equal to 20 mm.

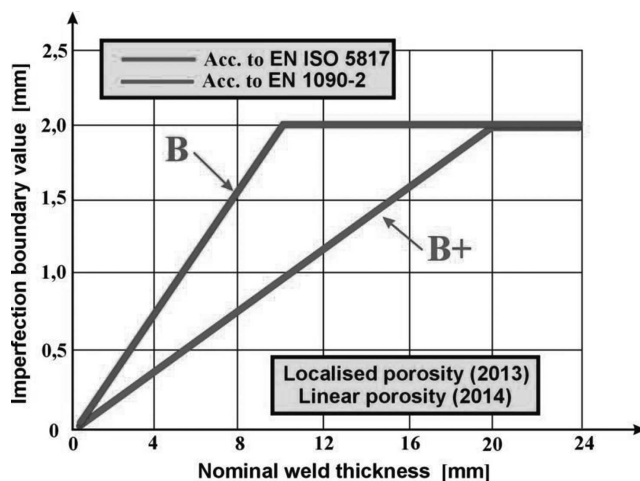

Fig. 6. Boundary values for localised and linear porosity for quality levels B and B+

The requirements of standard EN ISO 5817, however, similarly as the requirements concerned with blisters 2011 and 2012, additionally limit the allowed projected area of imperfections or indications. Standard EN 1090-2 does not contain any recommendations in relation to this matter. Thus, blisters of a diameter smaller than that specified in standard EN ISO 5817 (for joint thickness up to 20 mm) are allowed, without any limitation of their number. In other words, the requirements for localised and linear porosity specified in standard EN 1090-2 are less restrictive, if compared with those of standard EN ISO 5817.

The welded joints of building structures are also allowed for the presence of solid inclusions (i.e. foreign matter bound in the metal of a weld) in the form of slag (301), flux (302) and oxide (303) inclusions as well as metallic inclusions other than those with copper (304). Figure 7 presents the boundary

values of these inclusions according to the requirements of standards EN ISO 5817 and those of EN 1090-2.

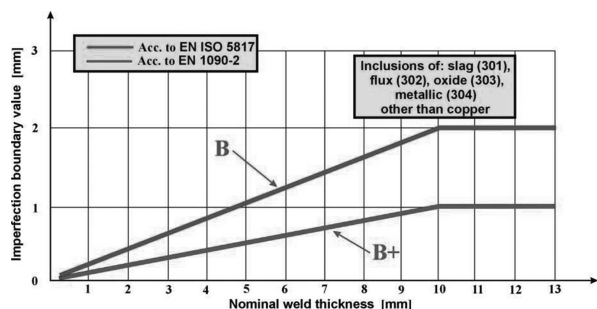

Fig. 7. Boundary values for solid inclusions for quality levels B and B+

As can be seen in Figure 7, in case of the quality level B, the boundary value of solid inclusions other than copper amounts to 2 mm. In case of the quality level B+, the value of these inclusions has been specified as 1 mm. The requirements of standard EN 1090-2 are thus more restrictive than those of standard EN ISO 5817. The analysis of the allowed length of solid inclusions leads to a similar conclusion.

Separate requirements were formulated with reference to metallic inclusions in the form of copper (3042) (Fig. 8).

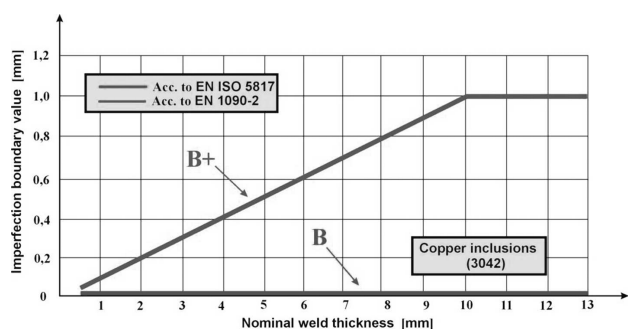

Fig. 8. Boundary values for copper inclusions for quality levels B and B+

Copper easily penetrates grain boundaries both in the weld and in the heat affected zone. By forming low-melting phases, copper significantly lowers the mechanical properties of a joint, which, in many cases leads to the generation of hot cracks of inter-crystalline character. For this reason, welding engineering treats copper inclusions in a special manner. As can be seen in Figure 8, the requirements of standard EN ISO 5817 exclude the presence of copper inclusions (3042) in case of the quality level B. In turn, in case of the quality level B+, the requirements of standard EN 1090-2 allow the presence of copper inclusions of the boundary value  $h \leq 1$  mm and length not exceeding 10 mm. The comparison of the requirements of the standards under analysis reveals that in case under discussion it is standard EN 1090-2 that is less restrictive.

The analysis of Figure 9 (a and b) leads to a conclusion that in each variation of linear shifts more restrictive are the requirements of standard EN 1090-2 if compared with those of standard EN ISO 5817. According to EN 1090-2 the boundary value of the linear shift of circumferential welds is the same as that specified in the requirements of standard EN ISO 5817, yet only for the thickness of elements (to be joined)  $t \geq 40$  mm.

For  $t < 40$  mm, the allowed values of shifts are lower than in case of the requirements specified in standard EN ISO 5817.

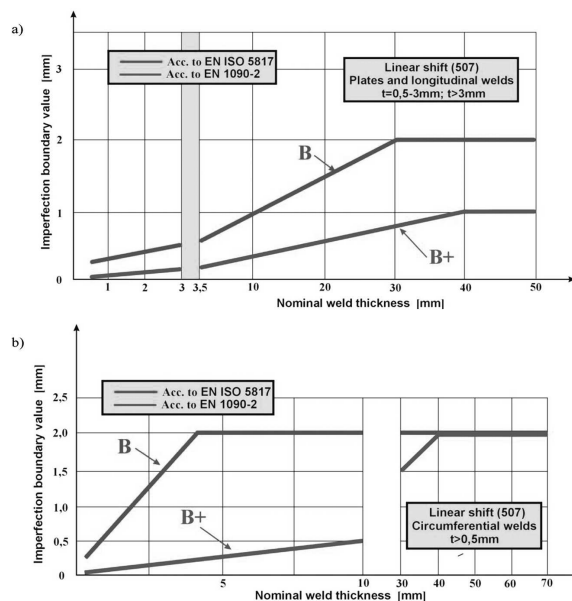

Fig. 9. Boundary values for linear shifts quality levels B and B+: a) plates and longitud. welds of thickness  $t = 0.5 - 3$  mm and  $t > 3$  mm, b) circumferential joints of thickness  $t \geq 0.5$  mm

#### 4. Summary and conclusions

The comparison of standards EN ISO 5817 and EN 1090-2 revealed (for the acceptance criteria characterised by the strictest requirements i.e. for the quality levels B and B+) the similarities of the radiography-based assessment principles concerning the quality of welded joints. The assessment is the same in case of butt joints of thickness  $t = 0.5 - 3$  mm and welding imperfections in the form of undercuts (5011, 5012) as well as short root concavities (515). Yet, for joints of thickness  $t > 3$  mm one can observe higher restrictiveness of standard EN 1090-2. In case of other welding imperfections, the analysis of their boundary values leads to a conclusion that the requirements of standard EN 1090-2 are more restrictive than those of standard EN ISO 5817. An exception is copper inclusions (3042), whose presence on the quality level B+ is allowed by the requirements of standard EN 1090-2. From a materials science point of view, such an approach is difficult to understand.

The comparative analysis reveals the ambiguity of acceptance criteria established for various types of blisters (2011, 2012, 2013 and 2014). The requirements of standard EN 1090-2 (concerning the boundary values of these imperfections) appear slightly more restrictive than those of standard EN 5817. However, the limitation of the projection area of indications referred to in standard EN 5817 leads to the opposite conclusion, which is easily visible in a hypothetical example (Fig. 10).

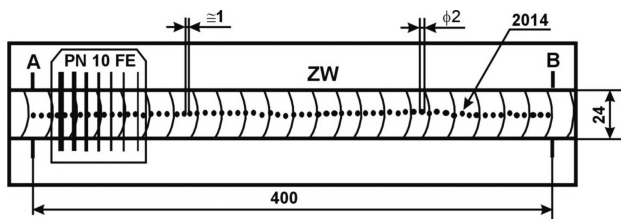

Fig. 10. Sketch of radiograph of 20mm-thick multilayer butt joint with linear porosity

Calculations: area of single blister –  $\frac{\pi d^2}{4} = \frac{3,14 \cdot 2^2}{4} = 3,14 \text{ mm}^2$ , for quality level B: reference area –  $w_p \cdot l = 24 \cdot 400 = 9600 \text{ mm}^2 \rightarrow 4\% = 384 \text{ mm}^2$ ,  $384 \div 3,14 \approx 122 \text{ blisters}$ , for quality level B+:  $400 \div 3 \approx 133 \text{ blisters}$

If in a multilayer butt joint linear porosity was observed, according to the calculations (Fig. 10), it could contain 122 blisters in case of the quality level B and 133 blisters in case of the quality level B+. In order to facilitate the calculations it was necessary to assume that all blisters were identical, their maximum dimension was  $d = 2 \text{ mm}$  and distances between them amounted to approx. 1 mm; the principle of summation of blisters is not applied if the distances between them are shorter than the length of their diameter.

On grounds of the comparison it was possible to reach the following conclusions:

- from the point of view of the boundary values of welding imperfections, the requirements of the quality level B+ are characterised by higher restrictiveness than those of the quality level B;
- analysis of the requirements related to the projection area of various blisters leads to a conclusion that the requirements adopted for the quality level B+ are similar to (or lower than) those adopted for the quality level B;
- widespread implementation of standard EN 1090-2 on an industrial scale should be preceded by a substantive dis-

cussion on the legitimacy of the adoption of special acceptance requirements in the form of the quality level B+.

#### REFERENCES

- [1] T. Robakowski, Wpływ w złączach spawanych na własności eksploatacyjne konstrukcji spawanych (Impact of welded joints on service properties of welded structures). Wydawnictwo Instytutu Spawalnictwa (Publication of Instytut Spawalnictwa). Gliwice 1997.
- [2] J. Brózda, J. Czuchryj, Radiografia złączy spawanych (Radiography of welded joints). Wydawnictwo Instytutu Spawalnictwa. Gliwice 2005.
- [3] J. Czuchryj, H. Papkała, A. Wiśniewski, Niezgodności w złączach spawanych (Imperfections in joints). Wydawnictwo Instytutu Spawalnictwa. Gliwice 2005.
- [4] K. Staniszewski, S. Sikora, J. Czuchryj, Ocena jakości złączy spawanych w konstrukcjach budowlanych na podstawie badań radiograficznych i poziomu jakości „B+” (Quality assessment of welded joints in building structures on grounds of radiographic tests and quality level “B+”). Bulletin of Instytut Spawalnictwa in Gliwice 5 (2011).
- [5] G. Golański, P. Gawień, J. Słania, Examination of coil pipe butt joint made of 7CrMoVTiB10-10 (T24) steel after service. Archives of Metallurgy and Materials 57, 2 (2012).
- [6] M. Urzyniok, K. Kwieciński, J. Słania, Analysis of problems occurring welding of new generation of bainitic steel 7CrMoVTiB10-10 (T24), Archives of Metallurgy and Materials 57, 3 (2012).
- [7] G. Golański, J. Słania, Effect of different heat treatments on microstructure and mechanical properties of the martensitic GX12CrMoVNbN91 cast steel, Archives of Metallurgy and Materials 57, 4 (2012).
- [8] B. Ślęzak, J. Słania, T. Węgrzyn, A.P. Silva, Process Stability evaluation of manual metal arc welding using digital signals. Materials Science Forum 730-732, 847-852 (2012).