

A. TUROWSKA*, J. ADAMIEC*, T. RZYCHOŃ*

TECHNOLOGY OF REPAIRING QE22 ALLOY CASTS

TECHNOLOGIA NAPRAWY ODLEWÓW ZE STOPU QE22

Hot cracking is one of the main problems involved in the casting of magnesium alloys and their joining by means of welding. Despite many research done, this type of cracking still constitutes a major problem in industrial practice. The present paper describes the impact of metallurgical, structural and technological factors on the susceptibility of the QE22 alloy to hot cracking of the repaired joints. A technology of repairing the QE22 alloy casts by means of welding and pad welding, was developed. The technology meets the qualification requirements according to EN 15614-4.

Keywords: QE22, Cast Magnesium Alloy, Weldability of Magnesium Alloys, Repairing of Magnesium Alloy

Pękanie gorące jest jednym z głównych problemów odlewania stopów magnezu oraz ich łączenia przez spawanie. Pomimo licznych badań, w praktyce przemysłowej ten rodzaj pęknięcia nadal stanowi istotny problem. W pracy przedstawiono wpływ czynników metalurgicznych, konstrukcyjnych i technologicznych na skłonność stopu QE22 do pęknięcia gorącego złączy naprawczych. Opracowano technologie naprawy odlewów ze stopu QE22 za pomocą spawania i napawania spełniającą warunki kwalifikowania technologii wg EN 15614-4.

1. Introduction

Pursuant to ASTM B80 (MCMgRE2Ag2Zr according to PN-EN 1753), the QE22 cast magnesium alloy belonging to a group of the Mg-Ag-RE-Zr alloys can work in a temperature of up to 200°C [1]. Addition of silver (2-3%) increases the strength properties as a result of precipitation hardening. Zirconium modifies the grain size of the alloy, increasing its mechanical properties in the ambient temperature [2]. Rare earth metals are added to magnesium alloys to improve their resistance in elevated temperatures and to increase their creep resistance. In case of alloys containing silver, the RE elements are added as a didymium, i.e. a mixture of neodymium (about 85% wt.) and praseodymium. Neodymium increases strength in elevated temperature. It is connected with a limited solubility of neodymium in magnesium and with stable precipitates strengthening the internal areas and boundaries of the α -Mg solid solution grains [2].

In the aerospace industry, the QE22 alloy has been applied in the production of motor housing casts, helicopter gearbox housings and rotor heads, whereas in the car industry and military industries it has been used mainly as the cast elements working in elevated temperatures in the range 170°C – 200°C [3-4].

In the process of manufacturing magnesium alloy casts, certain defects may occur, which are repaired with the use of welding technologies. The most frequent reason for rejecting the repaired cast or construction is hot cracking occurring in

the welding process. Hot cracking is considered to be caused mainly by decreased metal ductility in the range of high temperature brittleness and metal deformation in the crystallization process, which results in the loss of material strength. The upper limit of this range during welding corresponds to the nil strength temperature (NST), and the lower one corresponds to the nil ductility temperature during heating (NDT) or ductility recovery temperature during cooling (DRT) (Fig. 1) [5-6].

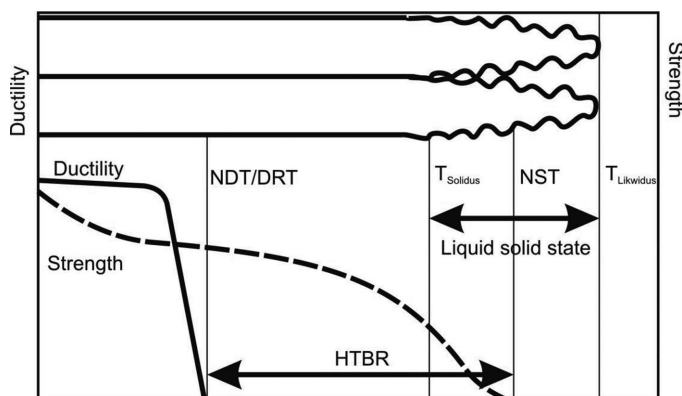

Fig. 1. High temperature brittleness range (HTBR) determining the hot cracking of welds [17]

Metallurgical factors – chemical composition and structure of the joint, construction factors – mass and complexity of the cast, and technological factors – welding method, weld-

* INSTITUTE OF MATERIALS SCIENCE, POLITECHNIKA ŚLĄSKA [SILESIAN UNIVERSITY OF TECHNOLOGY], 8 KRASIŃSKIEGO STR., 40-019 KATOWICE, POLAND

ing parameters and thermal cycle, have an impact on possible repairs of the casts [7-8].

This paper describes the technology of repairing QE22 alloy casts and takes into account impact of these many factors. The developed technology has been verified in a test repair of an experimental cast.

2. Material experimental

Investigations were performed with the use of cast magnesium alloy containing silver, rare earth elements and zirconium, corresponding to the MSR-B specification, according to Magnesium Elektron (QE22 according to ASTM B80 and MCMgRE2Ag2Zr according to PN-EN 1753) [1]. Chemical composition of the obtained melt and nominal chemical composition according to PN-EN1753 standard is given in Table 1. Mechanical properties and heat treatment of the alloy investigated are also listed. The microstructure after casting and heat treatment is shown in Figure 2.

TABLE 1
 Chemical composition and properties of the QE22 alloy

Chemical composition of QE22 alloy [% wt.]					
	Zr	RE	Ag	Others	Mg
Melt no. 4377	0.46	2.57	2.4	<0.05	residue
PN EN 1753	0.4-1.0	2.0-3.0	2.0-3.0	<0.01	residue
Mechanical properties					
alloy	R _m , MPa	R _e , MPa	A ₅ , %	HV3	
QE22	240	185	2	80	
Heat treatment (T6)	Solution heat treatment 8h/525°C/air + ageing 16h/200°C/air				

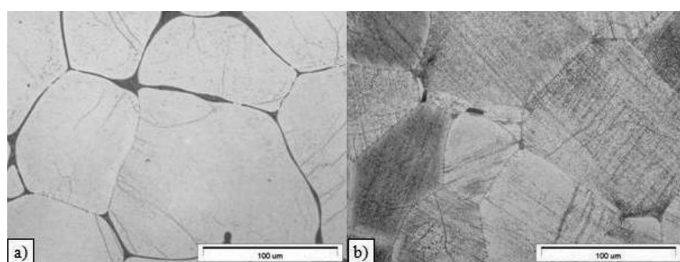

Fig. 2. Microstructure of the QE22 alloy: a) after casting, b) after solution heat treatment and ageing [7]

The microstructure of the QE22 alloy containing 2.57% of rare earth elements and silver addition (2.5%) in as-cast condition consists on Mg(α) solid solution crystals and [Mg(α)+(Mg,Ag)₁₂Nd] eutectic network formed on grain boundaries (Fig. 2a) [9]. After solution heat treatment and ageing the microstructure consist of Mg(α) matrix and fine precipitates of (Mg,Ag)₁₂Nd phase at grain boundaries and grain interiors (Fig. 2b) [9-10].

3. Assessment of the impact of metallurgical factors on the susceptibility of the welded joints to hot cracking

Theories describing the joint cracking in the range of high temperature brittleness developed in the second half of the 20th century have not been verified in direct tests due to a lack of technical possibilities. The development of a procedures for the Gleeble thermo-mechanical simulator at the beginning of this decade enabled to verify these theories and to determine critical temperatures from high temperature brittleness range [9, 11].

The purpose of tests carried out with the use of the Gleeble 3800 thermo-mechanical simulator, described in [9], was to determine: the thermal cycle in the heat affected zone, the nil strength temperature (NST), the nil ductility temperature (NDT), the ductility recovery temperature (DRT), the high temperature brittleness range and the R_f. cracking resistance factor.

The NDT temperature determined for the QE22 alloy in as-cast condition is equal to 490°C for the strain rate of 1 mm/s and 515°C for the rate of 20 mm/s. [9]. Analysis of the microstructure on the surface perpendicular to the fracture indicates that the cracks occur in the areas of the [Mg(α) + (Mg,Ag)₁₂Nd] melted eutectic mixture and develop along the network of precipitates of this eutectic mixture (Fig. 3a). Fractographic examinations of the fracture revealed (Mg,Ag)₁₂Nd crystallized intermetallic phase on the Mg(α) solid solution crystal surface. This confirms that the crack develops as a result of separation of the liquid formed from the melted eutectic mixture (Fig. 3b).

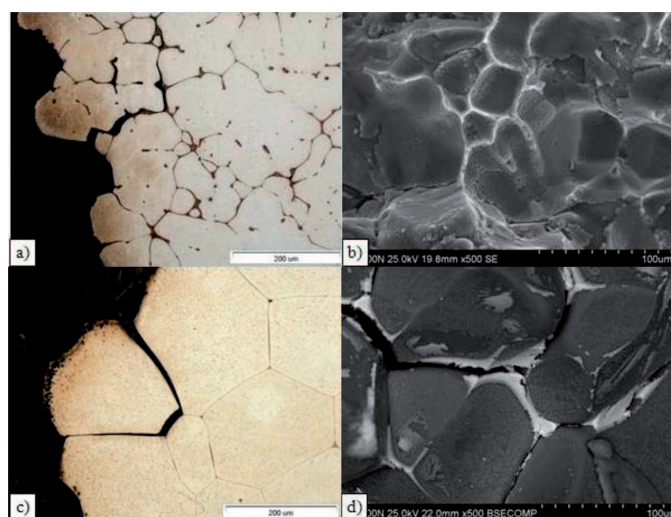

Fig. 3. Microstructure of the QE22 alloy: a) network of intercrystalline cracks after NDT test, as-cast condition, LM, b) fracture surface covered with (Mg,Ag)₁₂Nd crystallized phase, as-cast condition, SEM, SE, c) separated Mg(α) grain formed as a result of splitting of the thin layer of the intermetallic phase, heat-treated condition (T6), LM, f) cracked (Mg,Ag)₁₂Nd intermetallic phase on the surface of scrap cracks, heat-treated condition (T6), SEM BSE image

DRT ductility recovery temperature of the QE22 alloy in as-cast condition is equal to 500°C at the strain rate of 1 mm/s and 495°C in the rate 20 mm/s. In this case the hot cracks arise in the melted [Mg(α)+(Mg,Ag)₁₂Nd] eutectic mixture and develop along the wet boundaries of the Mg(α) crystals

[9]. The melted $(Mg,Ag)_{12}Nd$ phase crystallizes on the crystal surface, cracking under the impact of shrinkage. Range of the high temperature brittleness of the QE22 alloy without the heat treatment in equal to $37^{\circ}C$ i.e. from $500^{\circ}C$ to $537^{\circ}C$ (Fig. 4a). A similar phenomenon was observed in the alloy after a full heat treatment (Fig. 3c). It was found that in the cooling process, the cracks occur as a result of splitting of the liquid layer between the crystallized grains of the (α) solid solution (Fig. 3d). It was found out that when the temperature dropped below the solidus point, bridges of the crystallized $(Mg,Ag)_{12}Nd$ phase burst (Fig. 3d.). HTBR for the QE22 alloy after the heat treatment, both after solution heat treatment and after solution heat treatment and ageing does not differ pronouncedly. It is equal to $35\div 45^{\circ}C$ at the strain rate 1 mm/s and $40^{\circ}C$ at the strain rate 20 mm/s (Fig. 4b).

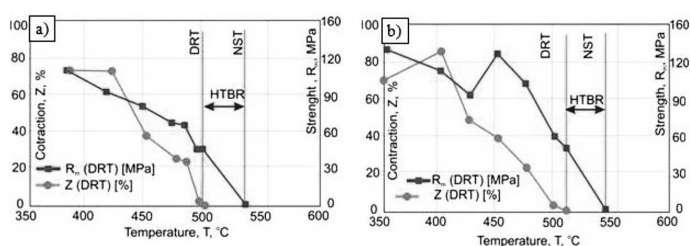

Fig. 4. Contraction and resistance of samples of QE22 alloys in temperature function (cooling, DRT test): a) material after casting, b) material after heat treatment (T6)

Therefore one can conclude that increase in the strain rate results in the extension of the range of high temperature brittleness. No significant impact of the heat treatment on the range of the high temperature brittleness has been noticed (Fig. 4). R_f – the crack resistance factor is the highest for an alloy as-cast at the strain rate 1 mm/s, which indicates that this alloy tends to crack in as-received condition.

4. Impact of microstructural factors on possible repairs of QE22 alloy casts

Basic microstructural factors affecting weldability include the shape of the cast, its rigidity and type of the joint. Impact of the cast rigidity on a susceptibility to hot cracking, assuming a fixed joint rigidity, was determined on the basis of the Fisco test results. In case of variable joint rigidity, the Houldcroft test was applied. The “transvarestraint” test was applied to assess impact of the strain rate and intensity during the recasting process. Results of these tests presented in papers [12-13] enabled to determine impact of microstructural factors on the high temperature brittleness of the QE22 alloy.

The Fisco test results described in the paper [12] showed that the QE22 alloy is resistant to hot cracking in the fixed rigidity conditions after casting. This susceptibility increases after solution heat treatment and after solution heat treatment and ageing (Fig. 5a). Therefore, the QE22 alloy in the fixed rigidity conditions should be welded after casting.

Methodology of the Houldcroft test was described in the paper [13]. The H index calculated as a ratio of the crack length for the whole sample length was chosen as a criterion for assessing a susceptibility to hot cracking of the alloy.

Analysis of the test results simulating welding in the conditions of the cast variable rigidity during the welding has showed that the QE22 alloy tends to hot crack during recasting (Figs. 5b, 6a). These cracks appear in the interdendritic region within in $Mg(\alpha)+\beta(Mg_{12}NdY)$ eutectic areas (Fig. 6b).

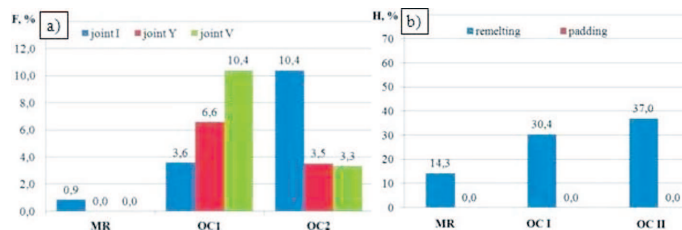

Fig. 5. Results of a susceptibility to hot cracking assessment of the QE22 alloy joints in conditions of: a) fixed stiffness (Fisco test), b) variable stiffness (Houldcroft test): MR – as-cast, OC I – solution heat treated, OCII – solution heat treated and aged

No hot cracks were noticed during pad welding. The QE22 alloy casts, which are characterized by a great variety in the wall thickness, should be repaired after casting, by using additional material with chemical composition similar as those of the basic material. Susceptibility to hot cracking of the QE22 alloy increases after heat treatment.

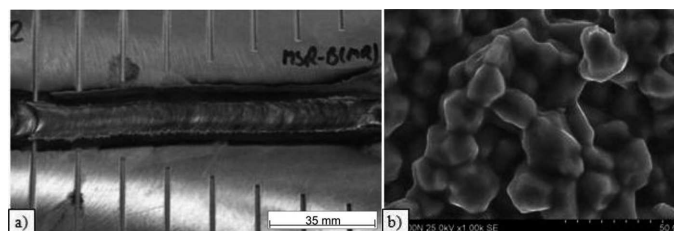

Fig. 6. Houldcroft test results for the QE22 alloy: a) a remelted plate with a visible crack in the weld axis, b) crack area in the weld penetration, SEM

The transvarestraint test, simulating a welding process with a forced strain, consists in a fast bending of flat samples, with the use of a cylindrical die block, while remelting the material across. Full methodology and way of determining HTBR in the conditions of forced strain was described in the papers [12, 14]. It has been found that the HTBR width after casting in equal to $363^{\circ}C$ (in the range from $174^{\circ}C$ to $537^{\circ}C$) (Fig. 7a), whereas after solution heat treatment and ageing its value is lower and equal to $321^{\circ}C$ (in the range from $216^{\circ}C$ to $537^{\circ}C$) (Fig. 7b). However, the strain rate and intensity also has an impact on the resistance of the alloy to hot cracking in forced strain conditions. The critical strain rate (CSS) is the highest for as-cast condition (0.65 1/s) and decreases to the value of 0.47 1/s after precipitation hardening [14]. Also, the critical strain intensity decreases with the heat treatment rate. In case of as-cast QE22 alloy, the CST is equal to 0.21 $1/^{\circ}C$, and after precipitation hardening it as small as 0.04 $1/^{\circ}C$ [14]. This means that the as-received alloy is the least susceptible to hot cracking, despite the wide HTBR.

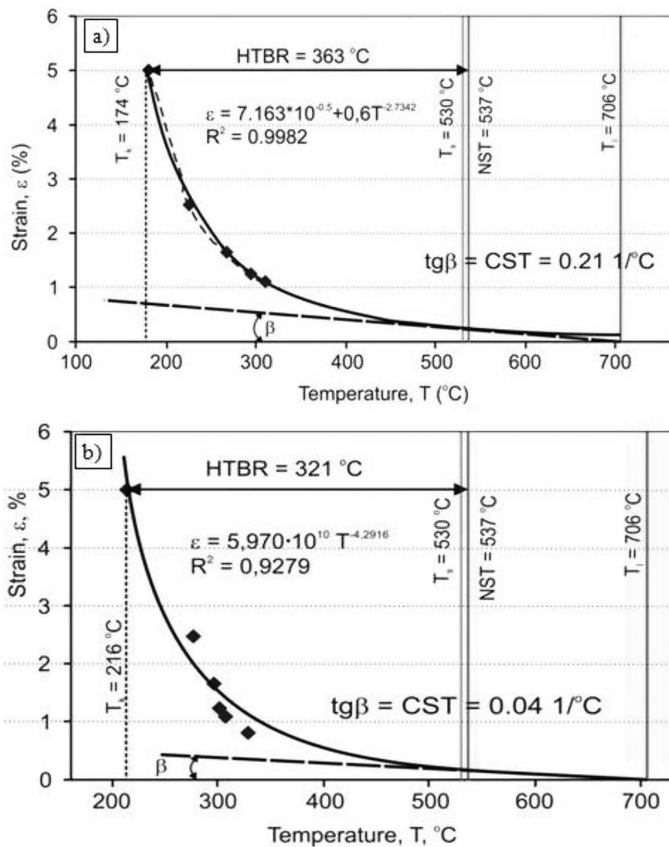

Fig. 7. Dependence of the strain on temperature function, determined in the Transvarestraint test: a) as-cast condition, b) solution heat treated and aged alloy

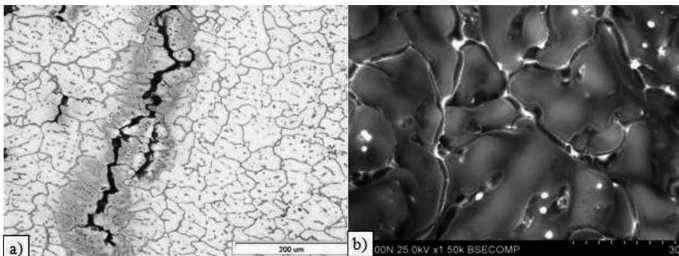

Fig. 8. Penetration microstructure after the Transvarestraint test: a) hot crack on the borders of weld dendrites, LM, b) fracture surface with a visible $(\text{Mg,Ag})_{12}\text{Nd}$ phase in the interdendritic areas, SEM

The metallographic analysis shows that hot cracks in the as-cast alloy propagate along the boundaries of the solid solution grains in the form of a network of cracks. Observations of the fracture surface on the fusion line also confirm the intercrystalline cracking both in the weld penetration area and in the native material. After solution heat treatment and ageing, the main crack develops as an interdendritic crack on the $\text{Mg}(\alpha)$ grain boundaries (Fig. 8a). Numerous small cracks were also observed in the strongly strained area, formed as a result of local partial melting of the $(\text{Mg,Ag})_{12}\text{Nd}$ phase and disruption of the intercrystalline liquid. On the fracture surface one could observe partially melted arms of the $\text{Mg}(\alpha)$ dendrites with crystallized $(\text{Mg,Ag})_{12}\text{Nd}$ phase in the interdendritic areas (Fig. 8b).

5. Impact of technological factors on the susceptibility to hot cracking of the QE22 alloy

Impact of technological factors on the susceptibility to hot cracking in the range of high temperature brittleness was performed on the basis of pad welding and welding tests with various values of the linear energy of the arc. The tests were performed with a Lincoln V 205 AC/DC inverter welding machine, with the alternating current and with the TIG method (141). This device is equipped with a system which enables one to increase the current intensity both during the arc ignition and extinction. Increase time of the current was set for 2s to a given value, and the arc extinction time was set for 4 s. A 3.2 mm infusible tungsten electrode was used, WT20 (according to EN 26848). Technical argon with a purity of 99.995 and flow of 10 l/min was used as the shielding gas. Free gas outlet was determined for 3 s at the start of the welding process and for 4 s at the end of the welding process.

Pad welding was performed on rectangular plates with $150 \times 70 \times 5$ mm dimensions. The plates were bilaterally beveled at an angle of 30° , with welding threshold of 2 mm, for the welding purposes. An additional material of chemical composition similar to the basic material in the form of 2.4 mm diameter bars was used for welding and pad welding. The technological parameters of pad welding and welding are summarized in Table 2. In order to calculate the linear energy of the arc, it was assumed that the heating efficiency η amounted to 0.60 [7].

Quality of the padding welds and of the welds was assessed by adopting the B criterion for aluminum alloys according to PN EN 30042:1998. The results are shown in Table 2. Sample photos of the macro and microstructure faces of the performed welds are shown in Fig. 9.

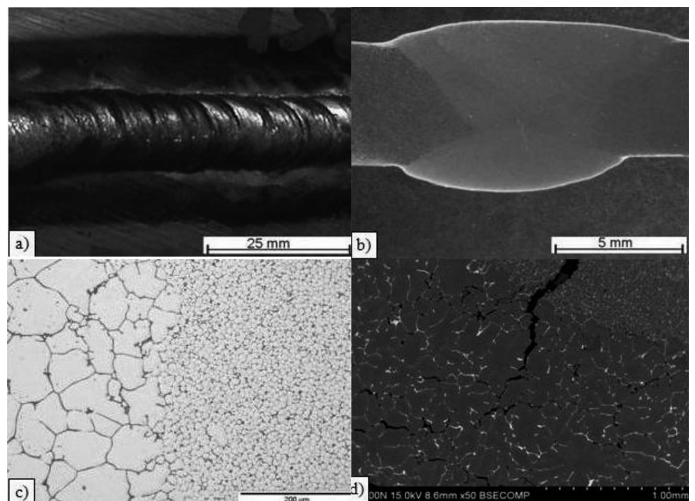

Fig. 9. QE22 alloy joint ($I = 120$ A, $El = 3.0$ kJ/cm): a) weld face, b) macrostructure of two-sided butt joint – correct joint condition, as-cast, c) refinement of microstructure in the weld fusion line, as-cast condition, LM d) hot crack in weld and network of cracks in HAZ, SEM

Tests on the QE22 alloy susceptibility to hot cracking during pad welding and welding indicate that this alloy is not easily weldable, especially while recasting without the addi-

TABLE 2

Technological parameters of pad welding and welding of the QE22 alloy and results of the visual assessment of the joints

Welding process of QE22 alloy	Heat treatment	Welding current [A]	Arc voltage [V]	Linear energy of the arc [kJ/cm]	Comments and results related to the assessment of the marking inconsistency according to PN EN 30042:1998
PAD WELDING PROCESS	as-cast	120	14	3.0	Irregular face
		130	15	3.5	-
		140	16	4.0	-
	solution heat treated and aged	120	14	3.0	Lack of inter-run fusion (401)
		130	15	3.5	-
		140	16	4.0	-
WELDING	as-cast	120	14	3.0	-
		140	16	4.0	-
	solution heat treated and aged	120	14	3.0	-
		140	16	4.0	Crack in the weld and HAZ (100)

tional material (Table 2). Hot cracks are formed in the weld and develop along the boundaries of the partially melted Mg(α) crystals in the areas of the interdendritic liquid (Fig. 9d). In the HAZ area the crack takes the form of a network of cracks localized in places of local melting of the (Mg,Ag)₁₂Nd phase (Fig. 9). The fracture surface with a network of (Mg,Ag)₁₂Nd phase in the interdendritic areas confirms this cracking mechanism. Pad welding or welding with an additional material with chemical composition similar to the base material, enables to achieve padding welds and welds with no welding imperfections (Fig. 9a,b).

It was found that heat treatment of the alloy increases its susceptibility to cracking, especially during pad welding (Table 2). Observations of the macrostructure of the butt joints confirm that a correct connection with full weld penetration has been achieved. (Fig. 9b). The weld also revealed substantial refinement of microstructure (Fig. 9c). It was found that the joints should be formed with the use of the linear energy of the arc not exceeding 3.0 kJ/cm, with string beads, with the additional material with chemical composition similar to the base material.

6. Technology of repairing QE22 alloy casts

On the basis of the test results described in chapters 3-5 it was found that the QE22 alloy casts should be repaired directly after casting. Samples presented in Fig. 10 were prepared on the basis of the requirements of PN EN 15614-4 for the purpose of qualifying the repair procedure. The pad welding and welding was performed with the TIG method, with the

use of alternating current in argon shield. Parameters of pad welding and welding are presented in Table 3. These tests simulate typical defects in the magnesium alloy casts. Lack of hot cracks was chosen as the criterion of the joint correctness. The formation of padding weld and weld was assessed by visual tests carried out according to PN-EN 970:1999 Ap1:2003 (VT), penetration tests according to PN-EN 571-1:1999 (PT) and X-ray tests according to PN-EN 1435:2001 (X-ray). Then fracture tests were carried out pursuant to the requirements of ISO 9017. Results of non-destructive tests and fracture tests of the frontal and lateral surface of the padding weld are presented in Table 3.

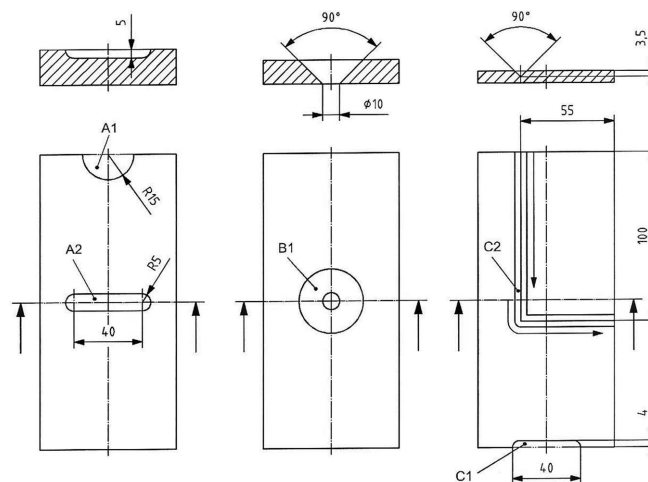
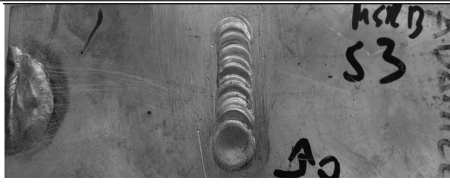



Fig. 10. Dimensions of samples used for padding and welding, simulating the typical casting defects, according to PN EN 15614-4

TABLE 3

Parameters of pad welding and welding of the QE22 alloy

Alloy	Process	Current intensity [A]	Arc voltage [V]	Welding speed [cm/min]	Gas volume stream [l/min]	Gas jet diameter [mm]
QE22	Pad welding	120	14	20	10	12
	Welding	120	14	20	10	12
Quality assessment results						
Samples after pad welding and welding				VT	PT	RT
QE22				positive	positive	positive
				positive	positive	positive
				positive	positive	positive

Assessment of the pad welding and welding operations showed that the developed technology of the QE22 alloy casts repairing is correct (Table 3). No hot cracks or welding imperfections (defects) were identified in the samples. These results are confirmed by non-destructive tests.

An experimental cast of a gear housing was designed and made in WSK ZM Rzeszów in order to verify the technology of QE22 magnesium alloy casts repairing (Fig. 11a,b). This cast was characterized by variable wall thickness and variable stiffening following the design recommendations. A defect in the form of a crack in the cast of 100 mm long and 3 mm wide was simulated. The crack ran through the stiffening and walls of various thickness. Analysis of the temperature fields, distributions of strain and stress during the simulated repair was carried out with use of the fine element. The analysis results were used for the joint preparation. The repair joint was prepared on the basis of “X” angle of bevel of 60° (Fig. 11c).

The repair was performed with the use of the TIG method, alternating current and with the use of the 3.2 mm tungsten electrode (WT20) and argon shield with flow of 10 l/min (Fig. 11d). The welding was performed on the basis of parameters described in Table 3. The QE22 alloy cast after repair is presented in Figures 11 e,f. Visual assessment of the repaired cast did not reveal any cracks, undercuts or other welding imperfections. The face of the weld was smooth and uniform (Fig. 11f). Penetration tests did not reveal any surface cracks, either. Macroscopic metallographic tests were performed in addition to non-destructive tests. It was found that the examined joints were correct and were characterized by a normal

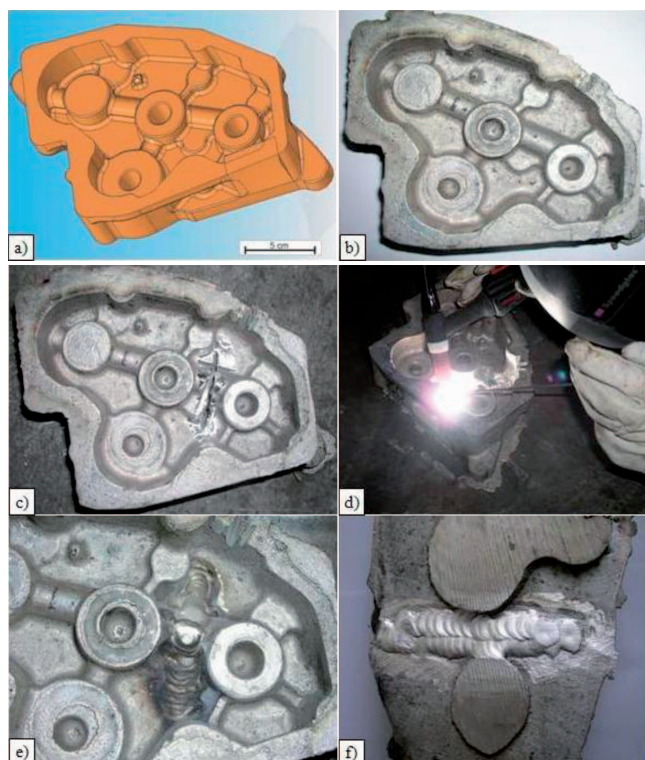

Fig. 11. Verification of the technology of repairing the QE22 alloy cast of the gear housing: a) cast model, b) experimental prototype made in ZM WSK Rzeszów, c) simulated welding defect in the form of a crack app. 100 mm long, d) cast repair welding and pad welding process, e) face of the weld of the casting, f) face of the weld outside on the casting

arrangement with a full weld penetration. No tungsten inclusions, lacks of inter-run fusion or cavities were revealed. The developed technology of pad welding and welding of the QE22 magnesium alloy casts guarantees proper repair and may be applied in industrial practice.

7. Conclusions

Test results presented in this paper confirm the thesis that weldability of the QE22 alloy depends on the susceptibility to hot cracking, which in turn depends on metallurgical, structural and technological factors. Metallurgical factors include the chemical composition and joint microstructure, the structural factors include the cast shape and its stiffness whereas the technological factors include the welding method, linear energy of the arc, having an impact on the thermal cycle, and heat treatment.

Hot cracking of QE22 alloy starts in the form of voids in the areas of the melted $[Mg(\alpha) + (Mg,Ag)_{12}Nd]$ eutectic mixture, and the loss of continuity results from separation of the solid solution crystals. A "healing" phenomenon, i.e. a process of casting the voids between the crystals with the residual liquid, can be observed in the alloy. HTBR for the alloy, regardless of the heat treatment, amounts to 35-45°C and the cracking resistance rate amounts to $0.37 \div 0.40$, therefore the alloy is resistant to hot cracking.

Strain of the tested alloy casts, specific for the pad welding and welding processes extends the range of high temperature brittleness by 321°C, compared to the range of high temperature brittleness determined in the simulation conditions with the use of the Gleeble device. The mathematically described ductility curves $\varepsilon = f(T)$ allow one to determine and to apply in practice the CSS and CST indexes in the assessment of the susceptibility of the QE22 alloy to hot cracking.

Casts characterized by constant stiffness should be classified readily weldable. Variable rigidity of the cast resulting e.g. from the varied wall thickness increases a susceptibility to hot cracking.

Limitation of the linear energy of the arc from 2.2 kJ/cm to 3.0 kJ/cm and application of a filler metal with chemical composition similar to the base material decreases the susceptibility to hot cracking. Repairs of magnesium alloy casts with welding technologies should be performed with the TIG method, alternating current in the argon shield with a flow of 10 l/min, with a filler metal with chemical composition similar

to the base material, and in particular the QE22 alloy should be repaired with welding technologies after casting with a current of 120 A at the voltage of 14 V. The joints must be heat treated after the welding - solution heat treatment 8h/525°C/air + ageing 16h/200°C/air (T6).

REFERENCES

- [1] Elektron MSR-B, Data sheet 463, Magnesium Elektron, Great Britain, 2006.
- [2] V. W e s l i n g, Effect of overageing temperature on the superplastic behaviour in magnesium alloys, *Materials Science and Engineering A* (2007).
- [3] H. B a k e r, Magnesium and Magnesium Alloys, *ASM Speciality Handbook*, USA, 1999.
- [4] A. R a k o w s k a, U. P o d o s e k, R. C i a c h, Some aspects of solidification and homogenisation of Mg-Ag alloys, *Materials and Design* **18**, 1997.
- [5] H.E. F r i e d r i c h, B.L. M o r d i k e, *Magnesium Technology: metallurgy, design, data, applications*, Springer-Verlag, Berlin Heidelberg, 2006.
- [6] J. A d a m i e c, S. R o s k o s z, R. J a r o s z, Repair of Magnesium Alloy Castings By Means of Welding and Pad Welding, *Journal of Achievements in Materials and Manufacturing Engineering* **22**, 1, 21-24 (2007).
- [7] J. A d a m i e c, Spawalność odlewniczych stopów magnezu [Weldability of Cast Magnesium Alloys], *Wyd. Pol. Śl.*, Gliwice 2010.
- [8] E. T a s a k, A. Z i e w i e c, Spawalność materiałów konstrukcyjnych, tom1 Spawalność stali [Construction materials weldability, vol 1, Steel weldability], *Wydawnictwo JAK*, 2009.
- [9] J. A d a m i e c, S. M u c h a, Determination Brittle Temperature Range of MSR-B Magnesium Alloy, *Archives of Metallurgy and Materials* **56**, 1, 109-119 (2011).
- [10] A. K i e ł b u s, T. R z y c h o Ń, The intermetallic phases in sand casting magnesium alloys for elevated temperature, *Materials Science Forum* **690**, 214-221 (2011).
- [11] J. A d a m i e c, Assessment of High-Temperature Brittleness Range of the Casted Alloy AZ91, *Materials Science Forum* **690**, 41-44 (2011).
- [12] J. A d a m i e c, The assessment of impact of construction factors on weldability of MSR-B alloy. *Materials Science Forum* **690**, 37-40 (2011).
- [13] A. K i e r z e k, J. A d a m i e c, Evaluation of susceptibility to hot cracking of magnesium alloy joints in variable stiffness condition, *Archives of Metallurgy and Materials* **56**, 3 (2011).
- [14] J. A d a m i e c, Weldability of the MSRB magnesium alloy, *Solid State Phenomena* **176**, 107-118 (2011).