

Testing the Acoustic Silencers

Marek PIERCHAŁA

KOMAG Institute of Mining Technology
Pszczynska 37, 44-101 Gliwice, Poland; e-mail: mpierchala@futurespace.pl

(received March 26, 2015; accepted October 26, 2016)

Problems associated with designing silencers are presented. Results of direct tests of silencers for cooperation with systems of axial fans, as well as results of numerical tests of a two stage acoustic silencer, are given. The numerical tests enabled determining the distribution of acoustic field inside the silencer and in the surrounding area. In those tests A sound insertion losses for different variants of installation inside the silencer, as well as for two different types of absorbing material used to fill the silencer walls, were determined. Impact of design features of silencers on effectiveness of noise reduction is described. Also, a technical sketch of a universal silencer with significant noise reduction ($D_{ipS} = 39.1$ dB) which can be successfully used in many ventilation systems is presented.

Keywords: silencers; aerodynamic noise; noise reduction; ventilation systems; numerical tests; acoustic field; sound absorbing cassettes; dispersing component.

1. Introduction

Silencers are typical devices used for reduction of noise in ventilation systems which can be found in almost all industrial installations, service and retail outlets, being sources of significant environmental noise and noise at workplaces (CROCKER, 2007; ENGEL, ZAWIESKA, 2010). Numerous scientific publications on recommendations for designing the reflection silencers are available (BIES *et al.*, 2009; CHANG *et al.*, 2010; DOWLING *et al.*, 2004). Problems of optimisation of multi chamber silencers are the subject of publication (CHANG *et al.*, 2010), in which algorithm enabling selection of design features of the silencer regarding its effectiveness of noise reduction, e.g. air compressors, has been formulated. The algorithm of broad scope of use in designing the reflection silencers, including specifically car silencers, is presented in (DOWLING *et al.*, 2004). Shorter time required to obtain the design solution of the silencer of wanted noise reduction level is its advantage over the current solutions. Acoustic tests of porous resonators used in the silencer chambers, where streams of sound are decompressed, are presented in (WANG, 1999). There are very few scientific publications on designing the industrial sound-absorbing silencers, especially those regarding designing the axial silencers and selection of materials for their construction, as well as their geometric features (KIRBY, 2001). In the industry, there is often a need for using design

solutions which would limit costs and time of production breakdowns required for building the noise reduction installations. That is why, in the case of axial fans system, the typical commercial solutions, searching for most efficient configurations of few silencers, are often used. No guidelines regarding the relative positions of silencers in ventilation systems have been found in the world literature. In the mining industry and in the heavy industry we can find the following configuration: silencer, fan, silencer (variant IV in Table 1). That is why it is necessary to check which arrangement of silencers is most wanted. Designing of multistage sound absorbing silencers, as well as simultaneous identification of acoustic field inside the silencer and around it, is the next problem in technical acoustics. It is indispensable to verify impact of design features on the silencers' effectiveness. Boundary Element Method (LOUA *et al.*, 2003) was successfully used in testing the slot silencers, but only in the case of simple designs. Tests of single sound-absorbing inserts are presented in (CUMMINGS *et al.*, 1996). Tests of silencers with spiral turn inserts (ŁAPKA, 2007; 2009) seem to be very interesting. The tests image the distribution of acoustic field inside the silencer.

Designing the silencers and other anti noise protection devices requires consideration of number of physical phenomena and factors associated with propagation of acoustic waves (AUGUSTYŃSKA *et al.*, 2000; KLEKOT, 2012). The level of air flow resistance is

an important parameter in designing the silencers (PIERCHAŁA, 2011). Not properly designed silencers have a negative impact on operation of fans' system, leading to increase of electric power consumption, overheating of motor winding and even its damage (PIERCHAŁA, 2011). Thus, both laboratory and numerical tests are necessary in a designing process (AUGUSTYŃSKA *et al.*, 2000; GOŁAŚ, 1995; KUTRUFF, 1991). Obtaining the required noise reduction, at low costs of manufacture of a single protecting unit, is a problem in designing the protection systems. It was estimated that about 30% of all anti noise protections do not meet their basic function, providing insufficient protection against overstandard noise. Thus, it was necessary to carry out the tests of silencers, in order to determine the impact of the selected design features of anti noise protections on the level of noise reduction.

2. Direct tests of silencers

The silencer is presented in Fig. 1. It is used to reduce noise in ventilation systems with axial fans. These systems are one of most frequently used ventilation systems. Silencers of such type are designed with a diameter bigger or equal to the diameter of the fan (or ventilation duct). One silencer in front of the fan and one silencer behind the fan have been used in industrial conditions so far.

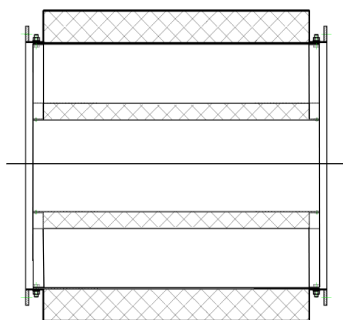

Fig. 1. Cross-section of acoustic silencer with the dispersing component.

Verification of previous approach to designing and use of silencers as well as determination of most wanted features of the silencers, which have the greatest impact on effectiveness of noise reduction, are the objectives of the tests. The silencer in question belongs to a group of absorptive silencers, which use the phenomenon of absorption of energy of acoustic waves by sound absorbing material used to fill the silencer's coat. The silencer's bearing structure is made of welded steel sheets ensuring its rigidity.

Perforated metal sheets, described in Sec. 5, are used inside the silencer, where there is a contact with air stream. Detailed technical design of ten variants of silencers, based on a general concept of the silencer described above, was developed to meet the assumed objective. Schematic diagrams of silencers for each variant are presented in Table 1. Then the silencers were manufactured in a specialised factory. Different variants of silencers' arrangement are described below.

Variant I with a silencer of nominal diameter \varnothing 630 mm and length 850 mm, filled with absorbing material having the reverberant sound absorption coefficient α_w equal to 0.85, was the basic tested arrangement. Two silencers adjacent to each other were used in variant II, while two silencers connected by flexible ventube were used in variant III (angle between axes of acoustic silencers was equal to 150°). In variant IV one silencer was placed in front of the fan, while another one was placed behind the fan. Variants V–X include diffusers and converging cones, which are often found in real ventilation systems. Additionally, a component dispersing acoustic waves, in a form of ring shaped sound absorbing cassette, was used in acoustic silencer in variants VII, IX, and X.

A cross-section of acoustic silencer with a component dispersing acoustic waves, tested in variants VII, IX, and X, is presented in Fig. 1. In variants VII and IX this silencer was connected to the diffuser, while in variant X it was connected to the diffuser and converging cone.

Direct tests covered the measurements of A sound level with use of standard sound level meter of class 1.

Table 1. Results of direct tests – A sound insertion loss – D_{ipS} .

	Variant I	Variant II	Variant III	Variant IV	Variant V
D_{ipS} [dB]	12.1	19.6	18.3	10.8	14.8
	Variant VI	Variant VII	Variant VIII	Variant IX	Variant X
D_{ipS} [dB]	15.5	15.1	10.8	15.9	16.3

The measurements were taken in the laboratory of the KOMAG Institute of Mining Technology. The prototypes of acoustic silencers for use in the systems of axial fans were the testing objects. The tests were carried out in three measuring series and their results were averaged. The measurements were taken at low acoustic background, with 11 dB gap between measured A sound level and acoustic background. A two axial (counter rotating) mine fan of WLE type and diameter \varnothing 630 mm was the source of noise. It was placed centrally in a tested room of dimensions 18×42 m and height 8 m. The temperature in the room was equal to 21°C and humidity was equal to 50%. Expanded uncertainty of the results of measurement of the sound level with the confidence level of 95% was equal to 1.3 dB.

The results of the acoustic silencer tests are given in Table 1, presenting A sound insertion loss (PN-EN ISO 11820:2000), for ten tested arrangements of the silencers.

The highest A sound insertion loss was recorded for the system of acoustic silencers tested in variant II and it was 19.6 dB, while use of flexible ventube for connection of silencers reduced this difference to 18.3 dB. Disturbance of airflow, causing additional turbulences generating acoustic waves, is the reason of this phenomenon. One of the lowest A sound insertion losses was recorded for two silencers placed in front of and behind the fan and for the silencer with installed converging cone – 10.8 dB for both tested variants. The silencer with a dispersing component (Fig. 1) is an option for a simple acoustic silencer (variant I). It was indispensable to increase the silencer's diameter to limit the flow resistance inside. Thus, it was necessary to use the diffuser. This is the reason why the silencer as an independent device without a diffuser or converging cone was avoided in the tests. A sound insertion loss for the analysed variant was equal to 15.9 dB. Thus, it is recommended to use this solution in the cases when the use of double silencers from variant II is impossible due to technical reasons or there is a demand for reducing the investment costs. As the tests in variant III were carried out for the strictly defined single position of the silencers axle, it was decided to extend the tests to determine the impact of change of the angle on the level of the emitted sound. The tests were carried out for four combinations of position of silencers against each other, as in Fig. 2 and Table 2. The silences were connected by a flexible ventube.

The highest A sound insertion loss was obtained for combination III/1 and it was equal to 18.9 dB. However, it was smaller than in a variant where the silencers were adjacent to each other ($D_{ipS} = 19.6$ dB). This is caused by the fact that increase of the area of absorption of acoustic waves' energy reduces the range of frequency for which reduction of waves energy is observed, which has an impact on a higher effectiveness of the silencer's operation. The use of a flexible ventube

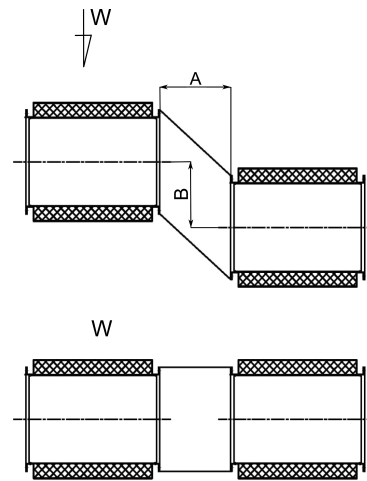

Fig. 2. Connection of two simple silencers with diameters \varnothing 630 mm by a flexible ventube.

Table 2. A sound insertion loss – D_{ipS} .

Combination	Dimension A in Fig. 2 [mm]	Dimension B in Fig. 2 [mm]	D_{ipS} [dB]
III/1	92	0	18.9
III/2	80	16	17.9
III/3	65	28	17.6
III/4	23	22	16.3

decreases this area, which reduces damping effectiveness. In the case of other variants, as it was earlier observed, an increase of turbulences in the air streams flow causes generation of additional micro sources generating acoustic waves. Thus, D_{ipS} decreases with the increase of relative dislocation of acoustic silencers as in Fig. 2 (upper case).

Installation of the silencers used in variant II of the tests for reduction of environmental noise generated by dust control system in a building for mechanical processing of coal is presented in Fig. 3.



Fig. 3. Example of implementation of variant II of acoustic silencers to the industry (PIERCHALA *et al.*, 2010).

3. Numerical tests of the silencer

Acoustic tests and analyses of different ventilation systems carried out by the author point to the necessity of development of a concept of a new acoustic silencer with A sound insertion loss exceeding 25 dB. It is planned to install this silencer on the roofs of industrial objects. It was assumed that it should have a simple design and low operational requirements. Considering the above requirements, initial design of the silencer was developed and it is presented in the form of a draft in Fig. 4. The design of the silencer was developed taking into account the experience gained in designing and tests of such type of anti-noise protection systems. However, determination of silencer's effectiveness without building the expensive prototype and carrying out the tests became a problem. This problem was solved by use of numerical methods enabling identification of the acoustic field inside the tested silencer, which at the same time allows identifying the acoustic field in the environment surrounding the tested silencer. Verification of the silencer design as regards its differentiation in noise reduction, depending on the arrangement of sound absorbing cassettes, was required – Fig. 4 item 3 and 5.

Sound absorbing cassettes (3 and 5) in Fig. 4 were made according to the technology presented in Fig. 5. The cassette consists of supporting profiles (1), which

can be closed or open ones, e.g. in the shape of letter C; external perforated metal sheets (2), which increase the structure rigidity; and of the filling material – most often this is a sound absorbing material (3). The perforated metal sheets are fixed to the supporting profiles with blind rivets. It is recommended to install an additional diaphragm made of 0.50 mm or 0.75 mm thick steel sheet in the axis of the sound absorbing cassette to increase its acoustic insulation (4).

The numerical tests of the silencer presented in Fig. 4 were carried out using the methods for geometrical determination of the sound level, including, inter alia, the Ray Tracing Method – RTM. The acoustic field around the silencer and sound levels in the observation points were calculated using the recommendations of PN-ISO 9613-2:2002 Standard. The acoustic field inside the silencer was calculated using the recommendations of VDI 3760:1996-02 standard. The tests were carried out in the following standard conditions: relative humidity 70%, ambient temperature 10°C, air pressure 1013.3 mbar. The geometric features of the silencer design were recreated in the numerical model on the basis of design documentation keeping accuracy of dimensions (with errors up to 10 mm), neglecting the rounds of edges. The real source of sound was recreated in the silencer by the point source of even emission of the acoustic wave energy in all directions. This source was placed in an

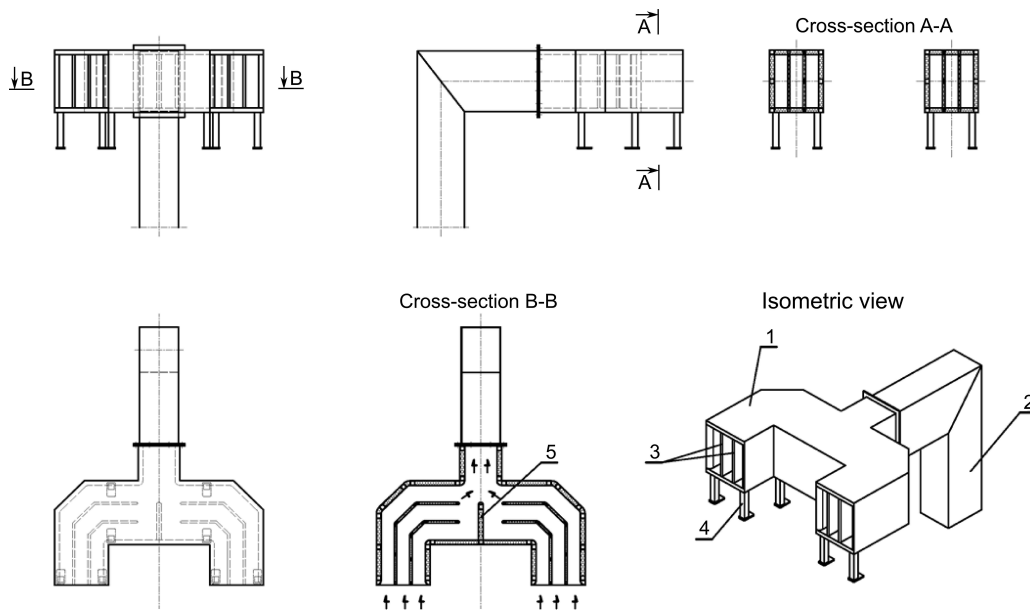

Fig. 4. Design of the tested acoustic silencer.

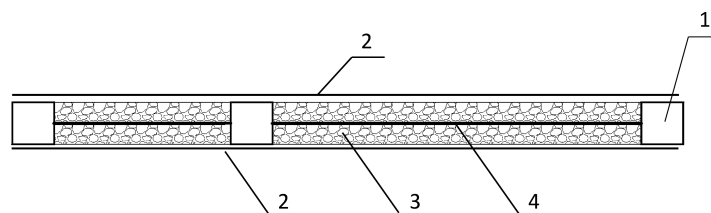

Fig. 5. Recommended design of the sound absorbing cassette.

axis of the silencer's inlet channel. The acoustic power for each octave band within the range from 31 Hz to 16 kHz, calculated according to PN-EN ISO 3746:2011 standard on the basis of A sound level, was the parameter describing the numerical source of sound. A sound level for each of the above octave bands comes from previously taken industrial measurements for the ventilation system for which $L_{Aeq} = 102.5$ dB. The result of this measurement is presented graphically in Fig. 6.

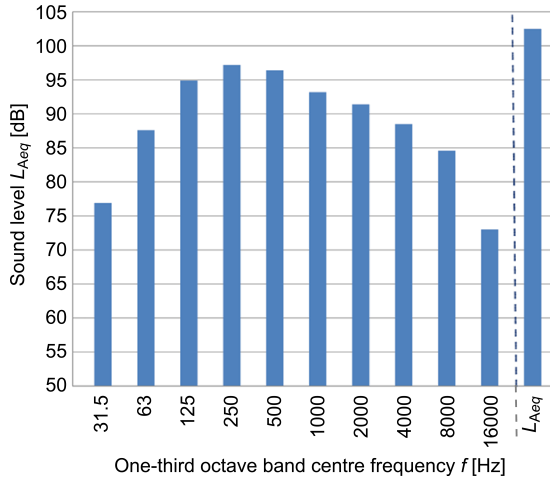

Fig. 6. Structure of the frequency spectrum of the sound emitted by the source of sound.

A sound level was calculated in the numerical tests for two measuring points Pp1 and Pp2 – the receivers, for which privilege direction of receiving acoustic waves was not defined in the numerical model. The measuring point Pp1 was located in the axle of the left outlet of the silencer at the distance of 1.0 m from the silencer's edge, while point Pp2 was located in the axle of the right outlet of the silencer at the distance of 1.0 m from the silencer's edge. Moreover, distribution of the acoustic field was calculated in the entire tested area, including the silencer's surroundings. During the development of the numerical model, it was assumed that in the silencer area, there are no additional objects reflecting acoustic waves, and that drop of the sound level behind the silencer outlet is the same as in a free field. The numerical calculations were made with the accepted error tolerance equal to 0.5 dB. Position vectors were neglected in further calculations after 3 reflections of the acoustic wave. Calculations of the acoustic field were made in nodes of meshing with the dimension of 10×10 cm with interpolation of results in so called field cells. Accuracy of results' interpolations was controlled, inter alia, by assumption that difference between the calculated and interpolated values should not exceed 0.15 dB.

Two types of absorbing materials of mineral wool type, filling the silencer, were used. The materials had different reverberant sound absorption coefficient α_w ,

which was equal to 0.85 for material X (B absorption class) and 0.95 for material Y (A absorption class). In the numerical model, the materials X and Y were defined by reverberant sound absorption coefficient in octave bands within the range from 125 Hz to 4 kHz, according to Tables 3 and 4.

Table 3. Material X – reverberant sound absorption coefficient in octave bands.

f	125 Hz	250 Hz	500 Hz	1 kHz	2 kHz	4 kHz
α_p	0.200	0.550	0.950	0.950	0.850	0.750

Table 4. Material Y – reverberant sound absorption coefficient in octave bands.

f	125 Hz	250 Hz	500 Hz	1 kHz	2 kHz	4 kHz
α_p	0.700	1.000	1.000	0.950	0.900	0.900

Numerical calculations were made for six variants, assuming that external dimensions of the silencer are not changed. Impact of sound absorbing cassettes (shown in Fig. 4 – numbers 3 and 5) installed in a silencer and change in the material filling them on A sound level in the silencer and its surrounding was tested. The sound absorbing cassettes are additional elements in the silencers. They absorb energy of acoustic waves. In the tests, the cassettes absorbing the sound energy from both sides, which are made of carrying profiles with mineral wool protected by perforated metal sheets, were used. The filling material X was used for variants I–V of calculations, while the filling material Y was used in variant VI.

3.1. Variant I of calculations

The silencer without installed sound absorbing cassettes, filled with material X ($\alpha_w = 0.85$), was assumed for the numerical calculations. Distribution of the acoustic field, both in the silencer and beyond it, is presented in Fig. 7. The analysis of this field distribution enables concluding that significant part of energy of acoustic waves is reduced in the area, where the direction of the air stream flow is changed for the first time (from the moment of the air inflow to the silencer – the first degree of the silencer). No such significant changes in sound levels are observed further. As a result, we can conclude that lack of sound absorbing cassettes creates a negative impact of noise on the surrounding environment.

A sound levels calculated for measuring points Pp1 and Pp2 are presented in Table 5.

Table 5. A sound level in measuring points for variant I of calculations.

	Point Pp1	Point Pp2
Sound level L_{Aeq} [dB]	77.9 ± 2.5	77.9 ± 2.5

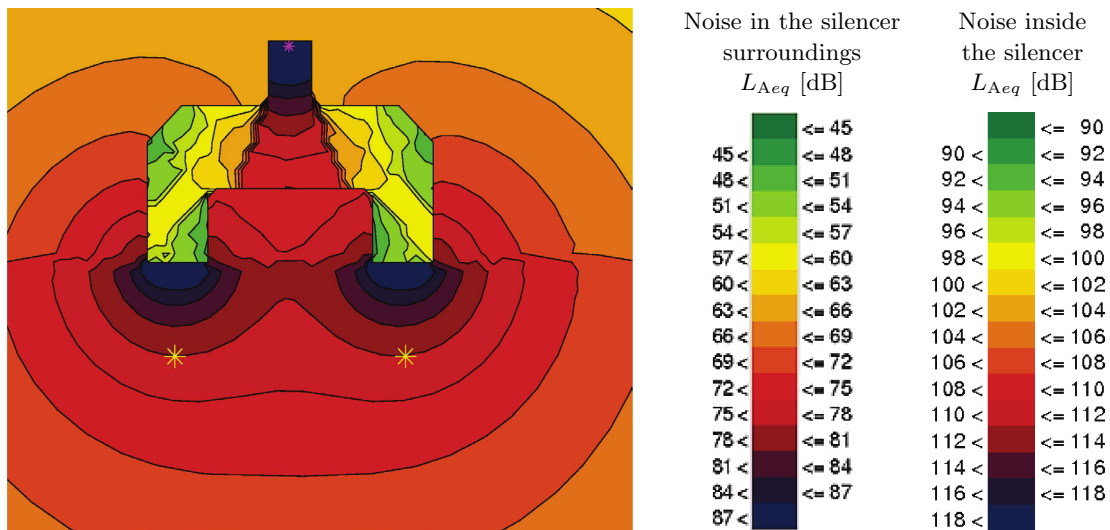

Fig. 7. Acoustic field distribution in the silencer and its surroundings – variant I of calculations.

A sound insertion loss, $D_{ipS} = 24.6 \pm 2.5$ dB, was calculated on the basis of numerical tests.

The results of the numerical calculations for variant IV, which is representative as regards damping effectiveness, are presented in Fig. 9 and in Table 6. The results of the calculations for other variants, i.e. variant II, III, V, and VI, are given in Table 7.

3.2. Variant IV of calculations

Silencer with four installed sound absorbing cassettes, arranged as it is shown in Fig. 8, was used for the numerical calculations. The place where the source of sound is located as well as inlets of air streams are indicated. The silencer in Fig. 8 is filled with sound absorbing material X ($\alpha_w = 0.85$).

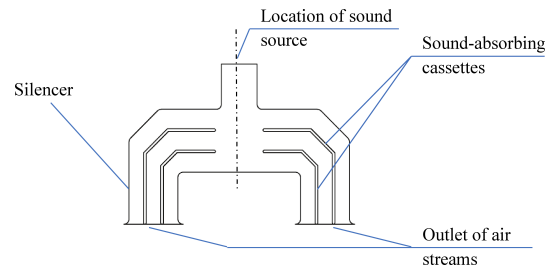

Fig. 8. Scheme presenting installation of the silencer for variant IV of calculations.

Acoustic field distribution in the silencer and around it is presented in Fig. 9. When comparing the distribution form Fig. 7 and Fig. 9, significant differences in A sound levels can be found.

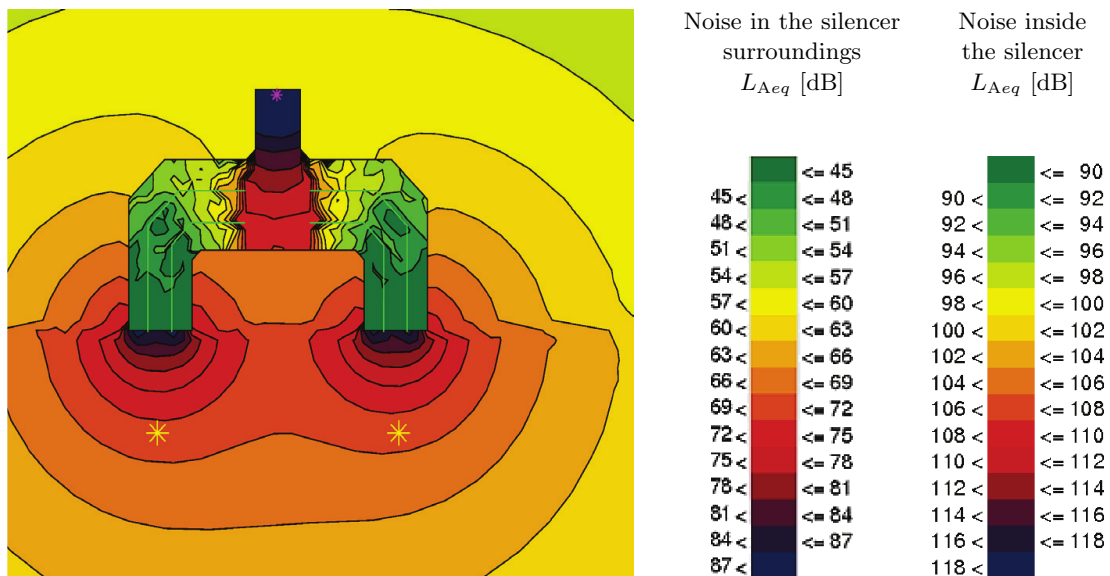

Fig. 9. Acoustic field distribution in the silencer and its surroundings – variant IV of calculations.

Installation of sound absorbing cassettes inside the silencer enabled a significant drop of *A* sound level also in the second cross section (second degree of the silencer), in which direction of the air stream flow is changed. In this solution, efficiency of the silencer is significantly increased, while *A* sound insertion loss was equal to $D_{ipS} = 31.6$ dB for Pp1 and $D_{ipS} = 32.2$ dB for Pp2.

A sound level for the measuring points Pp1 and Pp2 is presented in Table 6. The levels are lower than those that were calculated for the silencer without sound absorbing cassettes by more than 7 dB. Taking into account the low cost of the cassettes' manufacture and their effectiveness it is recommended to use them in almost every case.

Table 6. *A* sound level in the measuring points for variant IV of calculations.

	Point Pp1	Point Pp2
Sound level L_{Aeq} [dB]	70.9 ± 2.5	70.3 ± 2.5

A sound insertion loss $D_{ipS_{MAX}} = 32.2 \pm 2.5$ dB, was calculated in numerical tests.

4. Analysis of the numerical test results

The analysis was made on the basis of the results included in Table 7 and the acoustic field distribution for each variant of calculations. It was found, as it was expected, that the silencer tested in variant I of calculations has the lowest effectiveness. The highest reduction of energy of acoustic waves took place in the first degree of the silencer, and no significant changes of sound levels were observed further on. The silencer tested within variant VI of calculations, filled with material Y of reverberant sound absorption coefficient $\alpha_w = 0.95$, has the highest effectiveness of noise reduction. For this solution *A* sound insertion loss was

Table 7. Results of the numerical tests for different variants.

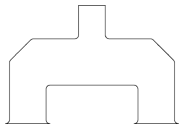
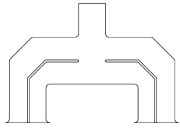
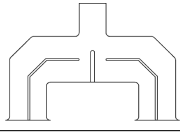
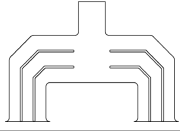
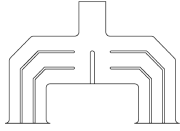
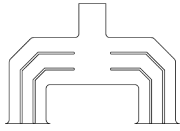
Variant I of calculations	
	<i>A</i> sound insertion loss Pp1: $D_{ipS} = 24.6$ dB Pp2: $D_{ipS} = 24.6$ dB
Variant II of calculations	
	<i>A</i> sound insertion loss Pp1: $D_{ipS} = 29.8$ dB Pp2: $D_{ipS} = 27.7$ dB
Variant III of calculations	
	<i>A</i> sound insertion loss Pp1: $D_{ipS} = 30.0$ dB Pp2: $D_{ipS} = 28.4$ dB
Variant IV of calculations	
	<i>A</i> sound insertion loss Pp1: $D_{ipS} = 31.6$ dB Pp2: $D_{ipS} = 32.2$ dB
Variant V of calculations	
	<i>A</i> sound insertion loss Pp1: $D_{ipS} = 31.5$ dB Pp2: $D_{ipS} = 32.1$ dB
Variant VI of calculations	
	<i>A</i> sound insertion loss Pp1: $D_{ipS} = 39.3$ dB Pp2: $D_{ipS} = 39.1$ dB

equal to 39.3 ± 2.5 dB – acoustic field distribution is presented in Fig. 10.

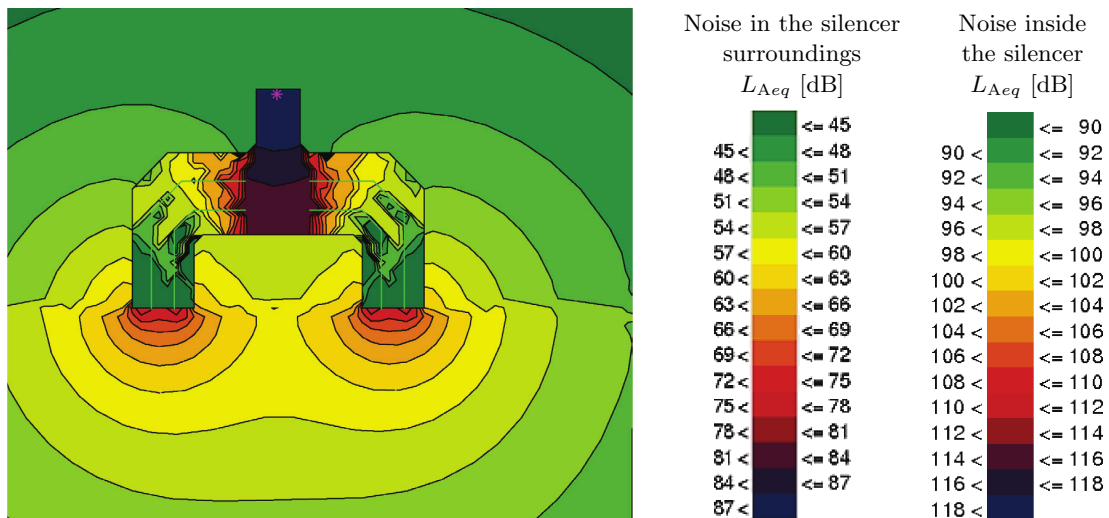

Fig. 10. Acoustic field distribution in the silencer and its surroundings – variant IV of calculations.

Significant changes of A sound level both in the range of the first and second stages of the tested silencer in the acoustic field distribution can be seen in Fig. 10. In the results of reflections of acoustic waves from the material with a high coefficient α_w a significant part of waves' energy is absorbed. It contributes to reduction of A sound level outside the silencer area.

Regarding the level of noise reduction, calculations for variants IV and V are interesting. They are of similar effectiveness of noise reduction, in the range of approximation error in numerical tests. The silencer from variant V of calculations differs from the silencer from variant IV only in an additional sound absorbing cassette, placed in the area of the first degree of silencer. Due to the fact that this cassette hampers significantly resistance of air flow through the silencer, and it does not increase significantly the effectiveness of the silencer operation, it is recommended to use the silencer as in variant IV of calculations. Regarding the approximation error in the numerical tests, similar results were obtained in tests for variants II and III. In both variants of the silencer design one row of sound absorbing cassettes was used. However, in variant III an additional sound absorbing cassette was used for division of air streams within the first degree of the tested silencer. The silencer tested in variant II has a significant effectiveness at low flow resistance. Thus, such a solution of the silencer is recommended for the systems in which flow resistance is especially important.

In Table 7 for variant I identical D_{ipS} for points Pp1 and Pp2, i.e. 24.6 dB, was obtained. For the rest calculation variants the results for points Pp1 and Pp2 are different. Asymmetry of the cassettes arrangement inside the silencers is the reason, despite the fact that differences in dimensions between design assumptions and the numerical model do not exceed 10 mm. Differences in dimensions result, inter alia, from limitations of the used software and model transformation errors.

5. General recommendations for designing the silencers

In the process of designing the acoustic silencers, special attention should be paid not only to the materials filling the silencer, but also to the protecting materials and their perforations (density of holes, position of holes against one another, and similar parameters). On the basis of the gained experience it is recommended to use perforated metal sheets with the following parameters:

- holes: $\varnothing 10$ mm,
- pitch: 12 mm,
- opposite scale: 10.3923 mm,
- angular shift: 60° .

The above described parameters of perforation were determined experimentally by testing the silencer D_{ipS} , presented in Table 1 – variant I, using a perforated metal sheet with different shape of holes – round and elongated ones – and their different arrangement.

The above description of the parameters is graphically presented in Fig. 11. Such selected perforation parameters ensure proper rigidity of metal sheets, limiting the surface of reflections of acoustic waves, which is beneficial for ensuring the highest possible effectiveness of reducing the noise by the silencer. Perforated metal sheets with thickness from 0.75 to 1.50 mm are most often used in the manufacture of silencers. The thickness of the used perforated metal sheet depends on the required sheet stiffness, which in turn depends on the pressure of the air stream flowing through a silencer. The thickness of the used perforated metal sheet may also depend on the environment in which the silencer operates – e.g., corrosiveness of the surrounding atmosphere. For silencers which operate in sewage treatment plant in acidic atmosphere, metal sheets with a minimum 1.50 mm thickness should be used.

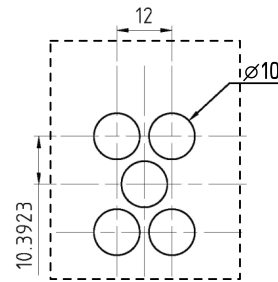

Fig. 11. Recommended parameters for perforated sheets in acoustic silencers – openings arrangement.

Designers of anti-noise protections should aim at obtaining effectiveness of noise reduction higher than that required for a given protection. It results from the fact that numerical models are prone to error, resulting from approximation, up to 2.5 dB. Due to the fact that anti-noise protections partly lose their effectiveness with time, standards of protection against noise can be exceeded. Here follow the factors that have impact on loss of effectiveness of anti-noise protections:

- wetting the filling materials,
- degradation of the filling materials (e.g. by substantial dust ingress),
- formation of acoustic bridges due to changes in the material density,
- change in spectrum of sound emitted by the suppressed source of noise as a result of change in the technical conditions.

According to our experience in using the anti-noise protections, it can be reported that after five years of their operation, effectiveness of noise reduction decreases by 2–5 dB, depending, inter alia, on operational conditions.

6. Summary

Silencers have been found to be a proper protection against over standard noise of ventilation systems, which negatively impact the surrounding environment. Designing the silencers should be preceded by laboratory tests of prototypes and by numerical tests. It should be noted that the tests are encumbered with uncertainty of results, which should be taken into account during the designing process. During the conceptual work, special attention should be paid to the problem of ensuring a low resistance of airflow. Loss of effectiveness of acoustic silencers in noise reduction in time, depending on operational conditions, should also be taken into account. Using the acoustic silencers in ventilation system of high output, we often have to force change in the airflow direction. However, rapid changes of direction of airflow often lead to disturbances (turbulent flow) and appearance of new micro sources generating acoustic waves. These sources limit effectiveness of noise reduction by the silencer. However, it is advantageous to adapt the length of silencer to the length of acoustic wave, for dominant frequency of sound emitted by a ventilation system. Use of filling material of higher reverberant sound absorption coefficient is a better solution in designing the acoustic silencers than introduction of additional flow resistance by designing further degrees of the silencer or installation of additional sound absorbing cassettes.

References

1. AUGUSTYŃSKA D. *et al.* (2000), *Evaluation of noise emission of machines* [in Polish: *Ocena emisji hałasu maszyn*], CIOP, Warszawa.
2. BIES D.A., HANSEN C.H. (2009), *Engineering noise control. Theory and practice*, Spon Press, London – New York.
3. CHANG Y.C., MIN-CHIE CHIU M.C. (2010), *Optimization of multi-chamber mufflers with reverse-flow ducts by algorithm of simulated annealing*, Archives of Acoustics, **35**, 1, 13–33.
4. CROCKER M.J. (2007), *Handbook of noise and vibration control*, John Wiley & Sons Inc., New Jersey.
5. CUMMINGS A., ASTLEY R.J. (1996), *Finite element computation of attenuation in bar-silencers and comparison with measured data*, Journal of Sound and Vibration, **199**, 3, 351–369.
6. DOWLING J.F., PEAT K.S. (2004), *An algorithm for the efficient acoustic analysis of silencers of any general geometry*, Applied Acoustics, **65**, 211–227.
7. ENGEL Z., ZAWIESKA W. (2010), *Noise and vibrations in work processes* [in Polish: *Hałas i drgania w procesach pracy*], CIOP-PIB, Warszawa.
8. GOŁAŚ A. (1995), *Computer methods in interior and environment acoustics* [in Polish: *Metody komputerowe w akustyce wnętrza i środowisku*], AGH, Kraków.
9. KIRBY R. (2001), *Simplified techniques for predicting the transmission loss of a circular dissipative silencer*, Journal of Sound and Vibration, **243**, 3, 403–426.
10. KLEKOT G. (2012), *Application of vibroacoustic energy propagation measures to monitor the condition of objects and as a tool in noise management* [in Polish: *Zastosowanie miar propagacji energii wibroakustycznej do monitorowania stanu obiektów oraz jako narzędzie w zarządzaniu hałasem*], WNITE-PIB, Radom.
11. KUTTRUFF H. (1991), *Room acoustic*, Elsevier Science Publishers, Barking, New York.
12. LOUA G., WUA T.W., CHENG C.Y. (2003), *Boundary element analysis of packed silencers with a substructuring technique*, Engineering Analysis with Boundary Elements, **27**, 643–653.
13. ŁAPKA G. (2009), *Acoustic attenuation performance of a round silencer with the spiral duct at the inlet*, Archives of Acoustics, **32**, 4, 247–252.
14. ŁAPKA G. (2009), *Insertion loss of spiral ducts – measurements and computations*, Archives of Acoustics, **34**, 4, 537–545.
15. PIERCHAŁA M. (2011), *A low-emission acoustic ventilation system of strategic importance* [in Polish: *Niskoemisyjny akustycznie system wentylacji obiektów o znaczeniu strategicznym*], Maszyny Górnicze, 1, 44–47.
16. PN-EN ISO 11820:2000: *Acoustics – Measurement of noise attenuators at the place of installation* [in Polish: *Akustyka – Pomiar tłumików hałasu w miejscu zainstalowania*].
17. PN-ISO 9613-2:2002: *Acoustics – Sound attenuation during propagation in the open space. General method of calculation* [in Polish: *Akustyka – Tłumienie dźwięku podczas propagacji w przestrzeni otwartej. Ogólna metoda obliczania*].
18. VDI 3760:1996-02: *Computation and measurement of sound propagation in workrooms*.
19. WANG C.N. (1999), *Numerical decoupling analysis of a resonator with absorbent material*, Applied Acoustics, **58**, 109–122.