

P. BRZIAK*, M. ŁOMOZIK**, R. MIZUNO***, F. MATSUDA****

REPAIR WELDING OF SQV2A PRESSURE VESSEL STEEL BY TEMPER BEAD TECHNIQUES WITHOUT POST WELDING HEAT TREATMENT

SPAWANIE REMONTOWE STALI SQV2A NA ZBIORNIKI CIŚNIENIOWE Z UŻYCIEM TECHNIKI ŚCIEGÓW ODPUSZCZAJĄCYCH BEZ OBRÓBKI CIEPLNEJ ZŁĄCZA PO SPAWANIU

SQV2A Manganese-Molybdenum-Nickel ferritic steel has been developed for pressure vessel fabrication. Due to its chemical composition and carefully controlled heat treatment the SQV2A steel consists of fine-grained tempered martensite/lower bainite microstructure, which exhibits well-balanced combination of strength and low temperature toughness. However, this balance is disturbed by the thermal cycles experienced during welding, producing areas of unaccepted mechanical behaviors. Generally, a decrease in toughness of some regions of BM Heat Affected Zone is the most critical aspect of multi-layer (repair) welding. A full scale Post Welding Heat Treatment (PWHT) usually restores the mechanical behaviors to requested levels. Additionally, PWHT removes hydrogen trapped in the microstructure during welding. A situation becomes critical, when on-site local (repair) welding takes place. Harsh environment, difficult access and a presence other facilities make the in-situ PWHT almost inapplicable. In term of cold cracking prevention, a Gas Tungsten arc Welding (GTAW) gives acceptable hydrogen levels in the weld region; and full scale PWHT is unnecessary. This is the main reason why the GTAW has become a leading process for on-site (repair) welding of heavy section components. Moreover, a automatic GTAW process offers better weld geometry controlling which has become out of importance for welding not followed by PWHT. A precisely controlled multiple weld thermal cycles of predefined peak temperatures in particular weld regions can be employed for restoring the mechanical behavior of critical weld areas instead of full scale PWHT.

Keywords: thermal welding cycle, HAZ, heat treatment, temper bead welding

Manganowo – molibdenowo – niklowa ferrytyczna stal w gatunku SQV2A została opracowana do wytwarzania zbiorników ciśnieniowych w przemyśle energetycznym. Dzięki składowi chemicznemu oraz kontrolowanej obróbce cieplnej mikrostruktura stali SQV2A składa się z drobnoziarnistego odpuszczonego martenzytu / dolnego bainitu, która wykazuje dobre połączenie właściwości wytrzymałościowych i ciągliwości przy niskich temperaturach. Jednakże te dobre zależności pomiędzy właściwościami wytrzymałościowymi a ciągliwością zostają zakłócone przez cykle cieplne, które oddziałują podczas spawania i prowadzą do powstania w złączu spawanym obszarów o niekorzystnych właściwościach mechanicznych. Obniżenie właściwości plastycznych (ciągliwości) niektórych obszarów SWC spawanej stali stanowi najbardziej krytyczny aspekt wielowarstwowego spawania remontowego. Typowa obróbka cieplna złącza spawanego po spawaniu PWHT zwykle przywraca właściwości mechaniczne do wymaganego poziomu. Ponadto obróbka cieplna PWHT złącza spawanego powoduje usunięcie z mikrostruktury wodoru uwięzionego podczas procesu spawania. Sytuacja bardzo komplikuje się w przypadku konieczności spawania remontowego na ograniczonym obszarze na dużym elemencie. Trudne warunki otoczenia, ograniczony dostęp do miejsca naprawy oraz obecność innych niedogodności sprawiają, że poprawne przeprowadzenie obróbki cieplnej złącza po spawaniu PWHT staje się bardzo utrudnione. W warunkach zapobiegania pęknięciom zimnym, spawanie metodą TIG (GTAW) daje zadawalająco niskie ilości wodoru w obszarach złącza a obróbka cieplna po spawaniu, w pełnym zakresie, nie jest wymagana. To stanowi główną przyczynę dlaczego metoda spawania TIG jest najczęściej stosowanym sposobem lokalnego spawania remontowego dużych elementów konstrukcyjnych. Ponadto, automatyczne spawanie metodą TIG umożliwia lepszą kontrolę geometrii spawanego złącza zwłaszcza w przypadku kiedy obróbka cieplna złącza po spawaniu nie jest wykonywana. Precyzyjnie kontrolowane cykle cieplne, o zdefiniowanych temperaturach maksymalnych w szczególnych obszarach złącza, mogą być stosowane, podczas spawania wielowarstwowego, do przywrócenia własności mechanicznych w krytycznych rejonach SWC zamiast typowej obróbki cieplnej po spawaniu (PWHT).

* WELDING RESEARCH INSTITUTE – INDUSTRIAL INSTITUTE OF SE, BRATYSLAVA, SLOVAKIA

** INSTITUTE OF WELDING, 44-100 GLIWICE, 16-18 BL. CZESŁAWA STR., POLAND

*** NDE CENTER, JAPAN POWER ENGINEERING AND INSPECTION CORPORATION (JAEIC), YOKOHAMA, JAPAN

**** NDE CENTER, JAPAN POWER ENGINEERING AND INSPECTION CORPORATION (JAEIC), YOKOHAMA, JAPAN

1. Introduction

The repair welding in nuclear industry is sensitive task. Because of that, the relevant codes follow the 'as safe as possible' approach, which in repair welding practice means more severe conditions for preheating, post weld heat treatment (PWHT) as well as for welding procedure qualification. However, the repair costs have become important issue recently. The time factor is also very significant for periodical as well as emergency maintenance. In nuclear industry, additionally, the radioactive environment is considered to be other serious practical time limitation for maintenance activities. The driving force for current research in the repair welding is to save a layoff time, providing the safety standard are kept as high as possible.

Therefore, any effort of quantifying the effect of simplified welding procedures on the structure and properties of a weld joint is potentially very valuable. SQV2A Manganese-Molybdenum-Nickel ferritic steel has been developed for pressure vessel fabrication in Japan. Due to its chemical composition (see Table 1) and carefully controlled heat treatment the SQV2A steel consists of fine-grained tempered martensite/lower bainite microstructure, which exhibits well-balanced combination of strength and low temperature toughness.

TABLE 1

Chemical composition of steel SQV2A, and welding wire TGS-56

Material	Element content [%]								
	C	Mn	Si	P	S	Cr	Ni	Mo	Cu
SQV2A	0.18	1.43	0.28	0.006	0.002	0.15	0.69	0.51	–
TGS-56	0.09	1.58	0.41	0.007	0.007	–	0.66	0.52	0.16

However, this balance is disturbed by the thermal cycles experienced during multi-pass (repair) welding. A decrease in toughness of some regions in the heat affected zone (HAZ) is the most critical aspect. The lowest toughness values are frequently attributed to a partial austenite formation followed by partial transformation into fresh brittle martensite (called M-A constituent) when the coarse grained HAZ (CGHAZ) experiences a thermal cycle between A_{C1} and A_{C3} – inter critically heated CGHAZ (ICCGHAZ) during multi-pass welding [1, 2, 3].

A full scale PWHT at 620°C for 60-120 min. usually improves the mechanical behaviors of ICCGHAZ to requested levels (hardness HV1 <350, impact energy ≥ 200 J which is app. 70% of base metal) providing the cooling time times $\Delta t_{8/5} = 6-40$ s (low heat input welding) are adopted [4]. Additionally, PWHT removes hydrogen trapped in the microstructure during welding.

Indeed, the welding shops are equipped with furnaces and other auxiliaries to be able to perform PWHT on any large welded structure. However, the situation becomes critical, when on-site local (repair) welding takes place. Difficult access and a presence of other facilities make the in-situ PWHT almost inapplicable.

Following the wide research, the ASME CODE (Section XI, Case N-432-1, Boiler and Pressure Vessel Code) has introduced relieved approval for Repair welding using Automatic or Machine GTAW Temper Bead technique. The most important innovation is decreasing in formerly required 6 Layer technique to 3 Layer; providing that the weld heat input for each of the first three layers shall be controlled to within 10% of that used in the procedure qualification test; and weld beads are deposited in manner that assures suitable mechanical properties of the ferritic weld metal and base metal heat affected zone. The 150°C preheating and 220-290°C PWHT (hydrogen baking) are obliged.

According to investigation on the effect of Gleeble simulated welding cycles on toughness of SQV2A steel, both Tempering and Quenching modes led to desired mechanical behavior across the BM ICCGHAZ, even when no PWHT is applied [1].

1. Tempering mode relies on strict tempering effect of BM IC CGHAZ, which is tempered by several thermal cycles not exceeding the A_{C1} temperature. When proper tempering cycle is applied, not only absorbed energy is improved to about the 70% of that of parent metal but also hardness is decreased bellow threshold limits (350 HV1). During real welding, 2nd subsequent layer would provide tempering cycle. In other words as more as two welding layer would be enough to obtain the desired mechanical behavior of BM ICCGHAZ. It was proved, that the mechanical properties of ICCGHAZ can be significantly improved even when cooling time $\Delta t_{8/5} = 6$ s and tempering thermal cycle with $T_p = 300-620^\circ\text{C}$ are used [4]. Both mentioned processes led in BM HAZs to impact energy approximately 200 J and hardness not exceeding 350 HV1.
2. When Quenching mode is operating, the BM IC-CGHAZ is refined by thermal cycle in magnitude of app. $A_{C3} - 1000^\circ\text{C}$. BM ICCGHAZ microstructure is passing full austenite transformation following by fine grain martensite/lower bainite forming during cooling down. The aim is to get smaller effective grain size, which effectively controls impact energy. The following thermal cycle then temper fine-grained microstructure. In this is case the absorbed energy of BM ICCGHAZ is improved to more than 70% of that of parent metal but the hardness is still higher than 350 HV1. During real welding, the

2nd welding layer provide proper quenching cycle in BM ICCGHAZ; and the 3rd welding layer, producing the tempering effect in BM ICCGHAZ, is essential but not sufficient. It is also reported that quenching refining thermal cycle (low temperature austenitisation at app. 900°C) introduced to CGHAZ produces fine grained HAZ (FGHAZ), which results in high absorbed energy (app. 250 J) when additional tempering cycle at temperatures below A_{C1} and cooling time $\Delta t_{8/5} = 3.5$ s (low heat input welding) is applied [5].

It was found out in extensive research that several simple geometric conditions have to be fulfilled to weld

in tempering or quenching mode respectively [7]. The results are summarized in Table 2. The bead nomenclature is explained in Figure 1.

In Table 2, conservative mode means that welding operator is unable to set up and control the relative position between adjacent beads and layers (weld lamination).

In Nonconservative mode the welding operator is able to set up the relative position between adjacent beads and layers. All experiments have been done with the same parameters over the whole welding (so called CONSISTENT welding).

TABLE 2

The most important geometry conditions for Welding Mode estimation [7]

Geometry condition: Conservative Mode	Explanation
$BH_{min} + P_{min} > A_{C1max}$	Tempering from 2 nd Layer
$BH_{max} + P_{max} < A_{C3min}$	Quenching from 2 nd Layer
$BH_{max} + P_{max} < A_{C3min}$ and $2x BH_{min} + P_{min} > A_{C1max}$	Quenching from 2 nd Layer + Tempering from 3 rd Layer
Geometry condition: Nonconservative Mode	
$BH_{min} + P_{min} > A_{C1min}$	Tempering from 2 nd Layer
$BH_{max} + P_{max} < A_{C3max}$	Quenching from 2 nd Layer
$BH_{max} + P_{max} < A_{C3max}$ and $2x BH_{min} + P_{min} > A_{C1min}$	Quenching from 2 nd Layer + Tempering from 3 rd Layer

Where: BH – bead height, P – bead fusion depth.

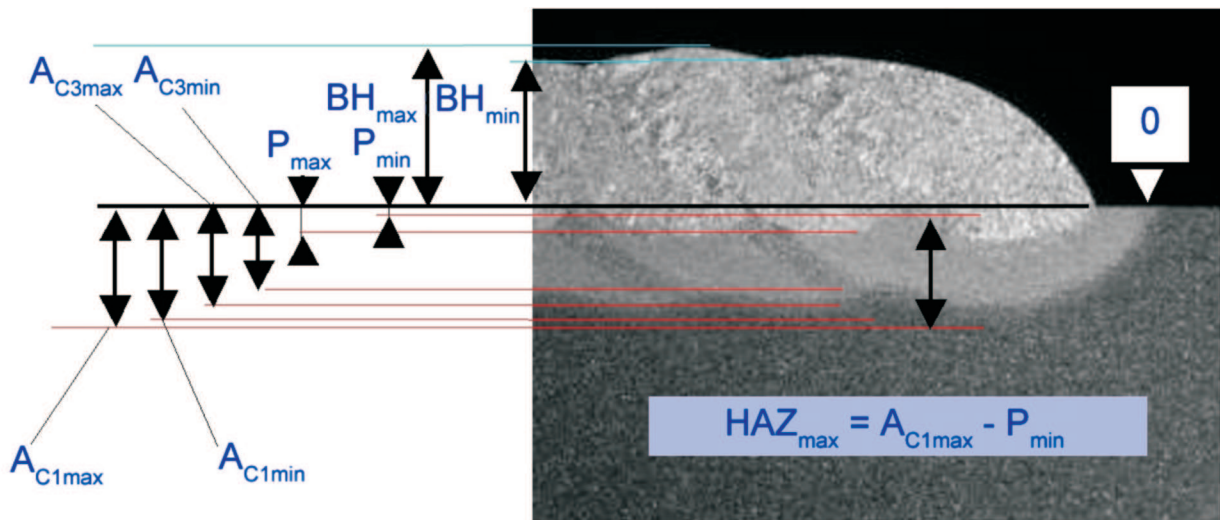

Fig. 1. The measurement nomenclature for geometry estimation [7]

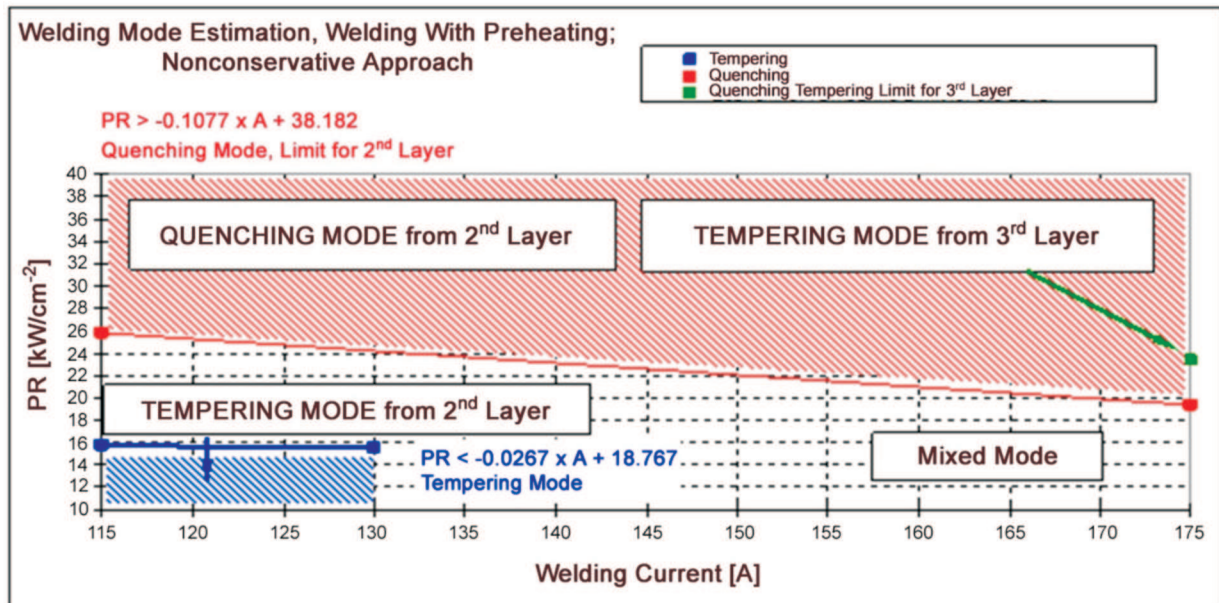

Fig. 2. Welding Mode Estimation – nonconservative approach [7]

The relations highlighted in Table 2 were measured for almost 100 combinations of welding parameters commonly used for automate GTAW welding with one exemption: It is obvious that the volume of added consumable (the feeding wire in case of automate GTAW) has some influence on weld geometry. Due to this, the Power Ratio (1) was used instead of heat input to check its competence to control the weld geometry:

$$\text{Power Ratio (PR)} = \frac{\text{Amperage [A]} \times \text{Voltage [V]}}{\frac{\text{Wire Feed Speed [cm} \times \text{min}^{-1}\text{]} \times \text{A}}{\text{Travel speed [cm} \times \text{min}^{-1}\text{]}}} = W \times \text{cm}^{-2} \quad (1)$$

A = cross-sectional area of filler wire (cm²)
 Deposited area

Data shows on Figure 2 relates to the following welding conditions:

Automatic GTAW. Bead on plate: Single Layer – 6 Beads.

Welding Position: Flat (1G). Overlap 50%.

Base metal: SM 400A plane steel (used for better distinguishing between different BM heat affected zones).

Constant welding parameters for all welding conditions: Voltage 10 V, Welding Speed 8 cm/min, Shielding Gas: Ar = 18 l/min.

Welds manufactured with preheating: Preheating: 150°C, Interpass: 150-160°C.

The areas of validity for Tempering and Quenching modes respectively are summarized in Figure 2. When preheating is employed, the CONSISTENT welding is restricted to very narrow area. Anyway, the calculations give the possibility to get desired properties employing

only 3 Layer techniques. The mutual validity of CONSISTENT QUENCHING from 2nd Layer and CONSISTENT TEMPERING from 3rd Layer was approved only for PR = 30 kW×cm⁻² and high heat input (HI) (13.13 kJ/cm) when preheating was employed.

The main aim of this article is to acknowledge the Three-layer Temper Bead technique based on strict tempering of BM HAZ instead of Six Layer Techniques when repair welding of SQV2A pressure vessel steel is applied.

2. Experimental program

The possibility for use the Three-layer Temper Bead technique during the repair welding was investigated for both Tempering and Quenching mode respectively.

For Tempering Mode estimation, HI = 8.63 kJ/cm and PR = 15 kW×cm⁻² were chosen, see Figure 2. For Quenching Mode estimation, the weld manufactured at HI = 9.3 kJ/cm and PR = 32.84 kW×cm⁻² were chosen. Both welds were manufactured on SQV2A BM employing 150°C preheating to fulfill the ASME requirements. Table 3 summarizes the welding conditions for both welding modes used.

The layout of test block for Tempering Mode welding is seen in Figure 3. For thermal cycle evaluation, 6 thermocouples were used with location at different distance from test block surface to increase the probability to localize the thermocouple directly to BM CGHAZ. Specimen from 1st, 2 and 3rd Layer welds were used for hardness measurements and microstructure investigation.

TABLE 3

The welding parameters used for multi-layer welding [7]

Parameter	Welding mode (CONSISTENT)	
	Tempering from 2 nd	Quenching from 2 nd
BM:	SQV2A, 200 x 300 x 36 mm plate	
Welding Wire:	TGS-56, ϕ 1.2 mm, low alloy by Kobelco	
Shielding Gas [l/min]:	Argon, 18	
Preheating temperature [°C]:	150	
Inter-pass temperature [°C]:	150-160	
Heat Input [kJ/cm]:	8.6	9.3
Welding Current [A]:	115	150
Welding Speed [cm/min]:	8	10
Welding Voltage [V]:	10	
Wire Feeding Speed [cm/min]:	52.4	42
Power Ratio [kW \times cm ⁻²):	15	32.8
Number of Layers:	3	6
Lamination [%]:	0	50

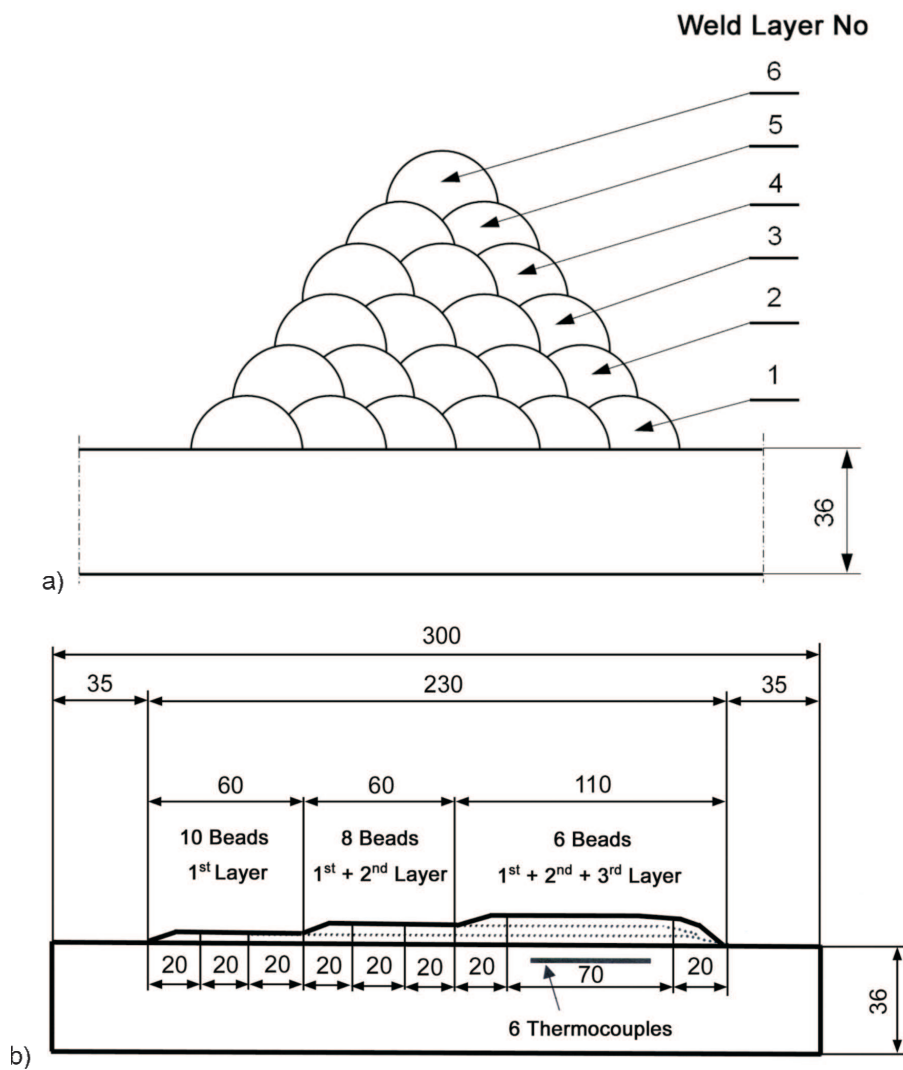

Fig. 3. Test Block for multilayer welding: a) QUENCHING Mode, b) TEMPERING Mode [7, 8]

The layout of test block for Quenching Mode evaluation is given in Figure 4. The peak temperature from each particular weld layer was estimated from the experiments with the same layout of test block and same welding conditions [8] and are summarized in as follows: 2nd Layer Peak Temperature: 960°C, 3rd Layer Peak Temperature: 705°C.

The A_{C1} and A_{C3} temperatures are: $A_{C3} = 834^{\circ}\text{C}$, $A_{C1} = 672^{\circ}\text{C}$.

As it can be understood, the Quenching Mode from 2nd Layer is operating. On the other hand, the Tempering Mode from 3rd Layer is not operating, which is in agreement with prediction in Figure 2.

Specimen from 1st, 3rd and 6th Layer welds was used

for hardness measurements and microstructure investigation.

3. Results and discussion

3.1. Quenching Mode

The macro-view of weld manufactured employing the Quenching Mode is seen in Figure 4. The weld deposit is free from cracks, pores and lack of fusion. The microstructure of BM CGHAZ was evaluated in single and three-layer welds (the welds with only two Layers were not available).

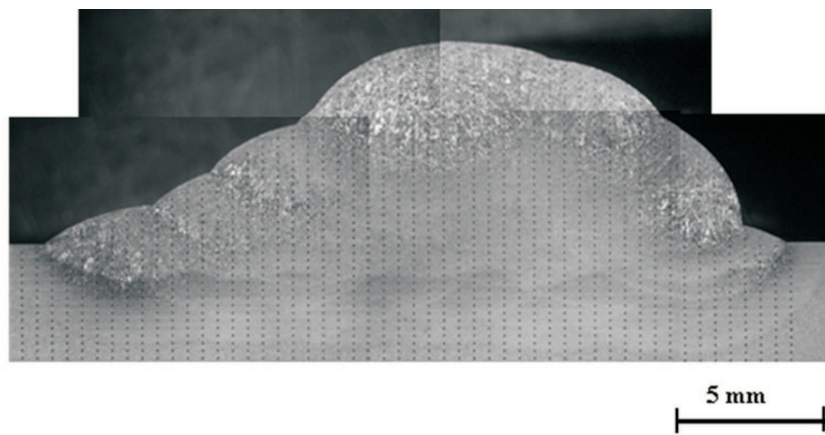

Fig. 4. Welded Block, Quenching Mode, 6 Layer weld. Etch. Adler [7]

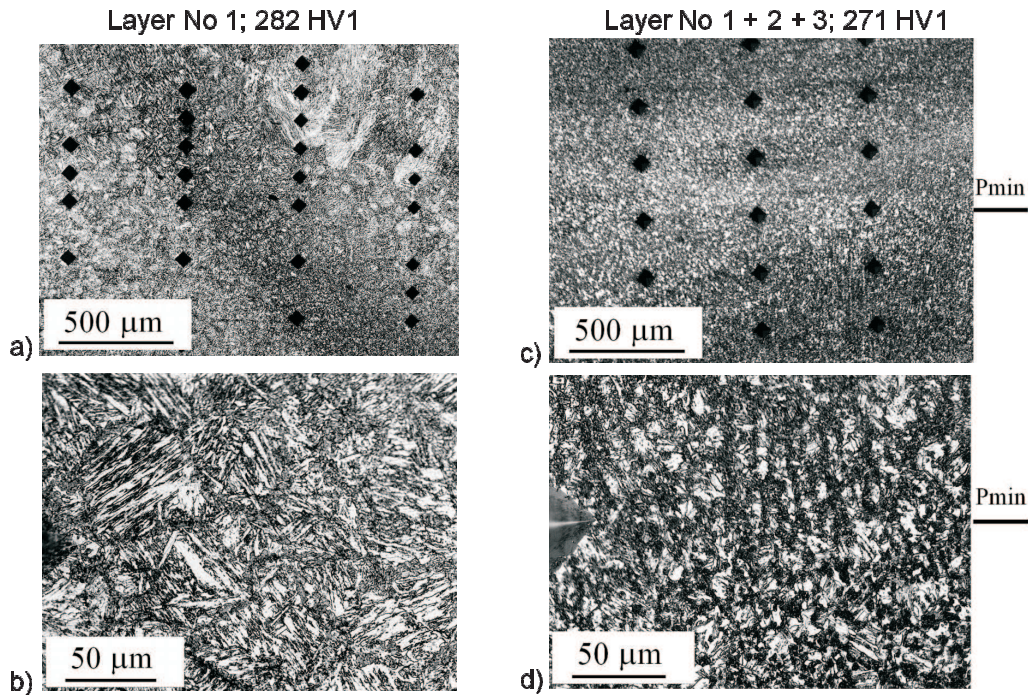

Fig. 5. Microstructure of BM ICCGHAZ documented in Single Layer welds and after manufacturing of first 3 layers. Quenching Mode. P_{\min} – minimal bead fusion depth. Etch. Nital [7]

Figure 5 documents the microstructure of BM IC-CGHAZ between 3rd and 4th bead in single layer weld (Figures 5a and 5b); the same area was documented in 3rd layer weld (Figures 5c and 5d). The BM ICCGHAZ is clearly visible in center of Figure 5a; and in Figure 5b (higher magnification).

The microstructure of BM ICCGHAZ consists of typical martensite + upper bainite microstructure. The coarse former austenite grain is fully decorated by fresh M-A component, which transformed from fresh austenite on cooling from IC temperatures experienced by BM CGHAZ during manufacturing of subsequent bead. The hardness 282 HV1 indicates the sharp tempering effect from other successive weld beads.

The principally same position in microstructure (between 2nd and 3rd beads of 1st layer) is documented in three-layer welds. Although the grain refinement is vis-

ible in Figure 5c, the more precise investigation shows double IC influence (Figure 5d).

In lower right corner, the IC microstructure produced most probably during manufacturing of second layer can be seen. The upper parts of Figure 5d are clearly influenced by IC thermal cycle. Since the estimated peak temperature from 3rd layer is 705°C in BM CGHAZ ($A_{C1} = 672^{\circ}\text{C}$). Improper 3rd Layer could produce the observed IC microstructure. The hardness 271 HV1 indicates the tempering effect from subsequent beads followed afterward.

Hardness measurements

Because of not clear tempering effect, which might come from subsequent beads of the same, and following layer, it was decided to measure hardness HV1 in whole weld deposit. The Layout of indentation is clear from upper parts of Figure 6 (single layer).

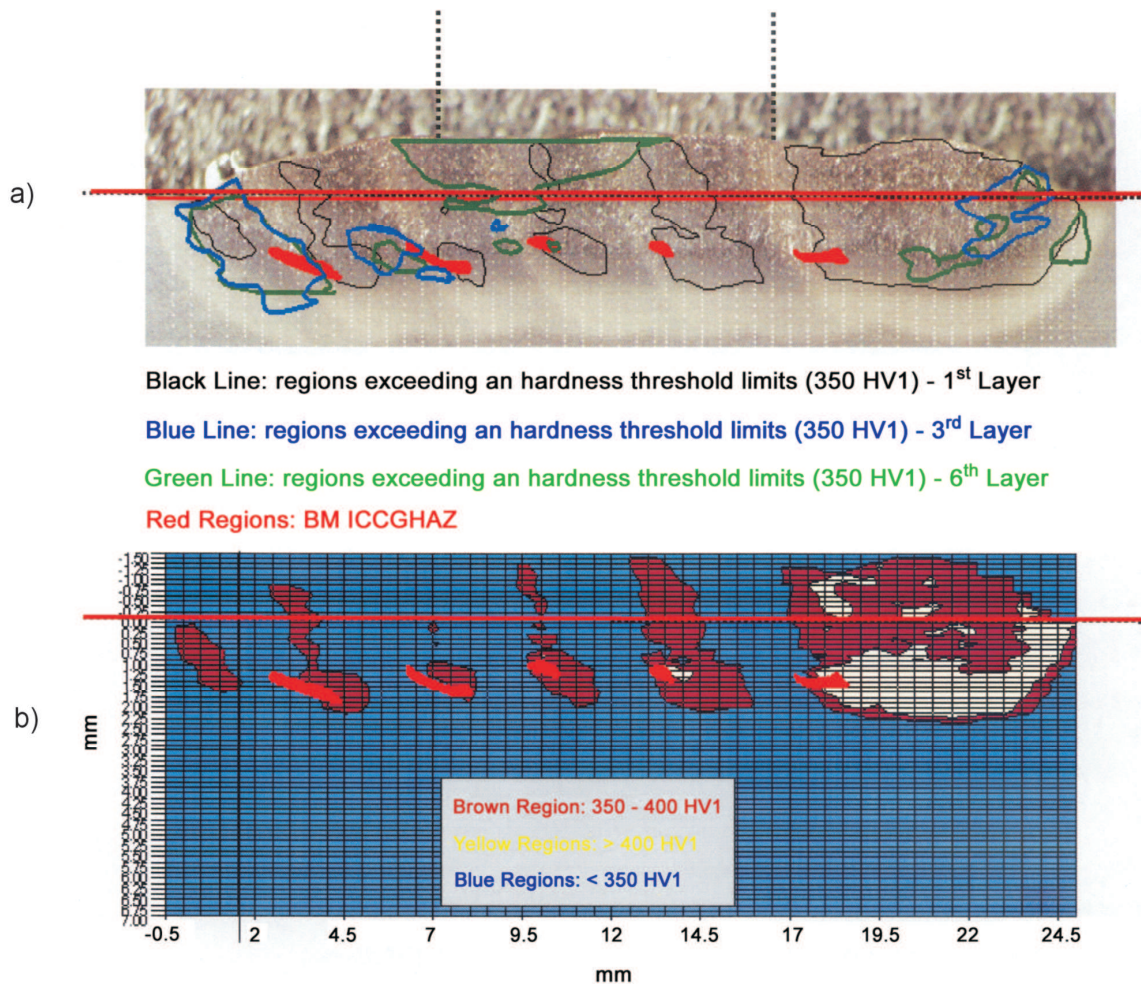

Fig. 6. Quenching Mode: The regions exceeding a 350 HV1 threshold limits. Hardness measured after manufacturing of 1st, 3rd and 6th Layer [7]: a) macro photograph of single layer, regions exceeding hardness HV1 threshold in 3 layer welds and in 6 layer weld respectively; b) regions exceeding 350 HV1 hardness limits in single layer

The horizontal distance between indentations was 0.5 mm; vertical distance was 0.25 mm and 0.5 mm depending on distance from fusion line. The same method was used for three and six layer welds. The most important findings are surveyed in Figure 6. Figure 6b shows areas of single layer welds, in which the hardness exceeded a 350 HV1 threshold. The six weld beads are clearly visible, bead on right side of Figure 6b was manufactured at last; its hardness could serve for comparison. The single layer weld can be divided onto two principal areas: those hardened by subsequent bead followed by tempering from other beads of the same layer; and those only tempered by subsequent and every other beads of the same layer.

The red areas in Figure 6 are BM ICCGHAZs identified by light microscopy. It can be seen that these areas roughly coincide with the hardness, which exceeds exceeding the threshold limits. On the other hand, the hardness in BM ICCGHAZ documented in Figure 5 is lower. The threshold limit areas don't correspond with BM ICCGHAZ between 2nd and 3rd beads. The areas in which the threshold limits is exceeded, are decreasing progressively with the increased distance from the last bead. The tempering is effective on relatively long distances. The distance between 6th bead and 3rd bead is 12 mm.

The areas exceeding the 350 HV1 limits in 3 layer and 6 layer welds are seen in Figure 6. Only areas between dotted vertical lines are taken into account, since the weld block for Quenching Mode evaluation has a pyramid layout. It can be seen, than some areas exceed hardness limits even in 6 layer welds. It is clear that combination of common HI and lower PR brought no advantage. The energy released from arc is wasted for multiple unwanted microstructure reheating. Although the tempering effect from subsequent beads of 1st layer is favorable, it is cancelled by quenching thermal cycles, which originate in subsequent layers.

3.2. Tempering Mode

The macro-view of weld manufactured employing the Tempering Mode is seen in Figure 7. The weld deposit is free from cracks, pores and lack of fusion.

The data from thermocouple with the highest peak temperature recorded during multi-layer welding are used for thermal cycle evaluation, Figure 8. The highest peak temperature was recorded during manufacturing of 4th Bead in 1st layer; the temperature corresponds to BM CGHAZ. The peak temperature from 2nd Layer lie below A_{C1} , which confirms the calculations for Tempering Mode operability when welding with preheating is used (see Figure 2). The peak temperature from 2nd layer is higher than those proposed by Mizuno [1] for optimal Tempering Cycle (500°C). However, the latest Gleeble results confirmed the impact energy as high as 190 J in BM ICCGHAZ tempered at 650°C by first tempering cycle followed by second tempering cycle with peak temperature 450°C. It can be also understand from Figure 8, that multi-layer multipass welding provide several other effective tempering cycle, which come both from subsequent beads of the same layer or from subsequent layer.

The microstructure of BM ICCGHAZ between 5th and 6th beads in single layer weld and after manufacturing of second layer is seen in Figures 9a-d. The BM ICCGHAZ is clearly visible in center of Figure 9a (single layer) as well as in center of Figure 9c (two layers). The A_{C1} - A_{C3} layout is visible in both investigated microstructures, which means that mentioned areas were not re-austenitised during manufacturing of 2nd layer. The more precise observations at higher magnification reveal microstructure typical for BM CGHAZ microstructure which passed IC cycle in single layer weld (Figure 9b): coarse former austenite grain, the prevailing tempered martensite and necklace (the most probably M-A) around whole former austenite grain.

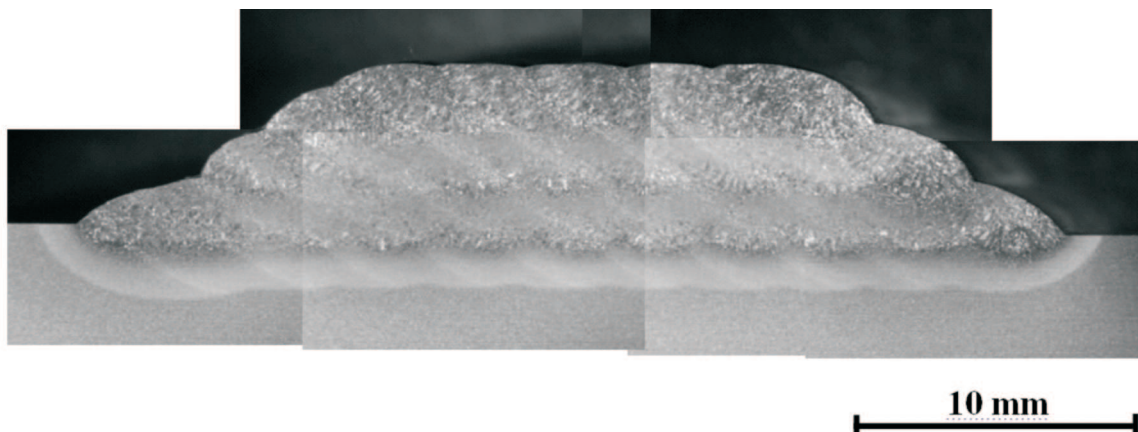

Fig. 7. Welded Block, Tempering Mode, 3 Layer weld. Etch. Adler [7]

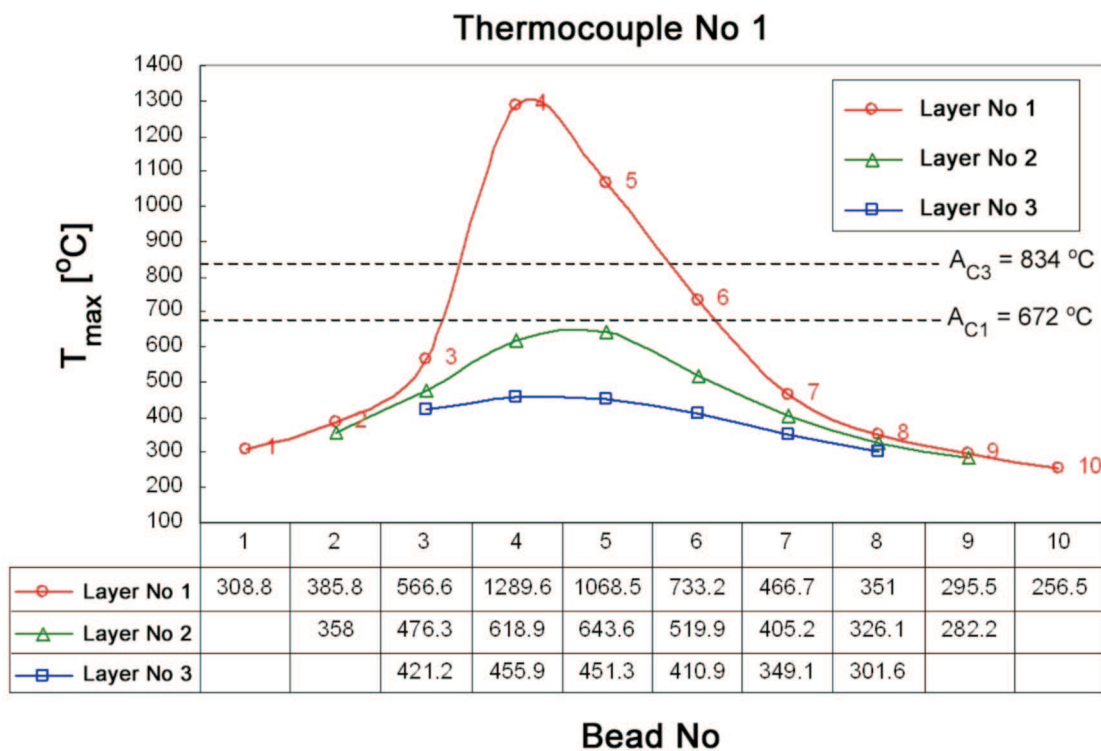

Fig. 8. Measured Thermal cycles. Tempering Mode. The peak temperatures: 1st Layer = 1289°C, 2nd Layer = 643°C, 3rd Layer = 455°C [7]

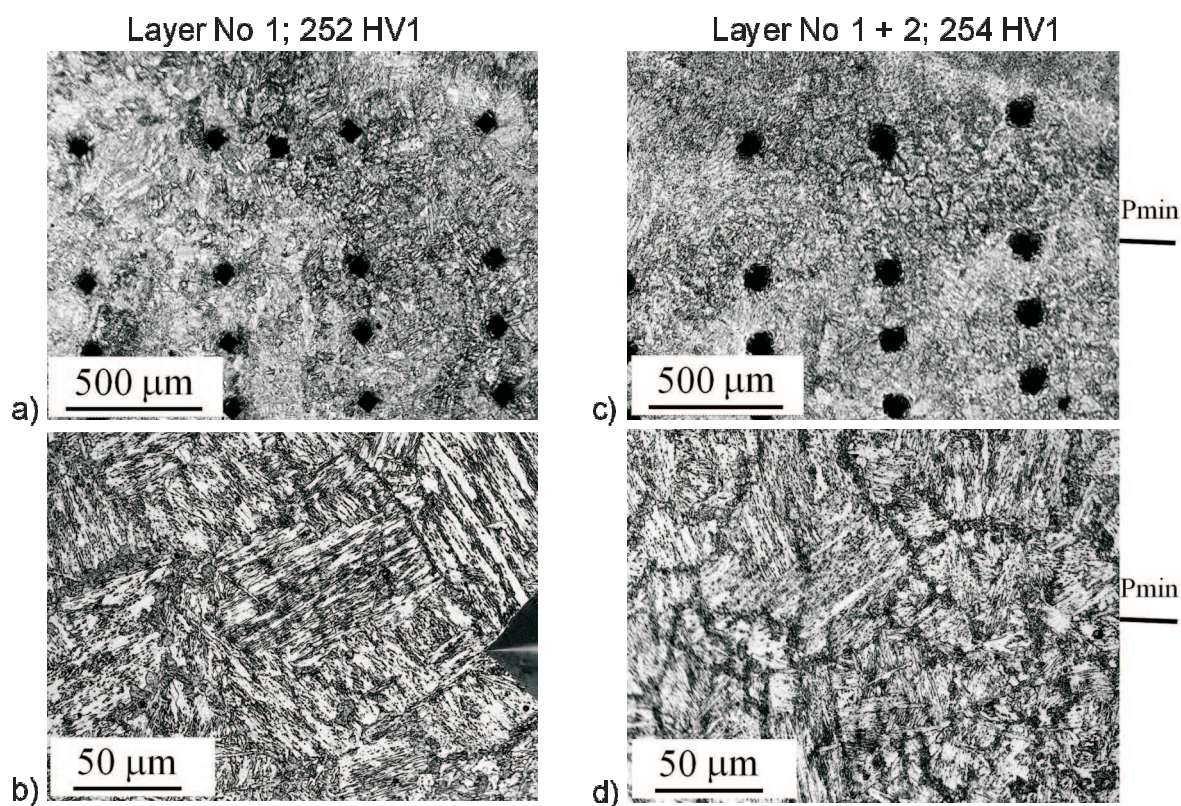

Fig. 9. Microstructure of BM ICCGHAZ documented in Single Layer welds and after manufacturing of first 2 layers. Tempering Mode. Etch. Nital [7]

Some M-A was found also inside the grain. The gray necklace coloration is typical for already decomposed M-A. The tempering is also confirmed by low hardness (252 HV1). The 2nd layer caused additional tempering, Figure 9d. The necklace is darker; also areas in grain seem more gray, which can be manifestation of carbide precipitation. The hardness HV1 remains same as that measured in single layer weld, perhaps due to mutual effect of precipitation hardening and matrix softening.

Hardness measurements

The influence of welding in Tempering Mode on hardness HV1 evolution in central region of weld block is seen in Figure 10. Together 13 hardness columns were measured. The horizontal distance between indentations was 0.5 mm, vertical distance was 0.5 mm (weld and BM) and 0.25 mm (HAZ) respectively. The hardness

was measured in the same beads after manufacturing of 1st, 2nd and 3rd layer.

It is clear that Tempering Mode of welding produces the same hardness regions as that observed in welds manufactured by Quenching Mode. On the other hand, as early as 2nd Layer provides complete hardness relieving, 3rd Layer doesn't cause any dramatic changes. The hardness layout is regular. The Figure 11 show the hardness evolution in areas hardened during manufacturing of 1st Layer and in areas effectively tempered by subsequent beads of 1st Layer. It can be seen, that tempering cycles from 2nd Layer remove the hardness peaks. On the other hand, the areas already tempered by subsequent beads of 1st Layer remain almost unaffected by tempering cycles from 2nd Layer. The hardness measured in 3 Layer specimen caused only minimum changes.

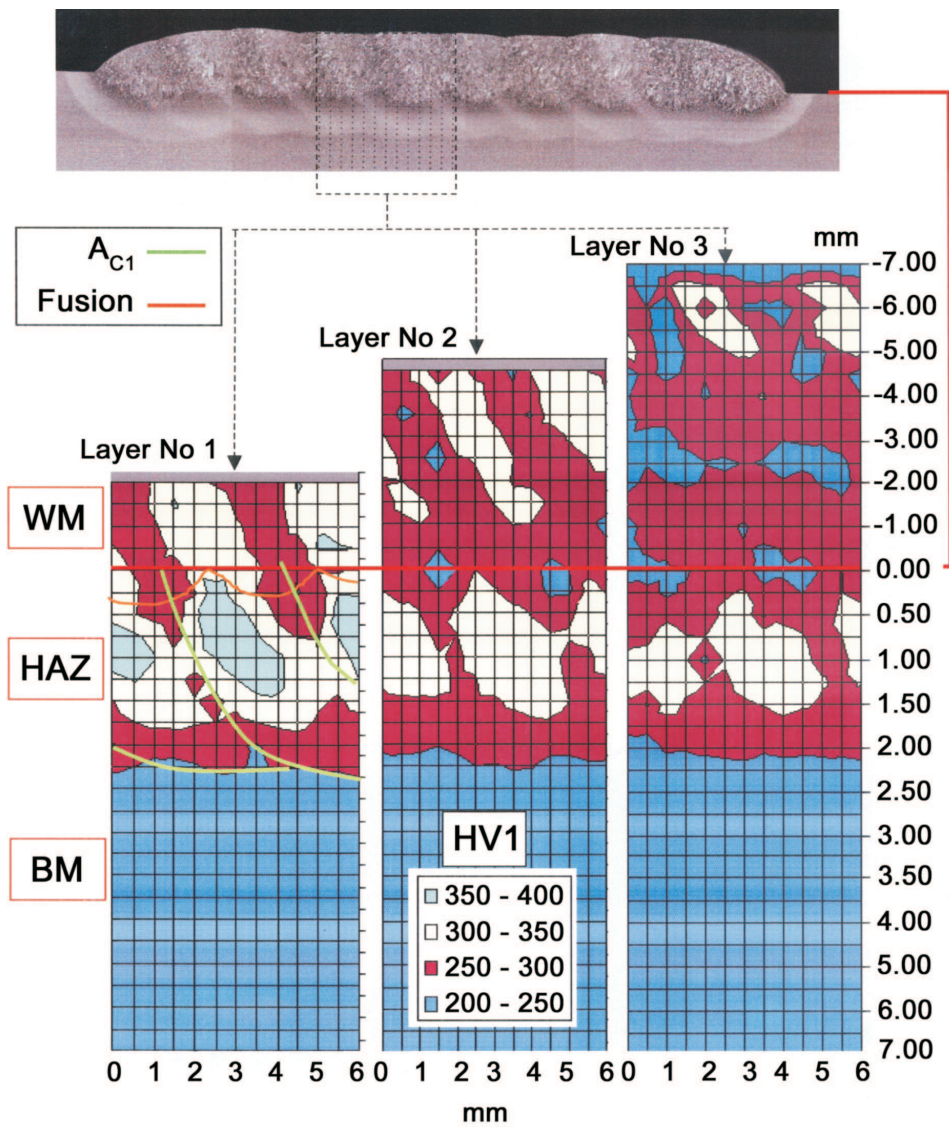

Fig. 10. Tempering Mode: Hardness HV1 measurement after manufacturing 1st, 2nd and 3rd Layer (WM – weld metal, BM – base metal) [7]

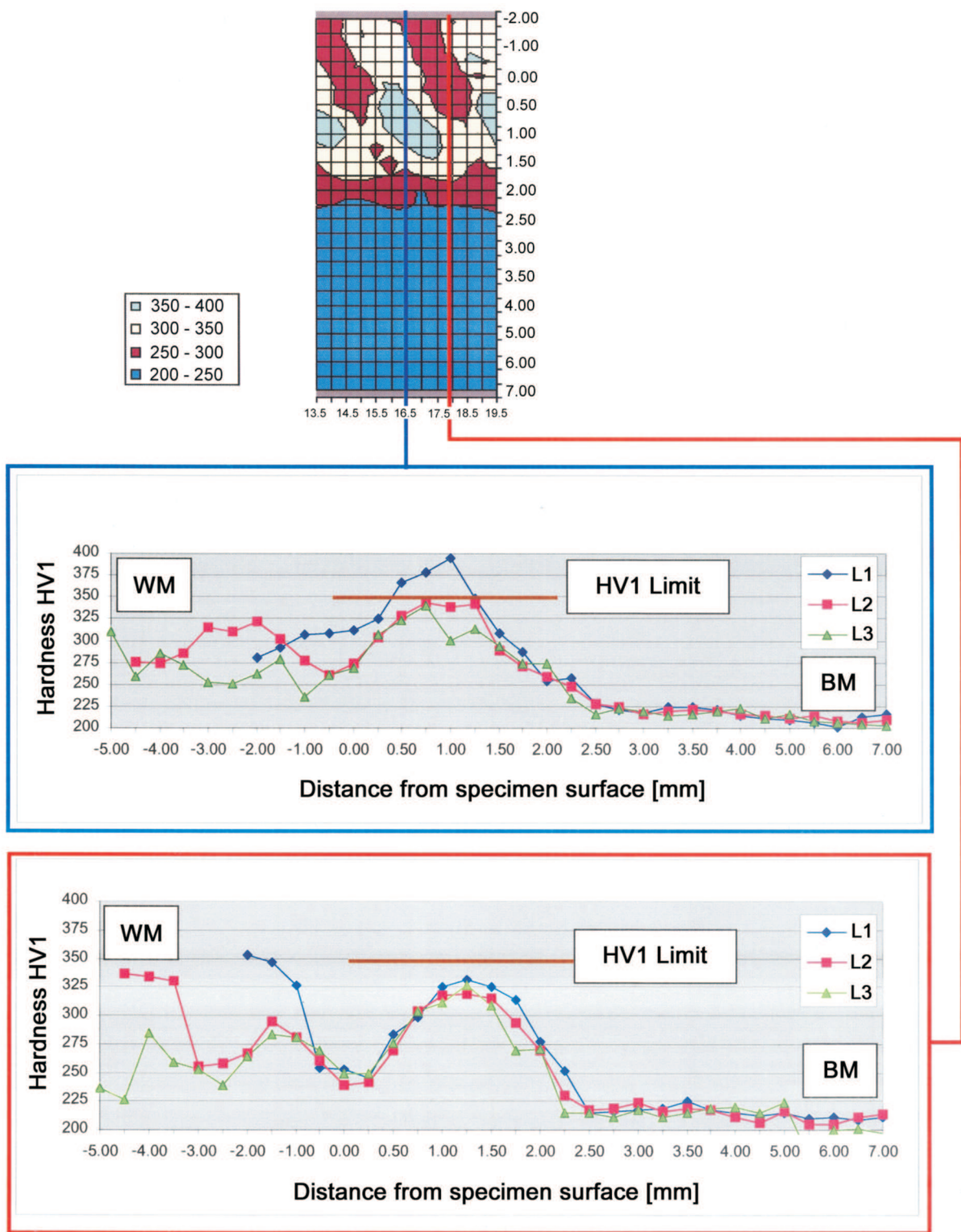

Fig. 11. Tempering Mode: Hardness HV1 measurement after manufacturing of 1st, 2nd and 3rd Layer. Hardness evolution in regions, which were hardened or tempered during manufacturing of 1st Layer [7]

The higher tempering affectivity in hardened areas can be explained as follows:

The areas exceeding the HV1 limit in 1st layer welds consist from meta-stabile structures like martensite or

upper bainite. The carbon is over-saturated in these structures; and the driving force for tempering will be higher, that in structures already tempered.

4. Conclusions

1. From technological operability and bead appearance viewpoint, Both Tempering and Quenching Mode can be used for Multi-Layer Welding with preheating 150°C.

2. The Tempering Mode employing consistent technique gives smoother HV profiles; subsequent Layer only tempers BM ICCGHAZ. The limit 350 HV1 is fulfilled even after manufacturing of 2nd layer.

3. Quenching Mode employing consistent technique (without completed tempering effect from 3 Layer) shows more complicated HV distribution; ICCGHAZ experienced multiple thermal cycles exceeding A_{C1} or A_{C3} temperatures. HV1 exceeds the limits several times when three-layers are manufactured.

4. Consistent 3 Layer welding can be recommended for Tempering mode. The T_{max} from 2nd Layer was approximately 650°C, but latest Gleeble results (after Mizuno) confirmed the impact energy as high as 190 J in BM ICCGHAZ tempered at 650°C by first tempering cycle followed by second tempering cycle with peak temperature 450°C.

5. It was confirmed that 1st and 2nd Layer for Quenching Mode could be manufactured by consistent welding. The parameters of 3rd Layer would be set up to move the A_{C1} isotherm away from BM ICCGHAZ (same HI, increased PR) to get the proper tempering effect.

6. The application of 150°C preheating reduces the applicability area for Tempering Mode. Any relieve in preheating temperature of would be beneficial.

7. The mutual quenching effect from 2nd layer and tempering effect from 3rd layer is almost inapplicable for CONSISTENT welding with preheating; and restricted to very narrow area for welding without preheating.

8. If CONSISTENT quenching method is applied for 1st and 2nd layer; and weld parameters are aligned for 3rd to get proper tempering mode layer, three-layer temper bead welding would ensure the required mechanical properties for quenching mode

Acknowledgements

The authors are grateful to Kenji IKEUCHI, Professor at JWRI, Osaka University; and to Makoto TAKAHASHI, associate professor at JWRI, Osaka University, for their collaboration and support on this research.

The authors (P. Brziak and M. Łomozik) wishes to acknowledge the Japan Society for the Promotion of Science (JSPS) for supporting him within "Postdoctoral fellowship for Foreign Researchers".

REFERENCES

- [1] R. Mizuno et al., Investigations on welding procedure of temper bead welding for SQV2A pressure vessel steel, Final Report, September (2002).
- [2] ASME Boiler and Pressure Vessel Code, CASE-N432-1, March (2001).
- [3] D. W. Gandy, S. J. Findlan, Temperbead Welding Repair of Low Alloy Pressure Vessel Steels, EPRI Research Project C104-02, Final Report, December (1993).
- [4] L. Liao, Influence of M-A Constituent on Weld HAZ Toughness of Low Alloy Steel SQV2A for Pressure Vessels, PhD Thesis, JWRI, Osaka University, (1995).
- [5] P. J. Alberry, Sensitivity Analysis of Half-Bead and Alternative GTAW Techniques, Welding Research Supplement, 442-51, November (1989).
- [6] P. J. Alberry, R. R. L. Brunstrom, K. E. Jones, Computer model for predicting heat-affected zone structures in mechanized tungsten inert gas weld deposits, Metals Tech. 10 (1), pp. 28-38, (1983).
- [7] P. Brziak, Temper Bead Repair Welding of Low Alloy SQV2A Pressure Vessel Steel. Controlling the weld geometry to achieve the best mechanical and metallurgical performance of critical weld regions. JAPEIC, Tarasaki R&D, Hitachinaka, Japan, Final Report, December (2002).
- [8] M. Łomozik, Investigations on welding thermal cycles in temper bead welding process for ductility improvement. JAPEIC, Tarasaki R&D, Hitachinaka, Japan, Final Report, July (2001).