

Microstructure and fatigue life of Cp-Ti/316L bimetallic joints obtained by means of explosive welding

M. WACHOWSKI^{1*}, L. ŚNIEŻEK¹, I. SZACHOGLUCHOWICZ¹, R. KOSTUREK¹,
AND T. PŁOCIŃSKI²

¹Military University of Technology, Faculty of Mechanical Engineering, Warsaw, Poland, 2 Gen. Urbanowicza Street, 00-908 Warsaw, Poland

²Warsaw University of Technology, Faculty of Materials Science and Engineering, 141 Wołoska Street, Warsaw, Poland

Abstract. This paper describes a study of explosively welded, commercially pure titanium-stainless steel 316L plates. Following welding, the plates were heat-treated at the temperature of 600°C for 90 minutes. Examinations of the bond structure were carried out before and after heat treatment to investigate the processes taking place during explosive welding of materials. Observations were performed using light, scanning electron (SEM) and transmission electron microscopy (TEM). The mechanical properties were examined applying three-point bending tests with cyclic loads. Fractographic examination and hardness measurements were also performed. It has been found that the bonding zones are characterized by a specific microstructure, chemical composition and microhardness. The heat treatment used in the study increases the relative volume of brittle intermetallic phases, causing a reduction in fatigue strength of the joint.

Key words: explosive welding, joining, microstructure, fatigue life, cladding.

1. Introduction

New multilayer materials are constantly being developed to address the need for materials of superior mechanical properties and utility to be used in machinery and equipment operating under the conditions of extreme loads, high temperature and corrosive environment [1–3]. Ensuring appropriate protection for the surface layer of machinery components is one of the main requirements that are to be satisfied by state-of-the-art materials in technology and the industry [4]. If the environment in which the machinery operates is non-aggressive and the exploitation period is relatively short, simple methods of anti-corrosion protection are used. They include layers, protective coating or inhibitors [5–8]. However, when the component operates under complex strains, in a strongly corrosive environment or at a high temperature, advanced materials and protection means are necessary. A frequently used approach is cladding, i.e. covering the base plate with another material which displays completely different properties [9, 10]. Cladding is currently widely used for manufacturing industrial installations [11, 12]. One of the numerous methods for cladding different types of sheets is the explosive one. Thanks to unique properties of this method, special multilayer materials may be produced [13–16].

This study focused on explosive welding of metals. Despite the considerable interest of numerous research centers, the subject has not been fully elucidated yet. Hence the need for further studies of the method itself, description of the microstructure and the crucial aspect that is fatigue life of the sheets obtained

by means of explosive welding. The attractiveness of the subject is primarily due to the exceptional properties of explosively welded materials, different from those of sheets produced by other methods. The unique properties of explosively welded multilayer materials are determined by the processes taking place in the bond area and by the welded materials themselves [17–19]. The joint formation is closely associated with the detonation of the explosive [20]. Kinetics of the process differs from those of other conventional methods used for welding materials [13, 21].

The explosive method is used e.g. for the production of walls in sieve heat exchangers. They represent important components of cooling systems in nuclear reactors as well as chemical and petrochemical installations. These components operate in an aggressive environment and at a high temperature, under the conditions of variable strain. Economic considerations lead to limiting the use of conventional materials in this type of equipment. On the other hand, explosively welded multilayer materials fulfil the requirements completely [22–26]. Demanding operating conditions of heat exchangers require materials such as sheets clad in chromium-nickel steel and titanium [27, 28]. However, the use of titanium-steel sheets is not limited to sieve heat exchangers walls in the conventional power industry. The demand for such sheets has increased considerably due to the development of nuclear power engineering, chemistry and petrochemistry. Therefore, they have been long used for the manufacturing of columns, pipelines and pressure vessels employed in various chemical processes [29]. The analysis of data indicates that multiple materials meet the criteria of resistance to corrosion, and mechanical properties required for the construction of equipment [30–32]. However, the use of titanium-steel plated sheets considerably reduces the costs of production, increases the life cycle and reduces equipment weight.

*e-mail: marcin.wachowski@wat.edu.pl

Manuscript submitted 2018-02-19, revised 2018-03-26 and 2018-04-09,
initially accepted for publication 2018-04-16, published in December 2018.

Microscopic investigations aiming to determine the correlation between the formation of the microstructure of bonds as part of explosive welding and their mechanical properties have been conducted in many studies to date [33–36]. Due to the limitations of the research methods, it has not been possible to fully elucidate the phenomena taking place in the bond area. As a rule, two theories are suggested to explain the process of bonding metals by means of explosive welding. The first one points to adhesion as the mechanism responsible for formation of the bond and assumes that the presence of a wavy development in the joint is necessary to obtain appropriate endurance [2, 37, 38]. The other theory is based on the hypothesis that the durable bond is a result of diffusion occurring in pitted bonded materials and the accompanying formation of intermetallic phases within the joint [39]. Studies conducted to date have not found diffusion of chemical element atoms to a certain distance detectable by conventional research methods [2, 13, 14]. The current progress in development of advanced research methods, especially scanning and transmission electron microscopy, enables precise examination of the joint microstructure. Therefore, it provides the possibility to prove the presence of diffusion in the joint and determine the scale of the phenomenon. It is possible then to undertake to precisely elucidate the processes occurring within the joint and, consequently, describe the mechanism of bond formation by means of explosive welding.

The subject of the study was selected, apart from the necessity to prove the presence of diffusion in the joint, to address the technological aspect of the process of explosive welding. It concerns standard norms for manufacturing clad sheets, in particular the necessity to subject them to heat treatment. Comprehensive analysis of the effect of heat treatment conditions specified by basic standards for mechanical properties of clad sheets has not been conducted to date. Hence, such analysis is the aim of this paper. The wide application of titanium-steel plates and the requirement to apply heat treatment influence mechanical properties and, importantly, fatigue life of the components produced.

2. Experimental procedures

The study used samples taken from clad sheets prepared by Z.T.W. EXPLOMET S.C., based in Opole, Poland. The base material was the 316L austenitic steel (as per ASTM norm), whose chemical composition is presented in Table 1 [29, 40].

Table 1
Chemical composition of 316L steel

Steel type	Individual element content [mass %]					
ASME SA-516 Grade 70	C	Cr	Ni	Mn	Mo	Fe
	≤0.03	16–18	10–14	≤2	2–3	Rest

Grade 1 titanium (ASME SB-265 Gr.1) was used as the clad material due to its high resistance to corrosion and good

ductility, which means that it may be shaped while cold. The chemical composition of titanium is presented in Table 2.

Table 2
Chemical composition of Grade 1 titanium

Steel type	Individual element content [mass %]					
ASTM SB-265 Grade 1	Fe	O	N	C	H	Ti
	≤0.20	≤0.18	≤0.03	≤0.10	≤0.01	Rest

The study examined samples before and after heat treatment. The bonding of sheets was performed using the ANFO explosive. The thickness of the titanium sheet was 6 mm. The clad sheets were subjected to heat treatment, also by EXPLOMET in Opole. The sheets were heated to 600°C, at a heating rate of 95°C/h, with the heat treatment taking place for 90 minutes at maximum temperature. The sheets were then cooled at a furnace to 300°C, at the rate of 70°C/h, and then in the air to ambient temperature.

Microstructure examinations were carried out before and after heat treatment to investigate the processes taking place during explosive welding of materials. Microstructure observations of the samples were performed using light and scanning electron microscopy (Hitachi SU 70) as well as transmission microscopy (JEOL JEM-1200EX).

The use of an original method for preparation of the specimen enabled detailed examination of the materials microstructure. The findings then provided the basis for analysis of the mechanism of bond formation by means of explosive welding. At the same time, fatigue tests were conducted to determine the effect of the bond microstructure on fatigue life of the clad sheet. Three-point bending tests with cyclic loads focused on the relation between microstructure and the mechanical properties of clad sheets both before and after heat treatment. The examination additionally involved fractography of fractures and hardness measurements.

The three-point bending tests with cyclic loads were carried out according to the ASTM A263–94a standard. A total of 21 specimens for fatigue tests were obtained from each of the sample sheets (before and after heat treatment). The samples were cut out perpendicular to the joint surface, using a wire electrical discharge machine (AU-300iA). The dimensions of the samples are presented in Fig. 1. The edges of the samples were additionally rounded to avoid the effect of stress concentration in these areas.

The loading applied during the three-point bending tests was as follows: 4, 5, 6, 7, 8, 9 and 10 kN. The cycle asymmetry coefficient was $R = 0$. The test was performed three times for each load value and discontinued when the sample broke or 2×10^6 cycles were obtained (test threshold). Titanium was stretched during the tests while steel was compressed (Fig. 2). The results of the fatigue tests were used to prepare a Wöhler graph for laminate before and after heat treatment. The examinations employed the MTS 858 material testing system at a cycle frequency of 20 Hz. The distance between the props was 5 cm.

Fractographic examination was conducted to determine the damage mechanisms in the fatigue test of layered metallic ma-

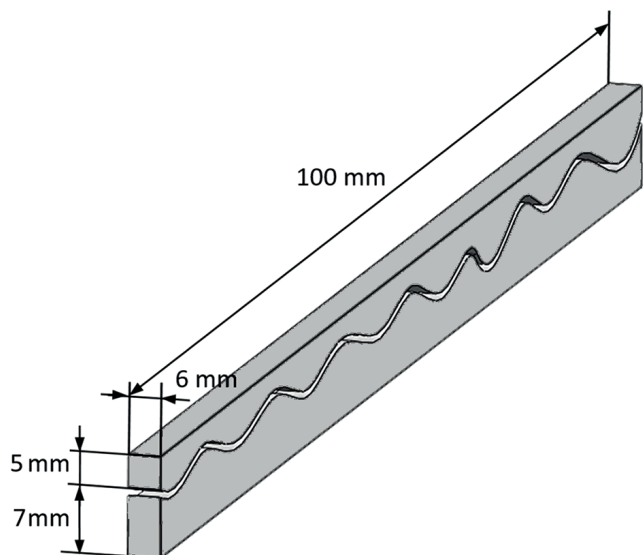

Fig. 1. Dimensions of samples for fatigue tests

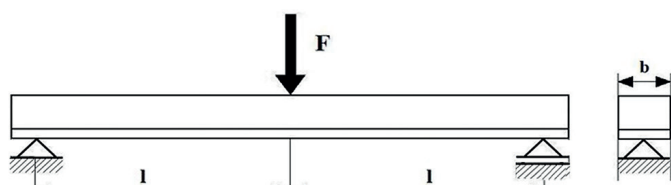

Fig. 2. Loading scheme of the sample at three-point bending tests (F – force acting on the sample, l – distance between the prop and the force application site, b – sample width)

materials obtained by means of explosive welding. The observation of fatigue ruptures was performed with a Hitachi SU 70 scanning electron microscope.

The Vickers hardness tests in the bond area were performed according to the PN-ISO 6507–3:1996 standard. Measurements were carried out with a load of 1N (HV0.1), using a light mi-

croscope with a hardness tester (Leica Miniload 2). The first two measurements were taken at a distance of 0.02 mm from the joint and the others at 0.24 mm, both in the direction of the steel and titanium. The total width of the measurement area in each of the materials was 800 μm . Therefore, the measurement covered the flyer, the parent plate and the bond area.

3. Results and discussion

3.1. Joint microstructure. Microscopic examination of clad materials showed altered morphology of the phase components and their microstructure, in particular in steel in the bond area (Fig. 3). Due to the large dimensions of the sheets, it was not possible to assess the whole bond area. For this reason, microscopic examination focused on representative areas in the middle part of the sheets. This approach enabled avoiding examination of delaminated or weakened joints found on edges and corners of the bonded sheets. Microscopic examination did not reveal any disbonding. The microstructure of joints formed by means of explosive welding shows a heterogeneous nature in the perpendicular and parallel direction to the bond area. The microstructure was altered significantly in the bond area and the microstructure of steel in the bond area did not show cracks or pores. This demonstrates that welding parameters had been selected correctly.

The microstructure of 316L austenitic steel within the bond area of the clad material was analyzed before and after heat treatment to determine changes caused by plastic deformation generated at the moment of collision of sheets, and the effect of heat treatment on the material microstructure. The microstructure of the joint formed by means of explosive welding (Fig. 3A) is heterogeneous in the direction perpendicular and parallel to the bond direction. The microstructure was altered significantly in the bond area as well as deeper into the steel and titanium. The grains of austenite close to the bond area in the material prior to heat treatment became distorted in the direction parallel to the bond propagation direction, which is

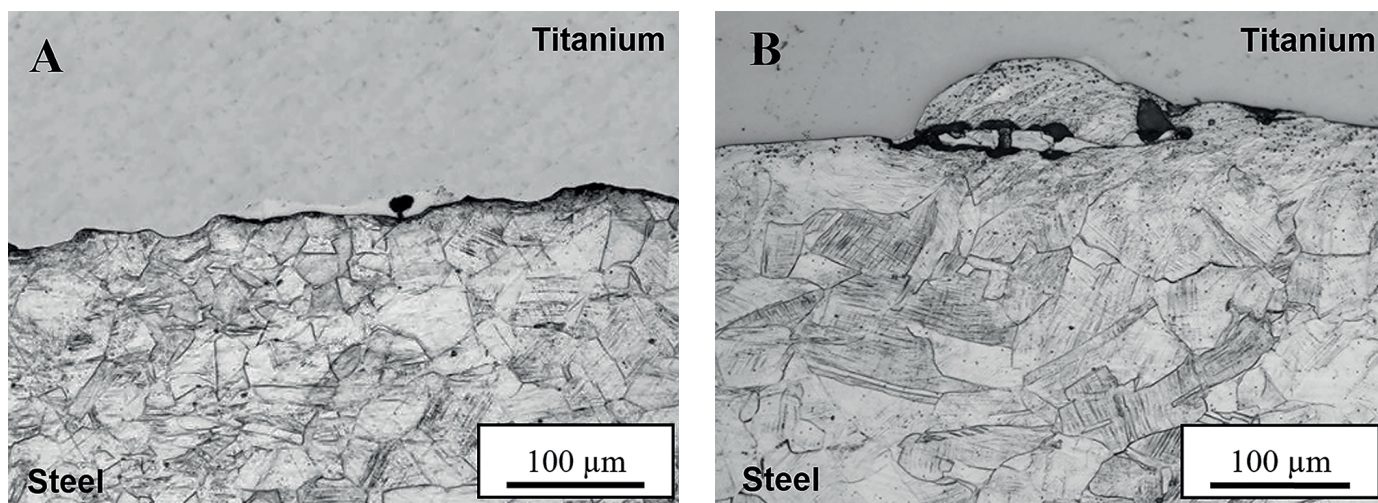

Fig. 3. Microstructure of 316L steel within the joint: A) sample before heat treatment; B) sample after heat treatment

equivalent to the direction of the explosive wave propagation and has been created by the shock wave. The altered microstructure morphology within the bond area is caused by plastic deformation of steel and titanium generated by dispersion of the kinetic energy from explosive detonation. It was found that the deformation zone was 50 μm wide and the degree of grain deformation increased with decreasing distance from the bond surface. At a larger distance, the microstructure is characterized by the presence of shear bands and deformation twins. Microscopic examination of the bond following heat treatment (Fig. 3B) revealed recrystallization effects in the grains with strong plastic deformation during the explosion. The nature of the joint in the heat-treated bond did not change and it retained its characteristics. The bond area did not show any cracks, delamination or pores. On the other hand, the results revealed unification of the microstructure of grains, their growth and vanishing of shear bands and deformation twins within the whole bond area. This indicates a recrystallizing effect of heat treatment on the bond. The dislocation density following recrystallization was considerably reduced and, simultaneously, the hardening degree decreased. These led to improvement in the plastic properties of the bonded materials. The process of recovery and recrystallization resulted in elimination of plastic deformation.

Examinations using scanning electron microscopy reveal the presence of melted zones in the bond area. This in turn reveals thermal activation of the bonding process, with the melted zones closely connected to the effect of heat. Analysis of the microstructure of melted areas in the joint between chromium-nickel steel and titanium prior to heat treatment (Fig. 4) revealed voids and numerous transverse cracks. The melted zone is located directly on the surface of the titanium-steel bond. The zone was found to contain not only titanium, but also iron, nickel and chromium (Fig. 5 and Table 3).

It was shown that, similarly as before heat treatment, the melted zone in the material after heat treatment differed with regard to the chemical composition and content of elements from

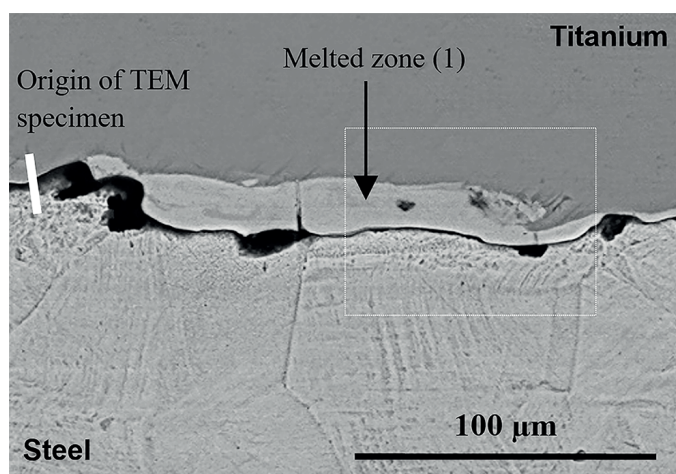

Fig. 4. Microstructure of the melted area between 316L austenitic steel and titanium prior to heat treatment, (1) – site of microanalysis of bond chemical composition (Table 3). White frame – analysis area for surface distribution of elements

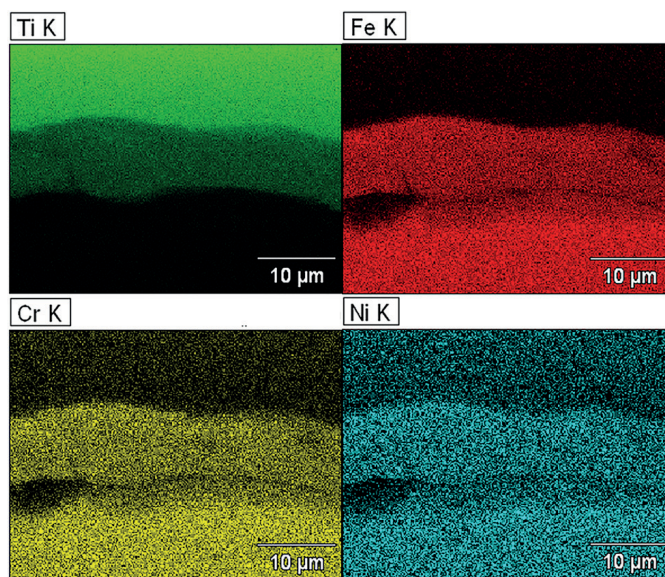

Fig. 5. Surface distribution of elements at melted area between 316L austenitic steel and titanium prior to heat treatment

Table 3

Chemical composition of melted areas in the 316L austenitic steel-titanium bond prior to heat treatment (measurement site in Fig. 4)

Measurement site	Individual element content [mass %]				
	Ti	Cr	Fe	Ni	Mo
1	49.0	8.1	36.0	5.2	1.7

Table 4

Chemical composition of melted areas in the 316L austenitic steel-titanium bond following heat treatment (measurement site in Fig. 6)

Measurement site	Individual element content [mass %]				
	Ti	Cr	Fe	Ni	Mo
1	47.2	8.8	36.7	5.3	2.0

the base and flyer plates (Fig. 6, 7). The melted zone showed titanium, iron, chromium and nickel content similar to that of the material before heat treatment (Table 4). Voids and numerous transverse cracks were also found in the area (Fig. 6). The above were caused by the differences in the values of the thermal expansion coefficient for the bonded metals. A small increase in the volume of the melted area was observed as compared to the material before heat treatment, while the location of the zones remained unchanged. Depending on the technological conditions of the explosive welding and on the materials used, the melted zone takes different shapes [1, 5, 29]. Thermodynamic factors were taken into account in the analysis of the process of melted zone formation. Kinetic energy of the flyer plate becomes transformed into heat upon collision with the base plate. Strong accumulation of energy and high pressure lead to an adiabatic increase in the temperature and melting of the ma-

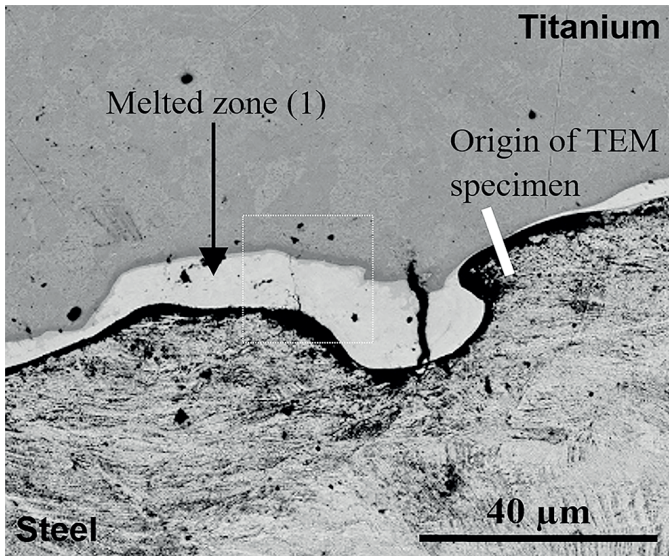

Fig. 6. Microstructure of the melted area between 316L austenitic steel and titanium following heat treatment, (1) – site of microanalysis of bond chemical composition (Table 4). White frame – analysis area for surface distribution of elements

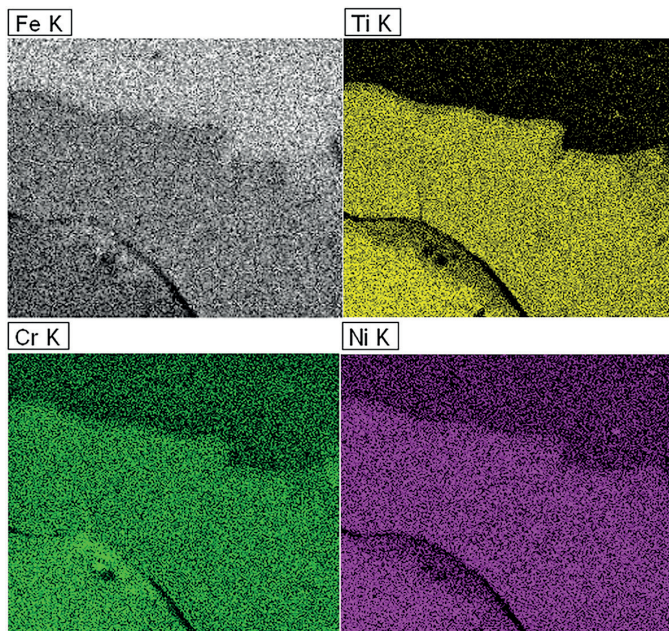

Fig. 7. Surface distribution of elements at bond area between 316L austenitic steel and titanium following heat treatment

materials within the joint. The high cooling rate results in a high degree of quench annealing in the melted zone (10^5 – 10^7 K) and in a high rate of crystallization.

The transmission electron microscopy examinations of bond microstructure enabled identification of the melted zone. The zone was found in the joints both before and after heat treatment. No voids or cracks were identified in the area. The melted zone was formed all over the bonding line. Microstructural investigations of the joint prior to heat treatment revealed that the melted zone between the titanium and steel was heterogeneous,

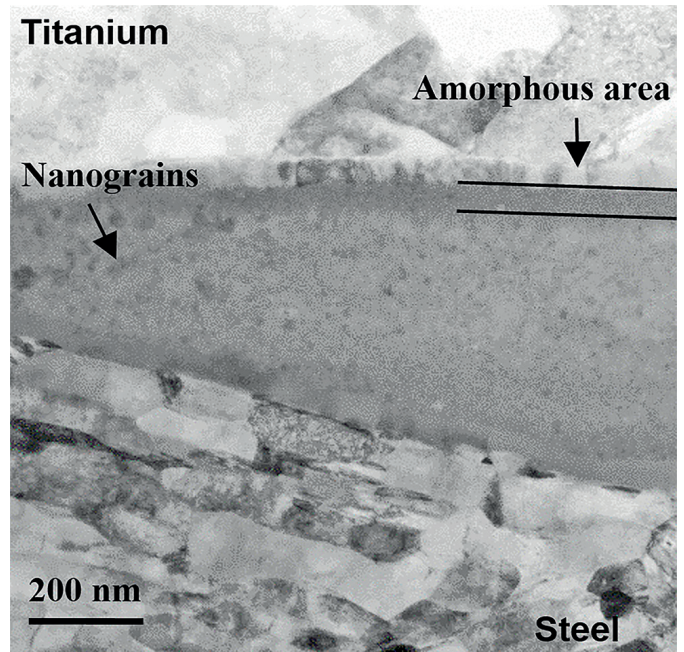

Fig. 8. Microstructure of the bond area between 316L austenitic steel and titanium prior to heat treatment

with an average thickness of 330 nm (Fig. 8). The zone did not contain micro-discontinuities such as voids or cracks. On the other hand, presence of titanium, iron, chromium and nickel was found (Fig. 9). Three areas may be distinguished in the

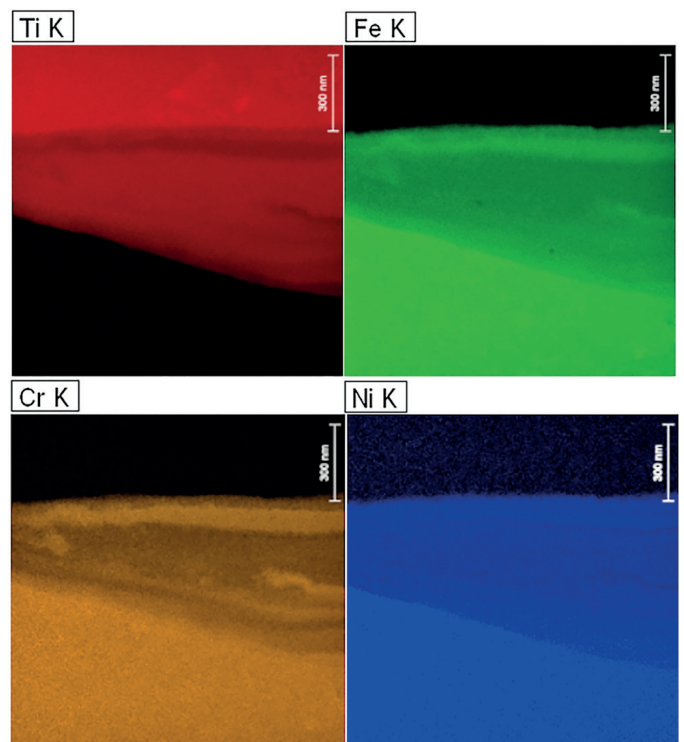

Fig. 9. Surface distribution of elements at bond area between 316L austenitic steel and titanium prior to heat treatment

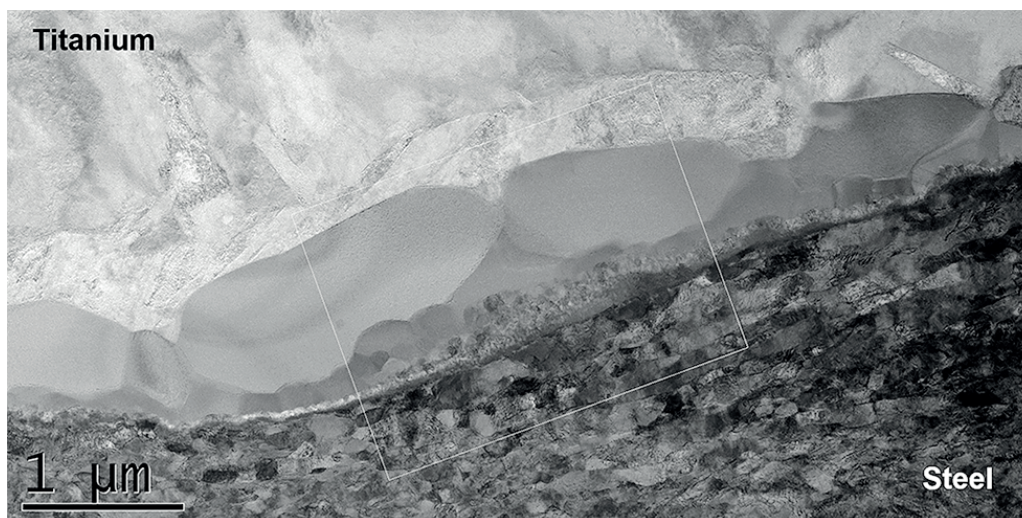

Fig. 10. Microstructure of the bond area between 316L austenitic steel and titanium following heat treatment

melted zone. The first one, on the steel side, is characterized by nanograin microstructure. Another layer is an amorphous material with an increased content of iron and chromium. The melted zone area adjacent to the titanium is composed of a polycrystalline material. The narrow area of the zone is due to the nature of the explosive welding process. It is produced as a result of diffusion of elements during bond formation. It also demonstrates the thermodynamic mechanism of bond formation. It has been assumed that the melted zone is created due to the dispersion of kinetic energy from the collision and the presence of high pressure. This leads to an adiabatic rise in the temperature of gases exposed to high pressure between the plates and the resulting melting of the sheets within the joint area. Diffusion occurs within a short period and atoms of alloy elements diffuse at a small distance into the bonded materials. The fact that the melted zone penetrates deeper into the titanium is due to diffusivity of this metal being higher than that of austenitic steel.

Following heat treatment (Fig. 10), the joint revealed thick-grain microstructure of the melted zone, as compared to the fine grain microstructure prior to heat treatment. The zone is located at the joint line on the titanium side and four areas may be distinguished. At the base of austenitic steel there is the first area of the melted zone, characterized by amorphous microstructure. A higher content of chromium was also found in

this area (Fig. 11). The second area is formed of material with highly refined grains. Another layer is a polycrystalline material with a higher nickel content. The last area, ca. 600 nm thick, has equiaxial grains and contains both titanium and steel. The penetration of the melted zone into the titanium side results from the high diffusivity of this metal as compared to austenitic steel.

3.2. Fatigue behaviors. Fatigue tests employing three-point bending tests with cyclic loads were conducted to determine the effect of microstructure morphology on fatigue life of the plates. Analysis of the results indicates an adverse effect of heat treatment on fatigue life of the plated material. A lower number of cycles before damage of the material was obtained across the whole range of stress values (Fig. 12). It has been established that the reduced fatigue life results from the increased relative volume of intermetallic precipitates in the melted zone.

3.3. Fracture surface analysis. Fractographic examinations of ruptures enabled determining the effect of heat treatment on crack propagation in clad materials. It was also possible to establish the effect of intermetallic precipitates within the joint on the propagation of the main crack. The crack initiation point was always located in the titanium. Moreover, delamination of joints was observed. Austenitic steel underwent plastic deformation but with no cracks.

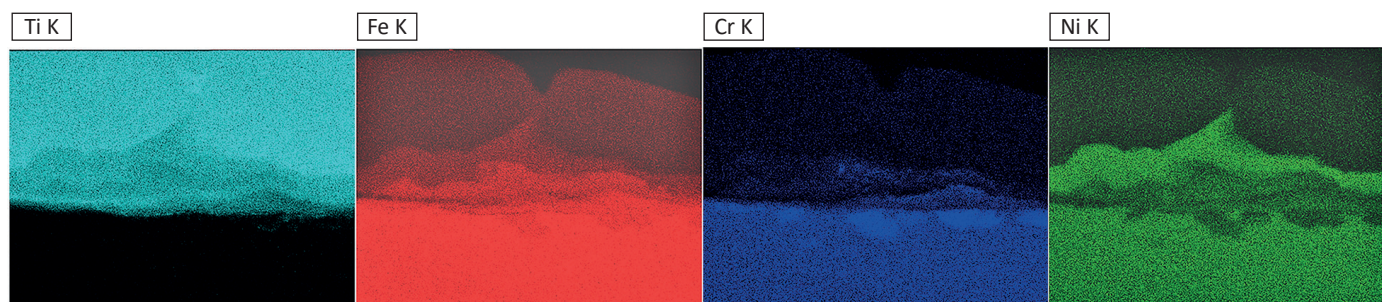

Fig. 11. Surface distribution of elements at bond area between 316L austenitic steel and titanium following heat treatment

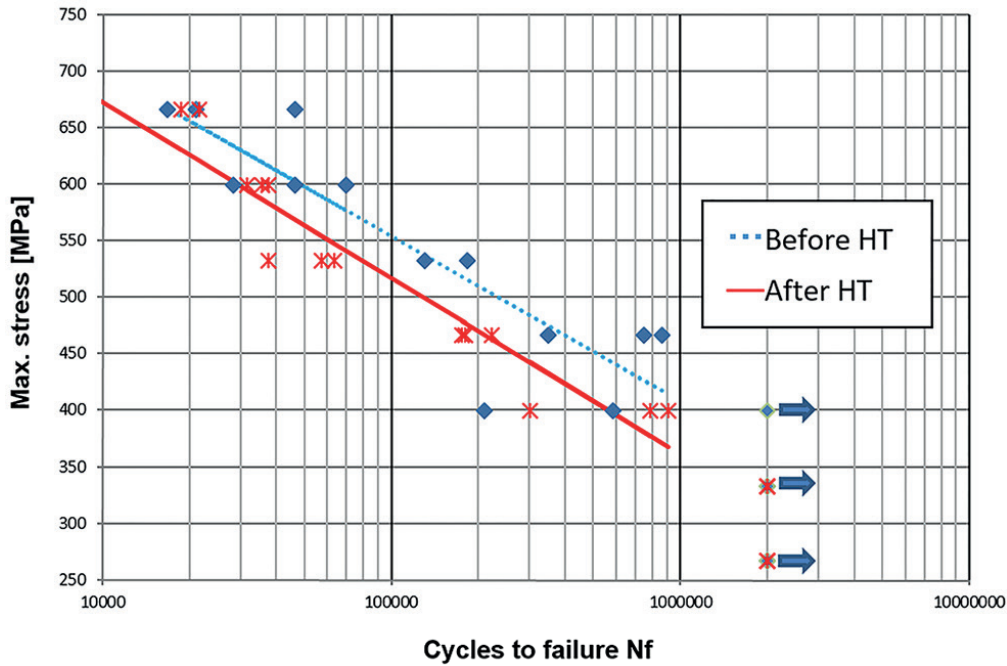

Fig. 12. Wöhler graph for samples prior to and following heat treatment

The propagation of the crack in each of the plates, both before and after heat treatment, always started in one of the corners on the titanium side. It needs to be pointed out that the edges of the samples were rounded to avoid stress concentration. In the vicinity of the crack origin site, the rupture is brittle (Fig. 13.1). A plastic rupture was found in the crack propagation zone prior to crack origination. Secondary cracks, forming under high stress, were also identified in this zone. Faults between these cracks form a characteristic rupture, a sculpture of ‘rivers’ (Fig. 13.2) and fatigue striation (Fig. 13.3). Behind the river basin, there is a zone that cracks last (Fig. 13.4). At

a larger distance from the crack peak, in this zone, the effect of the joint on the propagation of the main crack was found. Delamination of the joint is observed for any number of cycles until damage. Delamination of the heat-treated joint is caused by shearing stresses in the joint and weakness caused by the presence of the melted zone. Heat treatment did not result in any change in the nature of crack initiation in the materials. In this case, the fatigue crack also propagated by means of microcracks joining. Within the titanium joint, only a plastic rupture is found after heat treatment. Heat-treated joints, regardless of whether propagation was wavy or flat, showed total delamination.

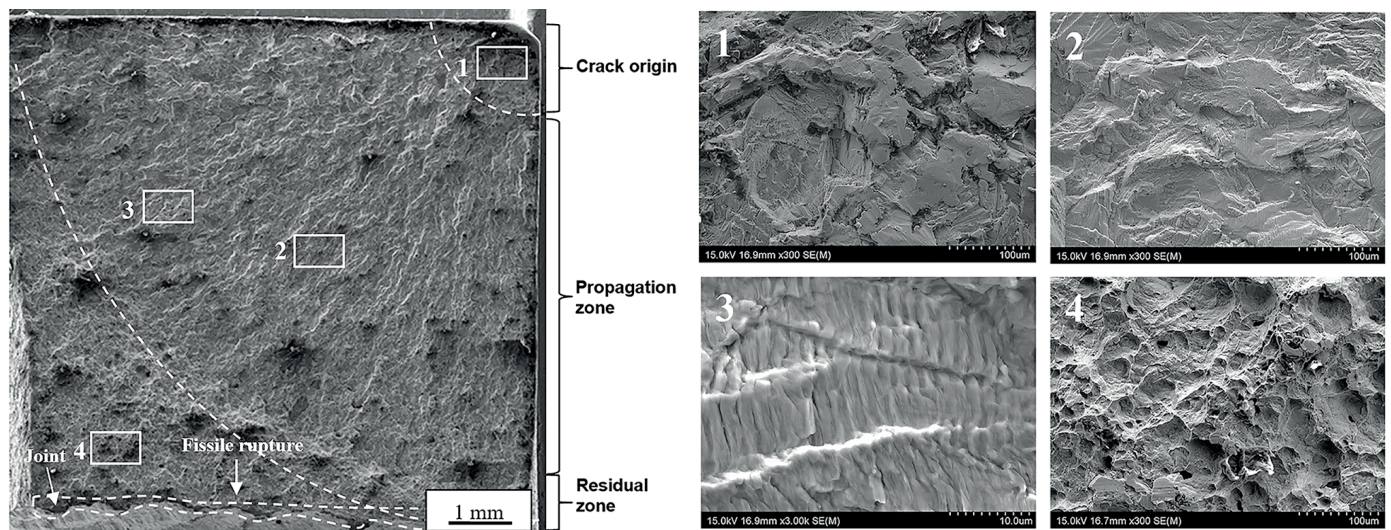

Fig. 13. Image of rupture surface in titanium after three-point bending tests of the titanium-steel bond (a), and characteristic features (b): 1. crack origin, 2. propagation zone, 3. fatigue striations, 4. failure zone

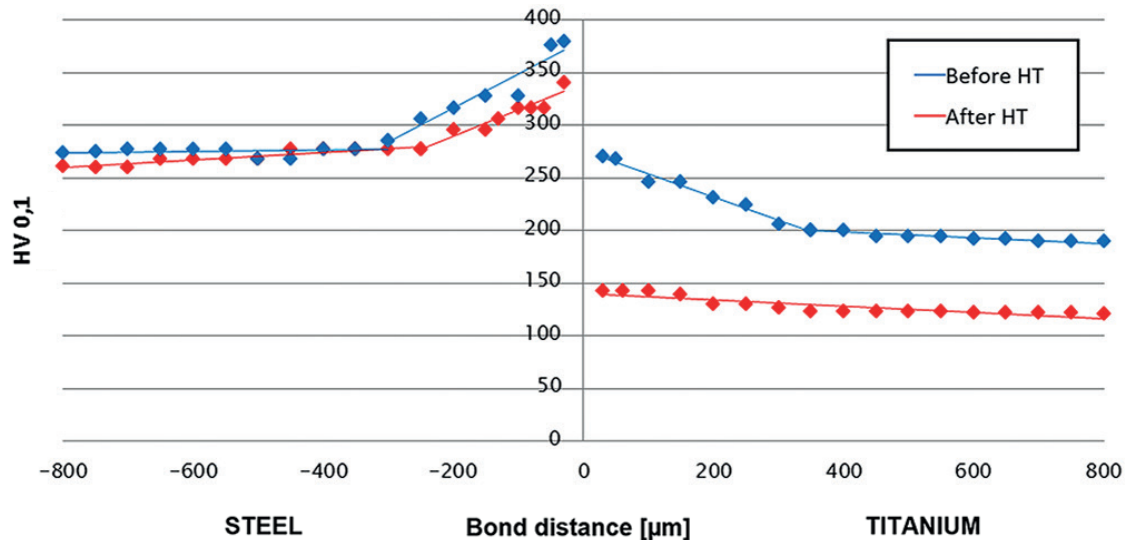

Fig. 14. Distribution of hardness of the austenitic steel-titanium bond prior to and following heat treatment

3.4. Microhardness. Joint area prior to heat treatment is harder than areas deeper into the clad and base material (Fig. 14). The study found that before heat treatment the material contained a zone of local strengthening, which spread from the joint limit to a distance of ca. 300 μm into the steel. The material showed maximum hardness at the joint limit zone ($HV_{0.1} = 376$).

The bond zone was found to be harder than the material at baseline, before explosive welding. Kahraman and Gülenç demonstrated that a higher mass of the explosive directly correlated with an increase in the joint hardness [40]. This effect is due to strong deformation of the surface layer of the sheets as a result of high collision impact. At a distance larger than 300 μm from the joint into the steel, the hardness is equal to that of the baseline material. This means that the force with which the sheets collide is not high and it does not strengthen the bonded materials at a larger distance from the joint.

Hardness measurements have also revealed that heat treatment does not completely eliminate the effects of steel strengthening, which manifests itself by only a slight hardness reduction in the area adjacent to the joint. In the titanium, on the other hand, heat treatment leads to a decrease in hardness during the recovery and recrystallization process and to obtaining a homogeneous microstructure.

4. Conclusions

The use of modern electron microscopy technology for microstructure investigations enabled studying the bond to reveal the large change in phase morphology after heat treatment.

The morphology of the titanium-steel bond differs from those of the clad and base materials. Consequently, a melted zone may be distinguished within the bond. It is formed as a result of plastic deformation of materials under the influence of high temperature, which increases the contact surface within the bonded materials volume. This intensifies the processes of

adhesion, diffusion and recrystallization occurring as a result of explosive welding.

The bond microstructure is characterized by the presence of melted areas containing titanium and alloy elements of the steel, serving as the base material. The melting is formed due to conversion of kinetic energy into heat at the time of the explosion, resulting in melting of the material microvolume within the bond area. It also increases the diffusion of alloy elements and accelerates the crystallization process: crystals of metastable phases are formed in the melted zone.

Heat treatment leads to increased relative volume of intermetallic phases: elements of the melted zone microstructure and melted areas. They in turn reduce the fatigue strength of the clad material.

The study results suggest that the acquired knowledge may be used to develop appropriate conditions for the recrystallization process leading to a reduction of stress in the joint.

Acknowledgements. This work was supported by the university grant RMN 726/2017 and National Centre for Research and Development as part of Project NR-15-0038-10/2010.

REFERENCES

- [1] J. Song, A. Kostka, M. Veehmayer, and D. Raabe, "Hierarchical microstructure of explosive joints: Example of titanium to steel cladding", *Mat. Sci. Eng. A-Struct.* 528, 2641–2647 (2011).
- [2] H. Dyja, A. Maranda, and R. Trąbiński, *Technologie wybuchowe w inżynierii materiałowej*, Wydawnictwo Wydziału Metalurgii Inżynierii Materiałowej Politechniki Częstochowskiej, Częstochowa, 2001.
- [3] D.M. Fronczek, R. Chulist, L. Litynska-Dobrzynska, G.A. Lopez, A. Wierzbička-Miernik, N. Schell, Z. Szulc, and J. Wojewoda-Budka, "Microstructural and Phase Composition Differences Across the Interfaces in Al/Ti/Al Explosively Welded Clads", *Metall. Mater. Trans. A* 48 (9), 4154–4165 (2017).

- [4] M. Blicharski, *Inżynieria powierzchni*, Wydawnictwo WNT, Warszawa, 2012.
- [5] A. Klimpel, *Napawanie i natryskiwanie cieplne*, Wydawnictwo WNT, Warszawa, 2000.
- [6] C. Senderowski, *Żelazowo-aluminiowe intermetaliczne systemy powłokowe uzyskiwane z naddźwiękowego strumienia metalizacyjnego*, BEL Studio, Warszawa, 2015.
- [7] S. Ditttrick, V.K. Balla, S. Bose, and A. Bandyopadhyay, “Wear performance of laser processed tantalum coatings”, *Mater. Sci. Eng. C Mater. Biol. Appl.* 31 (8), 1832–1835 (2011).
- [8] B. Song, K.T. Voisey, and T. Hussain, “High temperature chlorine induced corrosion of Ni50Cr coating: HVOLF, HVOGF, cold spray and laser cladding”, *Surf. Coat. Tech.* 337, 357–369 (2018).
- [9] H. Xiao, Z. Qi, C. Yu, and C. Xu, “Preparation and properties for Ti/Al clad plates generated by differential temperature rolling”, *J. Mater. Process. Tech.* 249, 285–290 (2017).
- [10] O. Grydin, G. Gerstein, F. Nürnberger, M. Schaper, and V. Danchenko, “Twin-roll casting of aluminum–steel clad strips”, *J. Manuf. Process.* 15 (4), 501–507 (2013).
- [11] K. Topolski, P. Wiciński, Z. Szulc, A. Galka, and H. Grabacz, “Progress in the characterization of explosively joined Ti/Ni bimetal”, *Mater. Design* 63, 479–487 (2014).
- [12] I.N. Maliutina, V.I. Mali, K.A. Skorokhod, and A.A. Bataev, “Effect of Heat-Treatment on the Interface Microstructure of Explosively Welded Stainless Steel – Bronze Composite”, *Appl. Mech. Mater.* 698, 495–500 (2015).
- [13] T.Z. Blazynski, *Explosive Welding, Forming and Compaction*, Applied Science, London, 1983.
- [14] F. Findik, “Recent developments in explosive welding”, *Mater. Design* 32, 1081–1093 (2011).
- [15] L. Cizek, D. Ostroushko, E. Mazancova, and M. Wachowski, “Structure and Properties of Sandwich material Steel Cr13Ni10 + Ti after Explosive Cladding”, *Metallurgical Journal* 62, 6 (2009).
- [16] R. Kosturek, M. Najwer, P. Nieslony, and M. Wachowski, “Effect of Heat Treatment on Mechanical Properties of Inconel 625/Steel P355NH Bimetal Clad Plate Manufactured by Explosive Welding”, *Lect. N. Mech. Eng.*, 681–686 (2018).
- [17] Y. Kaya and N. Kahraman, “An investigation into the explosive welding/cladding of Grade A ship steel/AISI 316L austenitic stainless steel”, *Mater. Design* 52, 367–372 (2013).
- [18] I.A. Bataev, T.S. Ogneva, A.A. Bataev, V.I. Malia, M.A. Esikova, D.V. Lazurenkoa, Y. Guo, and A.M. Jorge Junior, “Explosively welded multilayer Ni–Al composites”, *Mater. Design* 88, 1082–1087 (2015).
- [19] R. Ma, Y. Wang, J. Wu, and M. Duan, “Investigation of microstructure and mechanical properties of explosively welded ITER-grade 316L(N)/CuCrZr hollow structural member”, *Fusion Eng. Des.* 93, 43–50 (2015).
- [20] W. Babul, *Odkształcanie metali wybuchem*, Wydawnictwo WNT, Warszawa, 1980.
- [21] S. Saravanan and K. Raghukandan, “Thermal kinetics in explosive cladding of dissimilar metals”, *Sci. Technol. Weld. Jo.* 17 (2), 99–103 (2012).
- [22] M. Prazmowski, D. Rozumek, and H. Paul, “Static and fatigue tests of bimetal Zr-steel made by explosive welding”, *Eng. Fail. Anal.* 75, 71–81 (2017).
- [23] L. Liu, Y.F. Jia, and F.Z. Xuan, “Gradient effect in the waved interfacial layer of 304L/533B bimetallic plates induced by explosive welding”, *Mat. Sci. Eng. A-Struct.* 704, 493–502 (2017).
- [24] M. Wachowski, M. Gloc, T. Ślęzak, T. Płociński, and K.J. Kurzydłowski, “The Effect of Heat Treatment on the Microstructure and Properties of Explosively Welded Titanium-Steel Plates”, *J. Mater. Eng. Perform.* 26, 945–954 (2017).
- [25] M. Gloc, H. Słomińska, and Ł. Ciupiński, “Hydrogen Influence on Microstructure and Properties of Novel Explosive Welded Corrosion Resistant Clad Materials”, *Defect Diffus. Forum* 382, 167–172 (2018).
- [26] R. Kacar and M. Acarer, “An investigation on the explosive cladding of 316L stainless steel-din-P355GH steel”, *J. Mater. Process. Tech.* 152 (1), 91–96 (2004).
- [27] M. Laurent, R. Estevez, D. Fabrègue, and E. Ayax, “Thermo-mechanical fatigue life prediction of 316L compact heat exchanger”, *Eng. Fail. Anal.* 68, 138–149 (2016).
- [28] B.J. Jin, J.P. Lee, M.H. Park, T.J. Yun, Y.H. Song, and I.S. Kim, “A Study on Forming for Plate-Type Heat Exchangers of the Ti Material”, *Procedia Engineer.* 174, 171–178 (2017).
- [29] A.A. Berdychenko, L.B. Pervukhin, and O.L. Pervukhina, “Evolution of Titanium structure in the zone of the joint formed by explosive welding”, *Met. Sci. Heat. Treat.* 51, 9–10 (2009).
- [30] Y. Kaya, N. Kahraman, A. Durgutlu, and B. Gulenc, “Investigation of the Microstructural, Mechanical and Corrosion Properties of Grade A Ship Steel-Duplex Stainless Steel Composites Produced via Explosive Welding”, *Metall. Mater. Trans. A* 48 (8), 3721–3733 (2017).
- [31] N. Kahraman, B. Gulenc, and F. Findik, “Joining of titanium/stainless steel by explosive welding and effect on interface”, *J. Mater. Process. Tech.* 169, 127–133 (2005).
- [32] H. Liqing, L. Guobiao, W. Zidong, Z. Hong, F. Feng, and Y. Long, “Study on Corrosion Resistance of 316L Stainless Steel Welded Joint”, *Rare Metal. Mat. Eng.* 39 (3), 393–396 (2010).
- [33] M. Tršo, M. Benák, M. Turňa, and P. Nesvadba, “Structural Stability of Composite Materials Prepared by Explosion Welding After Their Heat Treatment”, *Defect Diffus. Forum* 297–301, 1171–1176 (2010).
- [34] R. Kacar and M. Acarer, “An investigation on the explosive cladding of 316L stainless steel-din-P355GH steel”, *J. Mater. Process. Tech.* 152 (1), 91–96 (2004).
- [35] S.A.A. Akbari Mousavi, S.T.S. Al-Hassani, and A.G. Atkins, “Bond strength of explosively welded specimens”, *Mater. Design* 29 (7), 1334–1352 (2008).
- [36] W. Walczak, “Characteristic features of joints in some explosively welded metals and alloys”, *Welding International* 12, 953–958 (1998).
- [37] W. Babul and S. Ziemba, *Materiały wybuchowe w technologicznych procesach obróbki tworzyw*, Państwowe Wydawnictwo Naukowe, Warszawa, 1972.
- [38] W. Walczak, *Zgrzewanie wybuchowe metali i jego zastosowania*, Wydawnictwo WNT, Warszawa, 1989.
- [39] A.A. Ezra, *Principles and practices of explosive metalworking*, Industrial Newspaper, London, 1973.
- [40] A. Nobili, T. Masri, and M. C. Lafont, *Recent Developments In Characterization of a Titanium-Steel Explosion Bond Interface*, Proceedings of Reactive Metals in Corrosive Applications Conference, Albany OR, 1999.
- [41] N. Kahraman and B. Gülenç, “Microstructural and mechanical properties of Cu-Ti plates bonded through explosive welding process”, *J. Mater. Process. Tech.* 169 (1), 67–71 (2005).