

Projective filtering of time-aligned beats for foetal ECG extraction

M. KOTAS*

Institute of Electronics, Division of Biomedical Electronics, Silesian University of Technology,
16 Akademicka St., 44-100 Gliwice, Poland

Abstract. Extraction of the foetal electrocardiogram from single-channel maternal abdominal signals without disturbing its morphology is difficult. We propose to solve the problem by application of projective filtering of time-aligned ECG beats. The method performs synchronization of the beats and then employs the rules of principal component analysis to the desired ECG reconstruction. In the first stage, the method is applied to the composite abdominal signals, containing maternal ECG, foetal ECG, and various types of noise. The operation leads to maternal ECG enhancement and to suppression of the other components. In the next stage, the enhanced maternal ECG is subtracted from the composite signal, and this way the foetal ECG is extracted. Finally, the extracted signal is also enhanced by application of projective filtering. The influence of the developed method parameters on its operation is presented.

Key words: principal component analysis; projective filtering; foetal ECG.

1. Introduction

The first demonstration of the foetal electrocardiogram (FECG) was carried out in 1906 by Cremer [1]. However, this achievement was ignored for more than two decades. Later many experiments were performed with the invasive techniques of the FECG recording. In the seventies first attempts appeared with the noninvasive techniques. They were based on the signals recorded from the maternal abdominal wall. However, such signals contain not only the foetal ECG, but primarily the maternal electrocardiogram (MECG) and various types of contaminations. Since the maternal signal is, in most cases, of much higher level than the foetal one, the first operation which should be performed is the maternal electrocardiogram (MECG) suppression. About 20–30 years ago the problem was a challenge. With the decades of experiments, many methods of maternal ECG suppression were developed.

Two the most important approaches to the problem can be distinguished. The first is based on the analysis of multi-channel signals. In [2] an application of adaptive filtering was described, with a few thoracic signals at the reference inputs, combined to cancel the maternal ECG in the abdominal signals. In [3] a weighted addition of four or more abdominal signals was calculated to suppress the maternal ECG. A set of important techniques was based on the application of singular value decomposition to the separation of the maternal and the foetal source signals [4]. Application of not only the second (as in [4]), but also of higher order statistical conditions of independence allowed to achieve a great progress in the accomplishment of the separation task [5]. Since the work [5] appeared, many different algorithms of blind source separation have been applied to the problem of FECG extraction [6–8]. All the mentioned techniques utilize the redundancy of the multichannel ECG recordings. Therefore, in most cas-

es, at least three or four signals are required to achieve the successful extraction of the foetal ECG [9].

The second approach utilizes the approximate repeatability of the ECG to achieve the goal of separation in single-channel signals. Construction of the MECG beat template and subtraction of this template from the analyzed signal in the places where individual beats occur is a simple yet effective solution of the problem [10]. A similar goal can be achieved when singular value decomposition of the synchronized maternal beats is performed to find the template which should be subtracted [11]. The single-channel techniques can effectively be applied in systems for long term foetal heart rate monitoring. They were not reported, however, as the techniques which can be applied to FECG extraction for the purpose of the signal morphology analysis. This results from the fact that these techniques require prior high-pass filtering with a relatively high cutoff frequency to suppress the low amplitude parts of the maternal ECG beats, and the operation of subtraction is performed mostly to suppress the maternal QRS complexes.

A progress in the field of nonlinear dynamics resulted in the development of useful tools for signal processing, such as the method of nonlinear state-space projections (NSSP) which was successfully applied to ECG signal enhancement [12], and to foetal ECG extraction from single channel signals. The method was reported as a tool which allows extraction of the foetal signal without disturbing its morphology [13]. However, the extremely high computational costs of NSSP made the method be rather theoretical than practical tool. Modifying the method and developing the method of projective filtering of time-aligned ECG beats (PFTAB) [14] can have more practical meaning. Like NSSP the PFTAB method allows for enhancement of the dominating maternal ECG and for suppression of the other components of an abdominal signal. As a result, after subtraction of the enhanced maternal ECG, the method leads to extraction of the foetal electrocardiogram.

*e-mail: mkotas@polsl.pl

The rest of the paper is organized as follows: Section 2 describes the method of nonlinear state-space projections; Section 3 the method of projective filtering of time-aligned beats; Section 4 the system for foetal ECG extraction from single-channel signals; Section 5 discusses the influence of projective filtering parameters on the results of the extraction; Section 6 is devoted to final conclusions.

2. Nonlinear state-space projections for ECG noise reduction

There has for several years been discernible an increase of interests in applications of nonlinear dynamics methods to processing and analyzing of real world signals. The progress in this field has inspired development of useful tools, such as the method of nonlinear state-space projections (NSSP) [12,13].

The method was developed for suppression of the measurement noise contaminating deterministically chaotic signals [15]. Considerations concerning its applicability to ECG processing can be found in [12]. The main steps performed by the method are as follows.

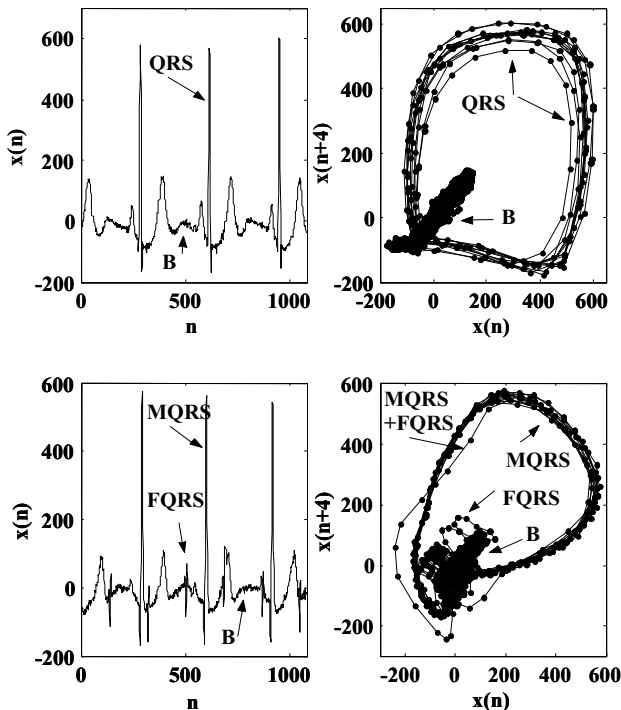

Fig. 1. State-space trajectories reconstructed by application of the embedding operation; the successive points are connected to show the trajectory evolution. Since high dimensional embedding cannot be shown graphically, a two-dimensional trajectory has been presented (obtained for $m = 2$, $\tau = 4$) to give a preliminary impression of higher dimensional structure. The upper plots were obtained for a high quality ECG from the MIT-BIH database; the lower for a complex maternal abdominal signal, containing both maternal and foetal ECG

1. Reconstruction of the state-space representation of the observed noisy signal is achieved (Fig. 1) by application of the Takens embedding operation where a point in the constructed space is a vector

$$\mathbf{x}^{(n)} = [x(n), x(n + \tau), \dots, x(n + (m - 1)\tau)]^T \quad (1)$$

where $x(n)$ is the processed signal, τ is the time lag ($\tau = 1$ appeared advantageous in [12–14] and will be used in this study), m is the embedding dimension.

2. Correction of each individual point $\mathbf{x}^{(n)}$ of the trajectory.
3. Conversion of the corrected trajectory points back into one-dimensional signal.

An algorithm of a trajectory point correction (performed by locally linear projections) is as follows.

For each point of the trajectory, a small neighbourhood $\Gamma^{(n)}$ is constructed, composed of the trajectory points which are close to the considered one

$$\Gamma^{(n)} = \left\{ k \mid \|\mathbf{x}^{(k)} - \mathbf{x}^{(n)}\| < \varepsilon \right\} \quad (2)$$

where $\|\cdot\|$ denotes the Euclidean distance, ε is the assumed maximal distance between the considered points. It is usually required [12] that the number of neighbourhood points be higher than the assumed minimal value k_{\min} , which often results in the necessity to enlarge the radius ε in some regions of the embedding-space trajectory (in Fig. 1 it is visible that the density of points is different in different parts of the trajectory, and a large radius should be applied for the QRS loop to cover the required number of points).

Within each neighbourhood a local mean $\bar{\mathbf{x}}^{(n)}$ is computed and a covariance matrix of the deviations from the mean, which is defined as

$$\mathbf{C}^{(n)} = \frac{1}{|\Gamma^{(n)}|} \sum_{k \in \Gamma^{(n)}} (\mathbf{x}^{(k)} - \bar{\mathbf{x}}^{(n)}) (\mathbf{x}^{(k)} - \bar{\mathbf{x}}^{(n)})^T, \quad (3)$$

where $|\Gamma^{(n)}|$ denotes the neighbourhood cardinality.

Then the transformed version of the covariance matrix is calculated $\mathbf{G}^{(n)} = \mathbf{R} \mathbf{C}^{(n)} \mathbf{R}$ (where \mathbf{R} is a diagonal penalty matrix, introduced to penalize the corrections of the first and the last coordinates in the delay window, $r_{1,1} = r_{m,m} = r$, where r is large [12], and the other diagonal entries of \mathbf{R} are equal 1).

The transformed covariance matrix undergoes eigendecomposition

$$\mathbf{G}^{(n)} = \mathbf{E}^{(n)} \mathbf{\Delta}^{(n)} \mathbf{E}^{(n)T}, \quad (4)$$

where $\mathbf{E}^{(n)} = [\mathbf{e}_1^{(n)}, \dots, \mathbf{e}_m^{(n)}]$, $\mathbf{\Delta}^{(n)} = \text{diag}(\delta_1^{(n)}, \dots, \delta_m^{(n)})$, $\delta_1^{(n)} \geq \delta_2^{(n)} \geq \dots \geq \delta_m^{(n)}$.

After the eigendecomposition the trajectory point under correction is projected into the subspace of the first q ($q < m$) principal eigenvectors

$$\mathbf{x}'^{(n)} = \bar{\mathbf{x}}^{(n)} + \mathbf{P}_q^{(n)} (\mathbf{x}^{(n)} - \bar{\mathbf{x}}^{(n)}), \quad (5)$$

where the projecting matrix is equal to the product

$$\mathbf{P}^{(n)} = \mathbf{E}_q^{(n)} \mathbf{E}_q^{(n)T}, \quad \mathbf{E}_q^{(n)} = [\mathbf{e}_1^{(n)}, \dots, \mathbf{e}_q^{(n)}]. \quad (6)$$

The projection is performed for each trajectory point. Since each sample of the processed signal occurs in m trajectory points its correction is a result of m individual corrections. It can be calculated as their average.

The penalty matrix \mathbf{R} makes the largest two eigenvectors lie in the subspace of the first and the last coordinates of the embedding space [12].

Performance of NSSP is highly dependent on the results of neighbourhood determination. The points included into a neighbourhood should belong to the same parts of ECG beats. This condition can be fulfilled for rather moderate level of noise only. When the level of noise grows, the neighbourhood determination errors limit the method's performance. Good predictability of the ECG signal within a single beat [12] (resulting from the approximate repeatability of the signal) can be exploited to overcome this problem within the confines of the presented NSSP rules. Application of a very high embedding dimension, corresponding to a relatively long time interval (e.g. 500 ms, as in [12]), ensures that most of the trajectory points will overlap a QRS complex. Because of the complex relatively high energy, the neighbours of such points will belong to approximately the same parts of a cardiac beat. Such solution, however, still raises very high computational costs of the method.

Therefore a modification was introduced [14] to overcome this problem in a more economic way: instead of the Euclidean distance between points, their position within an ECG beat was employed as a criterion for neighbourhood determination. With such a criterion, the operation of neighbourhood construction has to be performed not for all points of the state-space trajectory but for all locations within an ECG beat only. This modification allowed to split the procedure into the learning phase, which consists in ECG beats time-alignment and then local neighbourhoods and local signal subspaces determination, and the processing phase of the projective filtering.

3. Projective filtering of time-aligned ECG beats (PFTAB)

In the application considered, a preprocessing step of the operation makes use of the following techniques: linear filtering for low frequency noise suppression, QRS complex detection [16], cross-correlation function based synchronization of the detected complexes. This operation produces a set of fiducial marks $\{r_k \mid k = 1, 2, \dots, K + 1\}$ corresponding to the same position within the respective detected QRS complexes. Projective filtering operates in a blockwise manner, on signal segments of the assumed length, which should be sufficiently high to enable effective accomplishment of the first, learning phase of the method. The parameter K is equal to the number of ECG beats in a segment. Such approach was applied in this study. An alternative one is based on specifying the required number K . In both cases, however, when longer ECG records are to be processed, they should be divided into successive segments (possibly overlapping) according to the chosen approach.

3.1. The learning phase of projective filtering. The learning phase of the method consists in an application of principal component analysis (PCA [17]) to the construction of local signal subspaces (LSS) for each position j within a beat. Here the term local refers to the position within a beat, but it is assumed that such a position determines the points localization in the embedding space as well.

We assume that each beat begins b samples before its fiducial mark and ends $b + 1$ samples before the fiducial mark of the next beat. In order to facilitate construction of local signal subspaces (LSS), we store the beats in an auxiliary matrix \mathbf{T} . Each beat occupies one column of $\mathbf{T} = [\mathbf{t}_k]_{k=1}^{k=K}$. The number of rows (which will be denoted as I) depends on the length of the longest beat (RR_{\max}). It must be large enough to allow construction of a signal subspace for $j = RR_{\max}$. Thus we set $I = RR_{\max} + (m - 1)$, and all the beats in \mathbf{T} are extended to this length. A few extension methods have been considered in the literature; we apply the method of zero order extension that extends a beat by repeating its last sample [18].

Time-alignment of the beats enables easy determination of LSS corresponding to the respective positions within a beat. To this end, for each j ($1 \leq j \leq RR_{\max}$) we select a submatrix of \mathbf{T}

$$\mathbf{T}^{(j)} = [\mathbf{t}_k^{(j)}]_{k=1}^{k=K} = [t_{i,k}^{(j)}]_{i=m, k=1}^{i=m, k=K}, \text{ where } t_{i,k}^{(j)} = t_{i-1+j,k} \quad (7)$$

containing the vectors $\mathbf{t}_k^{(j)}$, which correspond to the synchronized trajectory points. We form a local neighbourhood $\Gamma^{(j)}$ by rejecting the assumed fraction c_R of the most distant points.

After determination of a local neighbourhood, a local mean $\bar{\mathbf{t}}_k^{(j)}$ is computed and a covariance matrix of the deviations from the mean

$$\mathbf{C}^{(j)} = \frac{1}{|\Gamma^{(j)}|} \sum_{k \in \Gamma^{(j)}} \left(\mathbf{t}_k^{(j)} - \bar{\mathbf{t}}^{(j)} \right) \left(\mathbf{t}_k^{(j)} - \bar{\mathbf{t}}^{(j)} \right)^T. \quad (8)$$

In projective filtering of time-aligned ECG beats we desisted the concept of penalizing the corrections of the first and the last coordinates of the embedding space vectors. Thus, a local signal subspace corresponding to the j th neighbourhood can be calculated by eigendecomposition of the covariance matrix $\mathbf{C}^{(j)}$. Similarly as in (6), the projecting matrix is given by

$$\mathbf{P}^{(j)} = \mathbf{E}_q^{(j)} \mathbf{E}_q^{(j)T}, \quad \mathbf{E}_q^{(j)} = [\mathbf{e}_1^{(j)}, \dots, \mathbf{e}_q^{(j)}] \quad (9)$$

where $\mathbf{e}_i^{(j)}$ $i = 1, 2, \dots, q$ are the eigenvectors of $\mathbf{C}^{(j)}$.

Determination of the projecting matrices $\mathbf{P}^{(j)}$ for the respective positions within an ECG beat ends the learning phase of the method.

3.2. The processing phase of projective filtering. The processing phase consists of the following steps.

Determination of a position j within a beat, the point under correction belongs to

$$\begin{aligned}
 & \forall \\
 & r_k - b \leq n < r_{k+1} - b \quad j(n) = \\
 & \begin{cases} n - r_k + b + 1, & n - r_k + b < RR_{\max} \\ RR_{\max}, & \text{elsewhere} \end{cases} \quad (10)
 \end{aligned}$$

Projecting the considered point into the corresponding signal subspace

$$\mathbf{x}'(n) = \bar{\mathbf{t}}^{(j(n))} + \mathbf{E}_q^{(j(n))} \mathbf{E}_q^{(j(n)T)} (\mathbf{x}^{(n)} - \bar{\mathbf{t}}^{(j(n))}). \quad (11)$$

The n th sample of the processed signal occurs in m trajectory points, as the l th entry $x_l^{(n-l+1)}$ of the vector $\mathbf{x}^{(n-l+1)}$. Averaging the results of the respective points projection according to the formula

$$x'(n) = \frac{1}{m} \sum_{l=1}^m x_l^{(n-l+1)} \quad (12)$$

ends the processing phase of projective filtering. More detailed description of the method, and a comprehensive study of its operation can be found in [14].

4. Application of projective filtering to foetal ECG extraction from single-channel signals

The operation is performed according to the block diagram in Fig. 2. The input signal frequency band depends on the system application. If the system is constructed to detect the foetal QRS complexes for heart rate determination only, a relatively narrow passband of the analogue filters can be applied. The experiments described in [19,20] show, however, that the left cutoff frequency of the passband should not be higher than 10 Hz, and the right one much lower than 60 Hz to cover the spectrum of the foetal QRS complexes. With such parameters of the passband, the analogue amplifiers spoil the morphological information of the ECG signals. If this information is of interest, the left cutoff frequency of the amplifiers should not be much higher than 0.1 Hz and the right one lower than 100 Hz. Locating the electrodes on the maternal abdomen, we obtain signals which contain the maternal ECG, the wide-band EMG noise, the low frequency baseline wandering, the 50 Hz powerline interference, and the signal of the primary interest – the foetal ECG. To simplify the problem, we assume that the input signal is measured by application of the electronic amplifiers with high common mode rejection ratio to eliminate the powerline interference. Still, a variety of contaminating signals are to be suppressed. Although the low cutoff frequency of the analogue filters should not be higher than 0.1 Hz, because of the filters nonlinear phase response, the digital high-pass filters with linear phase response can be applied in block B1 to suppress the low frequency contaminations. The generally accepted cutoff frequency of such filters is 1 Hz. However, with the predominant level of the considered contamination (if compared to the level of the foetal ECG) higher cutoff frequency is convenient. The output

of the filters, denoted by $x(n)$, undergoes projective filtering. The preliminary operations of maternal QRS complexes detection [16] and beats synchronization are performed in block B2. The determined positions are used in the block of projective filtering (B3). The aim of the operation is to enhance the maternal ECG by suppressing the other components of the signal. The enhanced signal ($x'(n)$) contains mostly the maternal ECG, and some residua of the EMG noise and of the foetal ECG. Subtracting this signal from $x(n)$ leads to maternal ECG suppression, and this way to foetal ECG extraction. The extracted signal, however, contains high level of EMG noise and some residua of the maternal beats. In spite of the linear filtering, performed in block B1, the level of low frequency contaminations can be considerable as well. If the signal quality is high enough for successful detection of the foetal QRS complexes (in block B4, realized by application of the method based on the normalized matched filter [20]), the extracted signal can also undergo projective filtering in block B5. As a result, the enhanced foetal ECG is obtained.

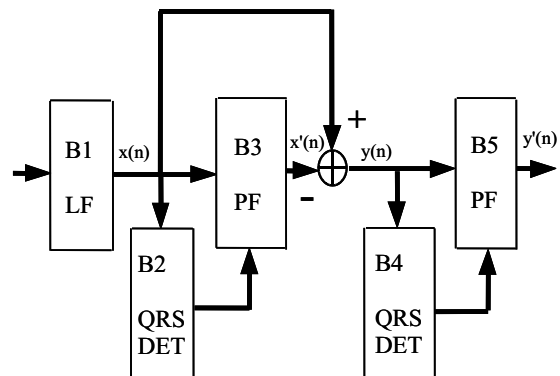

Fig. 2. Block diagram of the system for foetal ECG extraction from single-channel signals: (B1) linear filters, (B2,B4) QRS detection, (B3,B5) projective filtering

5. Results and discussion

5.1. Adjustment of the system parameters. The proposed system for foetal ECG extraction requires careful adjustment of the parameters that assure its high performance. Among the most important are the parameters of both applied projective filters: the index b pointing to where the beats stored in the matrix \mathbf{T} begin, the fraction c_R of the points rejected while local neighbourhoods are being constructed, the embedding dimension m , and the dimension q of local signal subspaces. It is also important to choose the proper length of the analyzed signal segments, and the cutoff frequency of the high-pass filter in block B1. With a few signals, satisfying the specified requirements for investigating the foetal ECG morphology, we will show the system operation, and the parameters impact on its improvement or deterioration.

Because of the extremely high level of low frequency noise in the abdominal ECG signals, we decided to use the high-pass filter with the cutoff frequency of 2 Hz in block B1. With the foetal heart rate higher than 100 beats per minute, in typical cases, this value should not disturb much the signal

Projective filtering of time-aligned beats for foetal ECG extraction

morphology [21]. In block B3 of maternal ECG enhancement the parameter b was set to 120. With the sampling frequency of the analyzed signals equal to 400 Hz, this value corresponds to the interval of 300 ms. For c_R we applied the value of 0.1 as in [14]. In [14] the length of the processed signal segment was equal to 80 s. Such value is satisfactory, but its increase is advantageous. In most experiments presented in this study, we analyzed the signal segments of about 3 minutes. After many experiments the embedding dimension $m = 60$ was chosen, corresponding to the interval of 150 ms.

The dimension q of local signal subspaces is a crucial parameter of the projective filters. In [22], where the method was applied to enhance the ECG signals prior to the measurements of the QT interval, very good results were achieved for $q = 3$. With this dimension the filter was able to reconstruct precisely the processed signal morphological variability. As a result, the method helped to raise significantly the precision of the repolarization duration measurements. In the application investigated in this paper, we face a slightly different problem. The filter not only should allow for precise reconstruction of the processed maternal ECG but, at the same time, it should be robust against the outlying observations – the foetal QRS complexes occurring in the maternal signal.

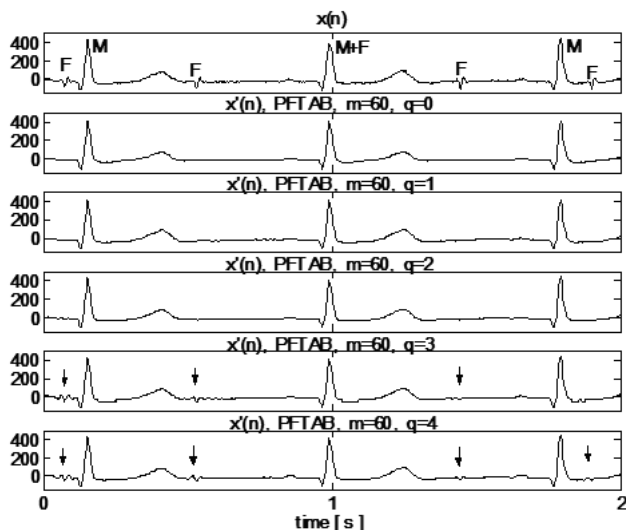

Fig. 3. The results of maternal ECG enhancement by application of projective filtering (block B3 in Fig. 3) with different dimensions of local signal subspaces. The maternal QRS complexes are marked with the letter M, the foetal with F, and the case of the maternal and the foetal complexes coincidence with M+F. The arrows indicate the clearly visible residuals of the foetal complexes

The influence of the dimension q of local signal subspaces on the operation of block B3 is illustrated in Fig. 3. The processed signal is presented in the uppermost subplot of the figure. It is the output of block B1, with low frequency contaminations suppressed. The signal is of high quality, with the foetal QRS complexes clearly visible. Projective filtering with $q = 0$ produced a repeatable maternal ECG signal, with the foetal ECG successfully suppressed (the operation is similar to time averaging). However, the deviations of the respective

maternal beats from the average one were suppressed as well. With the growth of q , the morphological variability of the maternal ECG was reconstructed more precisely, but the FECG suppression was less effective. For $q = 3$ or $q = 4$ some residua of this component are clearly discernible. It is disadvantageous because, in such cases, subtraction of the filtered signal ($x'(n)$) can lead not only to maternal ECG suppression, but to foetal ECG attenuation as well.

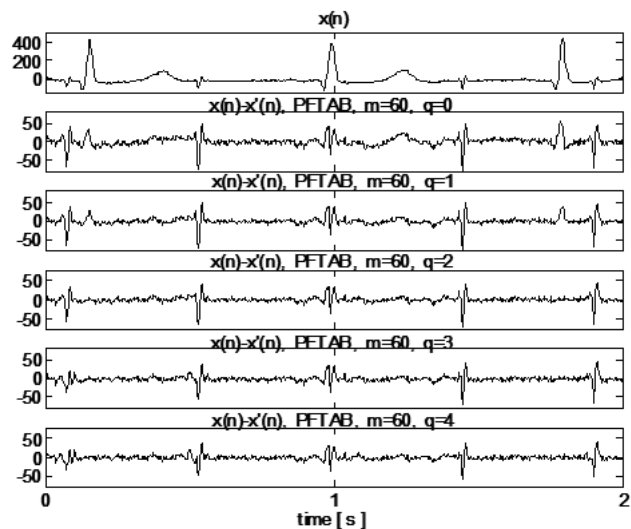

Fig. 4. The results of maternal ECG suppression by subtraction of the signals presented in Fig. 2 (obtained in block B3)

The results of the subtraction are presented in Fig. 4. For $q = 0$ there are clearly visible residua of the maternal QRS complexes. Such residua can complicate further analysis of the obtained FECG signals. However, the extracted foetal QRS complexes are of similar, relatively high amplitude, except for the one which was overlapped by the maternal complex. The overlapping caused some attenuation and deformation of the foetal complex. To decrease the residua of the maternal ECG, we need to employ projective filtering with higher dimensions of local signal subspaces. For $q > 1$ the residua are not discernible. However, for $q = 3$ and for $q = 4$ some of the foetal complexes are deformed and attenuated. These are the complexes whose residua are indicated by arrows in Fig. 3. Comparing the respective FECG traces, taking into account the efficiency of the maternal ECG suppression, and the quality of the extracted foetal QRS complexes, one can notice that the best compromise was achieved for $q = 2$. Nevertheless, in low amplitude parts of the maternal ECG it is advantageous to apply $q = 0$ to cause the most effective suppression of the foetal ECG and, in consequence, the best quality of the signal extracted by the operation of subtraction.

The problem is even more important if the level of the foetal ECG is higher. In such cases, the local signal subspaces constructed in low amplitude parts of the maternal ECG can be dominated by the directions corresponding to the foetal ECG. As a result, the foetal QRS complexes can hardly be suppressed in block B3, which leads to their attenuation by the operation of subtraction. The problem is illustrated in Fig. 5.

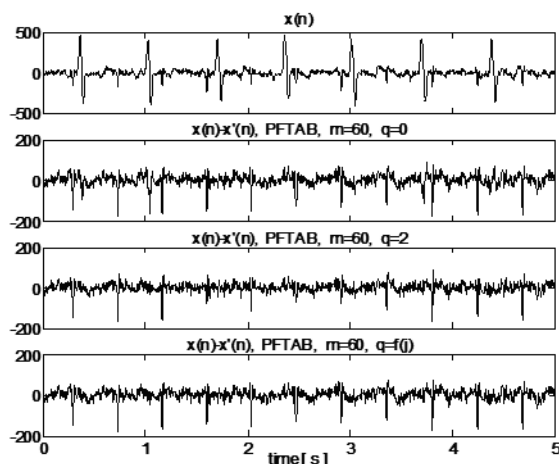

Fig. 5. The results of maternal ECG suppression for a signal with high level of the foetal ECG. The lowest picture presents the results obtained when different dimensions of local signal subspaces were applied. It corresponds to Fig. 6, where the dimensions are presented

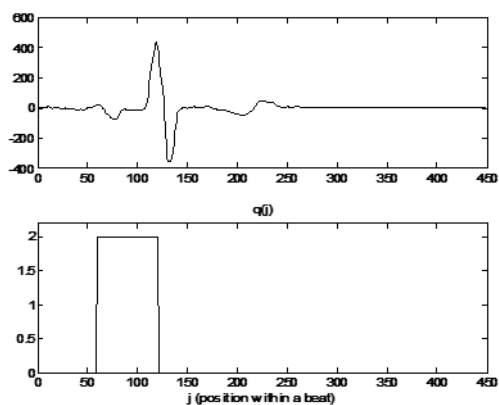

Fig. 6. The dimensions of local signal subspaces assuring extraction of high quality foetal ECG traces (see Fig. 5). The upper picture presents the average maternal ECG beat; the lower one the dimensions corresponding to the respective positions within the beat. The embedding dimension $m = 60$ was applied

For $q = 0$ we again obtained the foetal QRS complexes of the similar, high amplitude. On the other hand, some residua of the maternal complexes are very high as well. For $q = 2$ the residua vanished, but some attenuation of the foetal QRS complexes appeared. Fortunately, in projective filtering of time-aligned ECG beats [14] we can apply different dimensions of local signal subspaces. According to the above discussion, it is advantageous to set $q = 2$ for the subspaces of the embedding space vectors which overlap QRS complexes, and to set $q = 0$ in other parts of the beat. A plot of q as a function of the position within a beat, obtained according to these prescriptions, is presented in Fig. 6. The width of the nonzero part of the function is equal to the embedding dimension m . Thus, the first signal subspace with nonzero dimension corresponds to the embedding space vectors that overlap the left side of the QRS complex; the last one, to the vectors that overlap the right side of the complex. The application of such dimensions of local signal subspaces allowed to extract the FECG signal

presented in the lowest subplot of Fig. 5. In this signal the height of the foetal QRS complexes is similar to that obtained for $q = 0$, but the maternal ECG residua vanished.

5.2. Enhancement of the extracted foetal ECG. After successful suppression of the maternal ECG, we obtain the FECG signal which is corrupted by wide-band EMG and some low frequency contaminations. The application of projective filtering (block B5) allows for effective suppression of the EMG contaminations. Good results can be achieved for $m = 30$ and the dimensions of local signal subspaces depending on the position within a foetal beat (established similarly as in Fig. 6). After such an enhancement of the signal, the typical ECG waves are better visible (Fig. 7). To show that the developed method allows for a precise reconstruction of the foetal ECG, without distorting the desired signal morphology, we performed the following experiment. Two ECG signals from the MIT-BIH database were used to simulate the maternal and the foetal ECG respectively. To simulate the foetal component, the signal from the database was decimated (by rejecting every second sample, after the operation of low-pass filtering), and then added to the signal simulating the maternal ECG. The combined signal was artificially contaminated with white Gaussian noise. The resulting signal, the ECG used to simulate the foetal component, and the outputs of the MECG suppression and the FECG enhancement stages are presented in Fig. 8. Comparison of the simulated FECG with the reconstructed one shows that the proposed system allows for extraction of the foetal ECG without distorting its morphology.

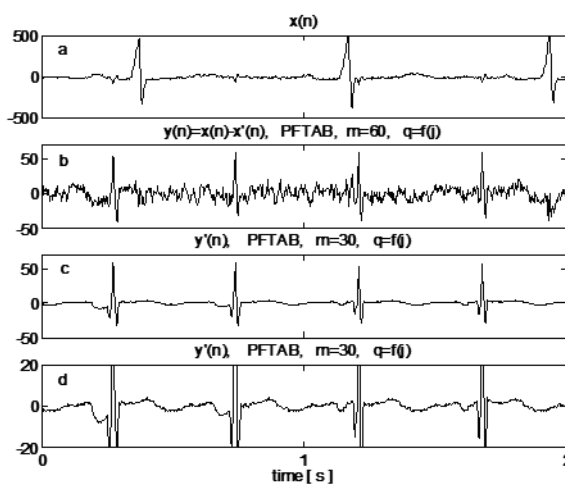

Fig. 7. The results of the most important stages of the system for foetal ECG extraction: a) a maternal abdominal ECG signal, b) the results of maternal ECG suppression, c) the results of foetal ECG enhancement by application of projective filtering (B5), d) the same as in c, but magnified to visualize the low amplitude parts of the foetal ECG (to obtain more typical PQRST morphology the signals in b, c and d were multiplied by -1)

The figures presented so far show an application of projective filtering to FECG extraction for the analysis of the signal morphology. When determination of the foetal heart rate is the only goal, higher cutoff frequency of the high-pass filter can

be applied (in [20] 10 Hz appeared advantageous) and the rest of the parameters can be left unaltered. The system operation in such conditions is presented in Fig. 9. It is less complicated since, after high-pass filtering, the low amplitude waves of the maternal ECG are much attenuated, and the main goal of the system is the suppression of the maternal QRS complexes. In Fig. 9 we can notice that, in spite of the comparable levels of the FECG and the MECG, the extracted foetal signal is of high quality, with complexes of the similar amplitude. Even the overlapping of the maternal and the foetal complexes did not spoil the results. Such properties of the obtained signals (a low level of noise and a similar amplitude of the respective foetal QRS complexes) are advantageous, particularly if the operation of foetal QRS complexes detection is of the primary interest.

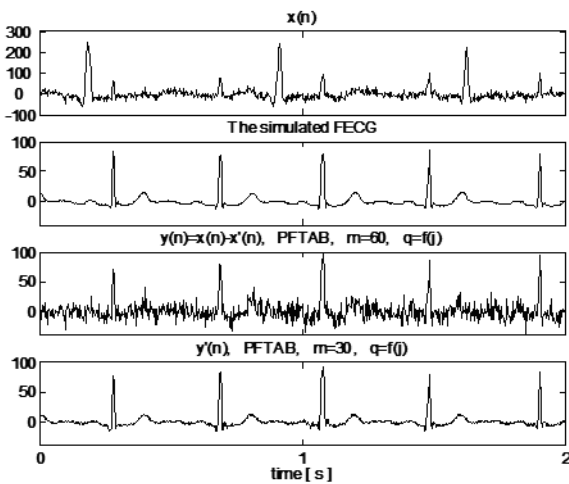

Fig. 8. The results of foetal ECG extraction obtained in a simulated case: the artificial abdominal ECG is presented in subplot a; the clean 'foetal' component in b; the results of MECG suppression in c; and the enhanced 'FECG' in d

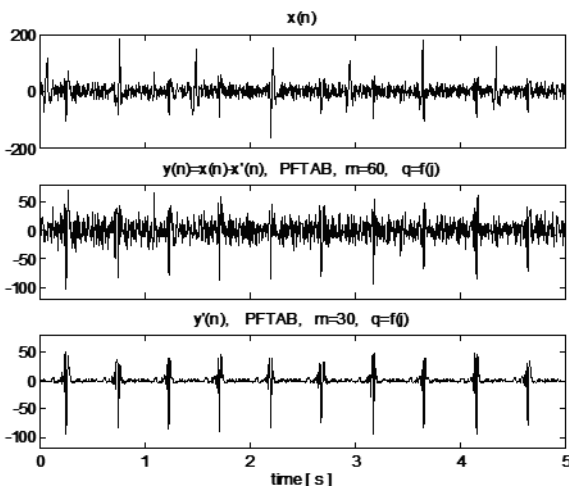

Fig. 9. The results of the foetal ECG extraction when high-pass filtering with a cutoff frequency of 10 Hz was applied: a) a maternal abdominal ECG signal, b) the results of maternal ECG suppression, c) the results of foetal ECG enhancement by application of projective filtering (B5)

5.3. A comparison to the NSSP method. The NSSP method can be applied to FECG extraction similarly as the PFTAB method: in the first stage of the operation – to enhance the maternal ECG. Then the enhanced MECG is subtracted from the composite signal and, this way, the FECG component is extracted. Quality of the extracted FECG depends on the results of the first operation of maternal ECG enhancement. There are, again, two requirements which should be fulfilled: the necessity of precise reconstruction of the MECG – so as the operation of subtraction allowed to cancel this component, and the necessity to achieve very effective suppression of the FECG – so as to avoid the signal attenuation by the operation of subtraction. For NSSP it is particularly difficult to suppress the foetal ECG in the regions of the maternal ECG baseline. In the lower part of Fig. 1, we can notice that these regions are dominated by the foetal QRS complexes, and many small loops corresponding to these complexes are close to each other near the origin of the state-space coordinates. Determining neighbourhoods for the points located in this part of the trajectory, we face the risk of including many points overlapped similarly with the foetal QRS complexes. Calculating the mass centers of such neighbourhoods would lead not to the foetal QRS complexes suppression but, contrary, to their enhancement.

To diminish the discussed effects, a high embedding dimension should be applied, e.g. $m = 200$ (corresponding to an interval of 0.5 s, as suggested in [12]). For such a high dimension, determination of neighbourhoods depends more on the points position within maternal beats (because maternal QRS complexes overlap most of the trajectory points). Still, however, for high level of the FECG the signal is likely to dominate the constructed subspaces. When such a situation happens, the operation of projection does not lead to FECG suppression. To diminish this effect, a low dimension of the constructed signal subspaces should be applied. When the penalty matrix \mathbf{R} is applied, good results are achievable for $q = 1$.

The next parameter that allows us to influence the operation of maternal ECG enhancement is the radius ε of a neighbourhood. When the initial value of the radius is low, it often has to be raised to include at least k_{\min} points to a neighbourhood. For higher values of ε , the neighbourhoods cardinality in low amplitude parts of the maternal ECG is often very high. This prevents the neighbourhoods from being dominated by the foetal QRS complexes (which are not so numerous) and, in consequence, it leads to better suppression of the foetal ECG. Unfortunately, for $q = 1$ this leads to less precise reconstruction of the maternal ECG. In the experiments reported, we set $k_{\min} = 50$ (as in [12]) and we tried different values of ε , balancing between the need to suppress the FECG and the need to reconstruct precisely the MECG. In Fig. 10 and Fig. 11 the results of MECG suppression achieved for the signals which were employed in the previous experiments are presented. The signal in Fig. 10 is of very low level of noise. In this case, application of NSSP with a low radius allowed to achieve precise reconstruction of the maternal ECG, but not very effective suppression of the FECG. In consequence, the

operation of subtraction caused effective suppression of the maternal complexes and, unfortunately, a significant attenuation of the foetal ECG. For $\varepsilon = 500$ the results are better; the foetal QRS complexes are higher and the MECG suppression is effective. For $\varepsilon = 800$ too many points were included into the neighbourhoods, which decreased the precision of MECG reconstruction. As a result, the extracted FECG contains high residua of the maternal signal. The results achieved by PFTAB were slightly better than the best results of the NSSP method.

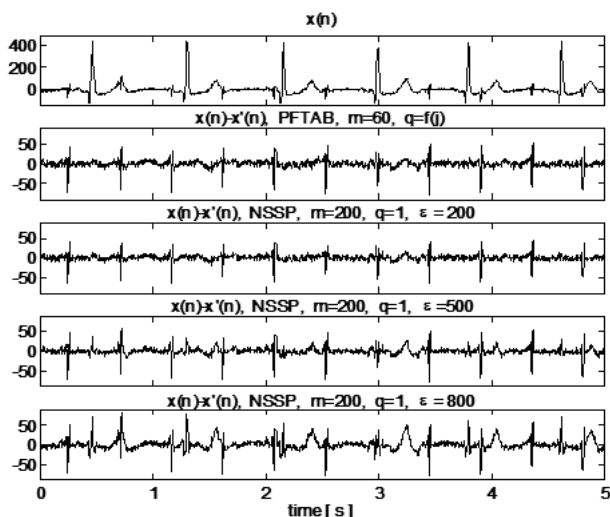

Fig. 10. The results of MECG suppression obtained by application of PFTAB or NSSP when the abdominal signal with low level of noise, and a moderate amplitude of the foetal ECG, was analyzed

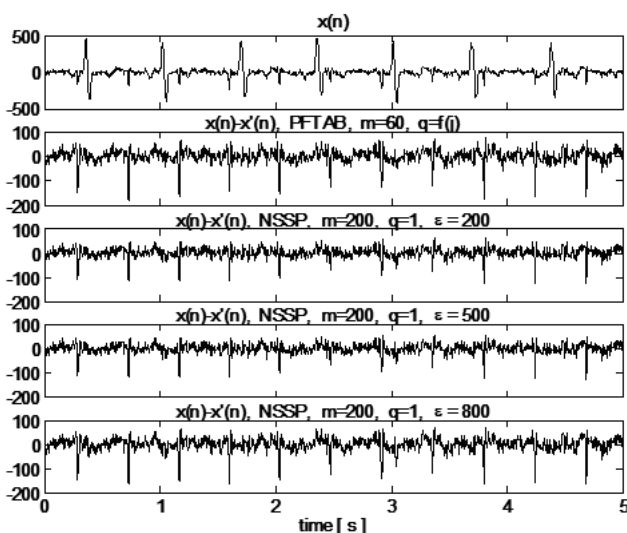

Fig. 11. The results of MECG suppression obtained by application of PFTAB or NSSP when the abdominal signal with moderate level of noise, and a relatively high amplitude of the foetal ECG, was analyzed

The signal presented in Fig. 11 contains a higher level of the electromyographic noise, and also the FECG of higher amplitude. For this signal, the results obtained for $\varepsilon = 200$ and for $\varepsilon = 500$ are rather poor. Only application of $\varepsilon = 800$

prevented the system from attenuating the extracted foetal ECG. For this level of EMG noise, the residua of the maternal ECG are acceptable. Again, the results achieved by PFTAB are comparable or slightly better than the best results of NSSP. Moreover, it should be stressed that the system based on PFTAB can be applied with the same parameters to different signals whereas the proper operation of the system based on NSSP requires a careful adjustment to the conditions encountered. Additionally, with the growth of the FECG amplitude it is more and more difficult to find the radius ε which would allow for MECG enhancement and FECG suppression by application of NSSP.

Comparing both methods we should take into account their computational costs. To check this aspect, both methods were applied in Matlab environment without speed optimization to the analysis of a signal segment of 80 s (as in [12,14]). The execution time depended highly on the applied parameters of the methods (the dimensions m and q). However, in all cases tested, PFTAB was more than a hundred times faster than the NSSP method.

6. Conclusions

Extraction of the foetal electrocardiogram from single-channel signals without disturbing its morphology is a difficult task. The method of projective filtering of time-aligned ECG beats appears to address this problem successfully. It allows for effective suppression of the maternal ECG without the necessity to apply prior high-pass filtering with a high cutoff frequency, as it is necessary when most methods of foetal ECG extraction from single-channel signals are considered. The application of different dimensions of local signal subspaces allows for very effective suppression of the maternal ECG with limited attenuation of the foetal QRS complexes. The developed system preserves the morphological content of the extracted signals not disturbed. Moreover, properties of the foetal signals extracted by the system application are very advantageous as far as the problem of foetal QRS complexes detection is considered. The system is more effective, and much faster than the system for foetal ECG extraction based on the original method of the nonlinear state-space projections.

REFERENCES

- [1] H.M.L. Jenkins, "Technical progress in fetal electrocardiography-a review", *J. Perinat. Med.* 14, 365–370 (1986).
- [2] B. Widrow, et.al., "Adaptive noise cancelling: principles and the applications", *Proc. IEEE* 63, 1692–1716 (1975).
- [3] P. Bergveld and J.H. Meijer, "A new technique for the suppression of the MECG", *IEEE Trans. Biomed. Eng.* 28, 348–354 (1981).
- [4] D. Callaerts, B. De Moor, J Vandewalle, and W. Sansen, "Comparison of SVD methods to extract the foetal electrocardiogram from cutaneous electrode signals", *Med. & Biol. Eng. & Comput.* 28, 217–224 (1990).
- [5] L. De Lathauwer, B. De Moor, and J. Vandewalle, "Fetal electrocardiogram extraction by source subspace separation", *Proc. IEEE SP/ATHOS Workshop on HOS*, 134–138 (1995).

Projective filtering of time-aligned beats for foetal ECG extraction

- [6] J.F. Cardoso and A. Souloumiac, "Blind beamforming for non-Gaussian signals", *Proc. Inst. Elect. Eng. F* 140 (6), 362–370 (1993).
- [7] J.-F. Cardoso, "Multidimensional independent component analysis", *Proc. ICASSP'98* 4, 1941–1944 (1998).
- [8] Zarcoso and A.K. Nandi, "Noninvasive fetal electrocardiogram extraction: blind separation versus adaptive noise cancellation", *IEEE Trans. Biomed. Eng.* 48, 12–18 (2001).
- [9] M. Kotas, "Independent versus principal component analysis for fetal ECG extraction", *Proc. Int. Conf. SYMBIOSIS*, 108–115 (2001).
- [10] J. H. Nagel, "Progress in fetal monitoring by improved data acquisition", *IEEE Trans. Biomed. Eng.* 31, 9–13 (1984).
- [11] P. P. Kanjilal, S. Palit and G. Saha, "Fetal ECG extraction from single channel maternal ECG using singular value decomposition", *IEEE Trans. Biomed.* 44, 51–59 (1997).
- [12] T. Schreiber and D. Kaplan, "Nonlinear noise reduction for electrocardiograms", *Chaos* 6, 87–92 (1996).
- [13] M. Richter, T. Schreiber, and D.T. Kaplan, "Fetal ECG extraction with nonlinear state space projections", *IEEE Trans. Biomed. Eng.* 45, 133–137 (1998).
- [14] M. Kotas, "Projective filtering of the time-aligned ECG beats", *IEEE Trans. Biomed. Eng.* 51, 1129–1139 (2004).
- [15] P. Grassberger, R. Hegger, H. Kantz, C. Schaffrath, and T. Schreiber, "On noise reduction methods for chaotic data", *Chaos* 3, 127–141 (1993).
- [16] I.T. Jolliffe, *Principal Component Analysis*, Springer Verlag, New York, 1986.
- [17] P.S. Hamilton and W.J. Tompkins, "Quantitative investigation of QRS detection rules using the MIT/BIH arrhythmia database", *IEEE Trans. Biomed. Eng.* 33, 1157–1165 (1986).
- [18] H.H. Chou, Y.J. Chen, Y.C. Shiau, and T.S. Kuo, "An effective and efficient compression algorithm for ECG signals with irregular periods", *IEEE Trans. Biomed. Eng.* 53, 1198–1205 (2006).
- [19] M. Kotas, "Fetal QRS Detection – Quantitative Investigation of a Class of Algorithms", *Biocybernetics and Biomedical Engineering* 16 (3–4), 133–145 (1996).
- [20] M. Kotas, "A new method of fetal QRS detection", *Biocybernetics and Biomedical Engineering* 16 (3–4), 147–163 (1996).
- [21] J.A. van Alsté, W. van Eck, and O.E. Herrmann, "ECG baseline wander reduction using linear phase filters", *Computers & Biomed. Research* 19, 417–427 (1986).
- [22] M. Kotas, "Projective filtering of time-aligned ECG beats for repolarization duration measurement", *Computer Methods and Programs in Biomedicine* 18, 115–123 (2007).