

# Comparative Analysis of the Efficiency of Detecting Some Amplitude-Phase Modulated Signals in Wireless Communication Systems

Andriy P. Bondariev, Ivan V. Horbatyi, Ivan P. Maksymiv, and Sergiy I. Altunin

**Abstract**—This article presents the results of the research of noise-immunity of wireless communication systems using signals that are formed on the basis of eight-position quadrature-amplitude modulation (8-QAM) and eight-position amplitude modulation of many components (8-AMMC). The research was conducted using simulation of a wireless communication system, built using a detector, implemented on the basis of a phase locked loop. The influence of phase locked loop parameters on the detection quality of these signals in the condition of the interference in the communication channel was researched, and a comparative analysis of the noise immunity of wireless communication systems using these signals was carried out.

**Keywords**—8-QAM, 8-AMMC, signal-to-noise ratio, noise immunity, phase detector, phase locked loop

## I. INTRODUCTION

MODERN wireless communication systems use signals with complex types of modulation to efficiently use the dedicated frequency range [1]. The variety of existing types of modulation is quite extensive. The selection of adequate modulation for the design of the communication system is based on certain criteria. These criteria depend on the type of communication system and the tasks that it must solve. In particular, for cellular communication systems, an important criterion is the minimum signal-to-noise ratio, in which subscribers of the network will receive service with proper quality [2, 3]. The relationship between the minimum signal-to-noise ratio and frequency efficiency is the determining criterion for evaluating the communication system, since it indicates the quality of service that can be provided to the end user within the selected frequency range.

The wireless communication systems using two types of signals are considered in this paper – with eight-position quadrature-amplitude modulation (8-QAM) and eight-position amplitude modulation of many components (8-AMMC), the efficiency of their detection in conditions of high level of interference in the communication channel is investigated using computer simulation and analyzed the simulation results.

In order to construct an adequate simulation model in this work, the influence of the parameters of phase locked loop devices (PLL) on the efficiency of detection of the above-mentioned signals was also researched, as these devices are an integral part of the receivers of modern wireless communication systems. Therefore, the choice of the correct parameters of the

PLL is a prerequisite for conducting a comparative analysis of the efficiency of the signal interpretation by the detector.

## II. FORMULATION OF THE PROBLEM

As noted earlier, the object of the research are wireless communication systems using two types of amplitude-phase modulation – 8-QAM and 8-AMMC. Before proceeding with the construction of their adequate mathematical models, a thorough research of the process of forming these signals was conducted.

Quadrature amplitude modulation 8-QAM is used in digital radio frequency signaling schemes. When it is used, two digital streams of bits are transmitted by changing the amplitudes of the two carrier signals, using amplitude manipulation as digital modulation schemes. The 8-QAM modulation is one of the possible variations of quadrature-amplitude modulation, which allows the transmission of eight possible symbols expressed by two values, one of which is the amplitude of the in-phase component, and the other is the amplitude of the quadrature component (Fig. 1).

The papers [4, 5] describe an alternative form of eight-position amplitude-phase modulation – amplitude modulation of many components (AMMC). Like 8-QAM, this modulation provides the ability to transmit eight symbols, but the location of these values in the constellation is different (Fig. 2). According to the author, in some cases, this configuration provides the better system immunity.

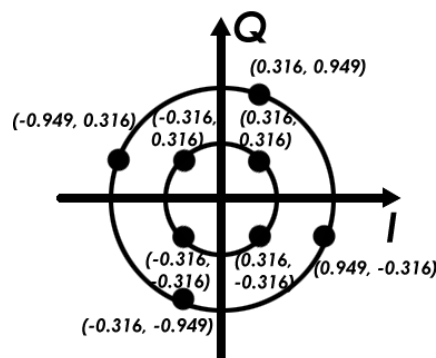

Fig. 1. 8-QAM signal constellation

This work was supported by Ministry of Education and Science of Ukraine under project No 0118U000261.

A. P. Bondariev (Lviv Polytechnic National University, bondap@ukr.net).

I. V. Horbatyi (Lviv Polytechnic National University, giv@polynet.lviv.ua).

I. P. Maksymiv (Lviv Polytechnic National University, ivan.p.maksymiv@lpnu.ua).

S. I. Altunin (Lviv Polytechnic National University, serg.alt.i@gmail.com).

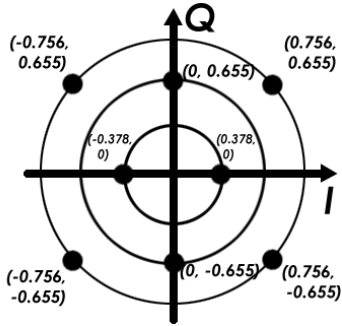

Fig. 2. 8-AMMC signal constellation

In the digital form, the amplitude of the in-phase and quadrature components of both 8-QAM and 8-AMMC signals can be interpreted using sequences of three bits, so simulation of such signals should be implemented with the help of software. As such software was used Matlab software [6], because its functionality is sufficient to simulate the above-described signals.

In order to construct an adequate model of the communication channel, the implementation of the process of synchronous detection of signals with complex phase modulation was also researched. In particular, the scheme of digital PLL proposed by R. Best [7] was considered. This scheme has become widely implemented, due to the simplicity and accessibility of its physical implementation (Fig. 3).

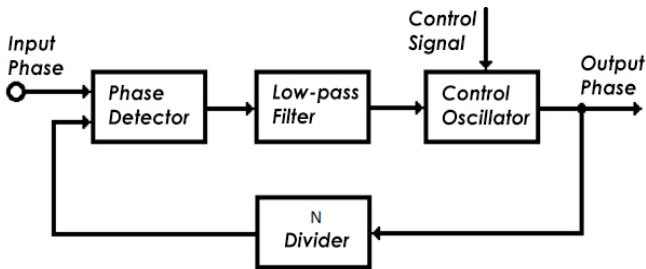

Fig. 3. Block diagram of a typical PLL loop filter

One of the main elements of this scheme is the PLL loop filter, parameters of which directly affect the detection efficiency of the signals and the noise immunity of the communication system in general. Therefore, the realized simulation model of such a detector should provide the ability to change the parameters of the loop filter.

By combining the software implementations of the investigated signals of the 8-QAM and 8-AMMC with the simulation model of the communication channel, their further comparative analysis was carried out.

### III. CONSTRUCTION OF SIMULATION MODEL OF COMPLEX QUADRATURE SIGNALS

The Matlab software environment was used for simulation of 8-QAM signal. The value of the angle and amplitude of the signal was formed using an information digital signal, which is a sequence of bits, formed by the program as an array. This sequence was divided into three-bit fragments. Using bit combinations from Table I, the phase and amplitude of the real and imaginary component of the modulated signal was formed.

The obtained values were imported into a two-dimensional array together with values of time intervals that set the sampling frequency of the signal. An eight-position information signal (Fig. 4 a) was formed at the output. Such a signal is ready for transmission to the communication channel. Its phase portrait (Fig. 4 b) corresponds to a real signal, which confirms the adequacy of the simulation model.

The simulation of the 8-AMMC signal was carried out in a similar way. Based on Table II, the phase and amplitude of the modulated signal were formed.

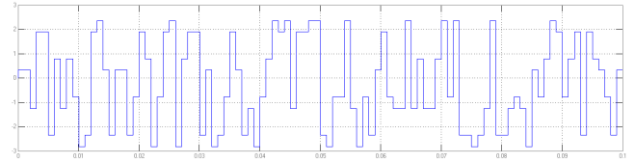

a)

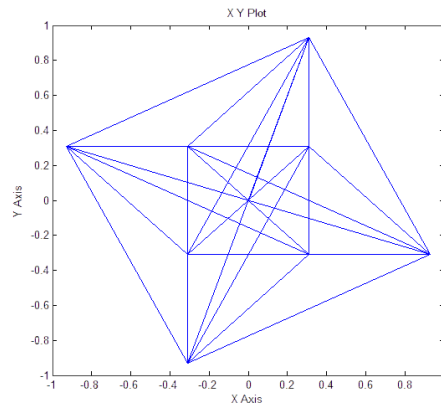

b)

Fig. 4. Informational 8-QAM signal

- a) time diagram
- b) phase portrait

TABLE I  
RULES OF THE FORMATION OF 8-QAM SIGNAL

Bit combination	Signal components value
1, 1, 1	$A = 0.447, \varphi = 45^\circ$
1, 1, 0	$A = 1, \varphi = 72^\circ$
0, 1, 0	$A = 0.447, \varphi = 135^\circ$
0, 1, 1	$A = 1, \varphi = 162^\circ$
0, 0, 1	$A = 0.447, \varphi = 225^\circ$
1, 0, 0	$A = 1, \varphi = 252^\circ$
0, 0, 0	$A = 0.447, \varphi = 315^\circ$
1, 0, 1	$A = 1, \varphi = 342^\circ$

TABLE II  
RULES OF THE FORMATION OF 8-AMMC SIGNAL

Bit combination	Signal components value
1, 1, 1	$A = 1, \varphi = 41^\circ$
1, 1, 0	$A = 0.655, \varphi = 90^\circ$
0, 1, 0	$A = 1, \varphi = 139^\circ$
0, 1, 1	$A = 0.378, \varphi = 180^\circ$
0, 0, 1	$A = 1, \varphi = 221^\circ$
1, 0, 0	$A = 0.655, \varphi = 270^\circ$
0, 0, 0	$A = 1, \varphi = 319^\circ$
1, 0, 1	$A = 0.378, \varphi = 0^\circ$

The obtained values were imported into a two-dimensional array together with values of time intervals that set the sampling frequency of the signal. An eight-position information signal (Fig. 5 a) was formed at the output. Its phase portrait (Fig. 5 b) corresponds to a real signal, which confirms the adequacy of the simulation model.

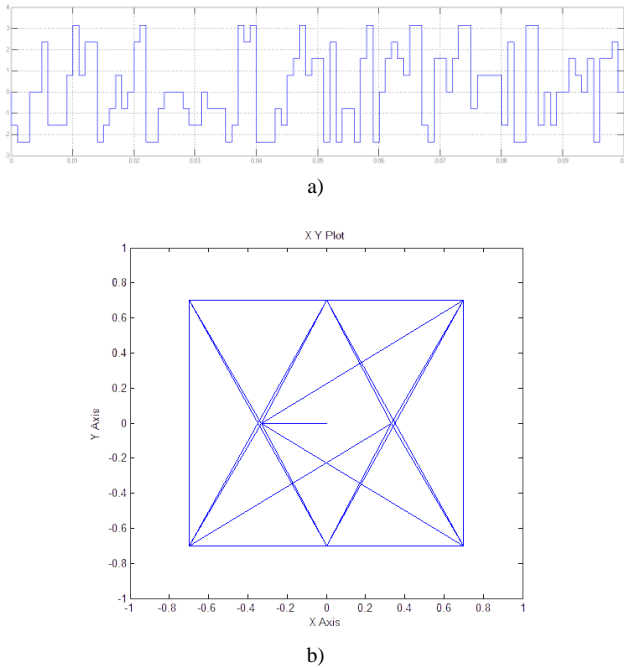

Fig. 5. Informational 8-AMMC signal  
 a) time diagram  
 b) phase portrait

The generated signals were sent to the communication radio channel for further research of the possibilities of their detection using the PLL.

#### IV. SIMULATION

In wireless communication systems with spectral-efficient types of modulation the main source of interference is the interference between neighboring subscribers. Additional factors that can cause interference are the multipath signal propagation in the air, the Doppler effect caused by the mobility of the subscribers, and the thermal noise in the communication equipment. All of these factors generate noise that can be characterized by a certain power and distribution law. In order to simulate this noise in the investigated model, a source of random signals of a certain power was implemented. These signals were added to the information signal and thus imitated the noise that arises during the propagation of the signal over the airspace. The noise power can be changed, so it has made it possible to investigate the efficiency of receiving signals at different noise levels in the communication channel.

The creation and verification of the adequacy of the simulation model of the wireless communication system using the phase detector and the PLL by means of the Matlab software has been described in detail in [8, 9]. To conduct research in this article, a similar simulation model was constructed, but without the use of a modified detector.

TABLE III  
 THE VALUE OF THRESHOLD NOISE POWER  $P_N(W)$  FOR SPECIFIC LOOP FILTER PARAMETERS WITH 8-QAM SIGNALS TRANSMISSION

$T_f(s) / m$	0.1	0.3	0.5	0.7
0.1	13.3 (8.76 dB)	13.2 (8.79 dB)	12.5 (9.03 dB)	12.9 (8.89 dB)
0.3	12.3 (9.1 dB)	12.6 (9 dB)	12.5 (9.03 dB)	12.6 (9 dB)
0.5	12.4 (9.07 dB)	12.4 (9.07 dB)	12.4 (9.07 dB)	12.4 (9.07 dB)
0.7	12.5 (9.03 dB)	12.3 (9.1 dB)	12.3 (9.1 dB)	12.3 (9.1 dB)

The obtained simulation model consists of the following components (Fig 6):

- the source of the modulated signal;
- the communication channel in which it is possible to change the value of the noise power influence on the signal when it passes through the channel;
- detector, built on the basis of the PLL device.

The study of the 8-QAM modulation signal was carried out according to the following method: changing the value of the power of the additive noise in the communication channel at the given parameters of the PLL loop filter, the noise power value was found at which the threshold effect in the communication channel occurs (Fig. 7 b). Areas on time diagram, where the threshold effect occurs, are highlighted by a frame. In some places it is impossible to determine the phase value due to abnormal phase jumps, while in other places the phase of the signal acquires the opposite value. Repeated simulations were carried out for other filter parameters and thus the corresponding noise values were obtained, which resulted in a threshold effect.

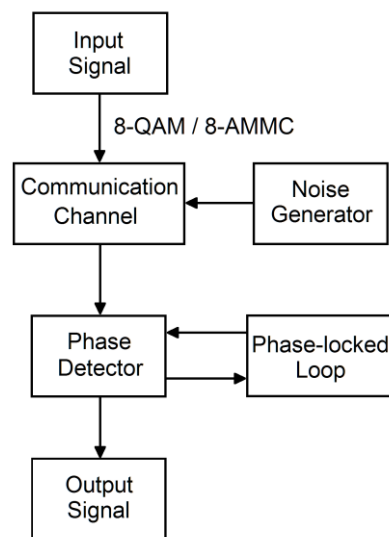

Fig. 6. Block diagram of the experimental simulation model

A time diagram of a signal with 8-QAM modulation at the output of the detector without the effect of interference in the communication channel shows in Fig. 7 a and the time diagram of the same signal after passing through the communication channel with a powerful additive interference shown in Fig. 7 b. At 0.05 second of the diagram, a breakdown of the signal phase occurs and the threshold effect appears.

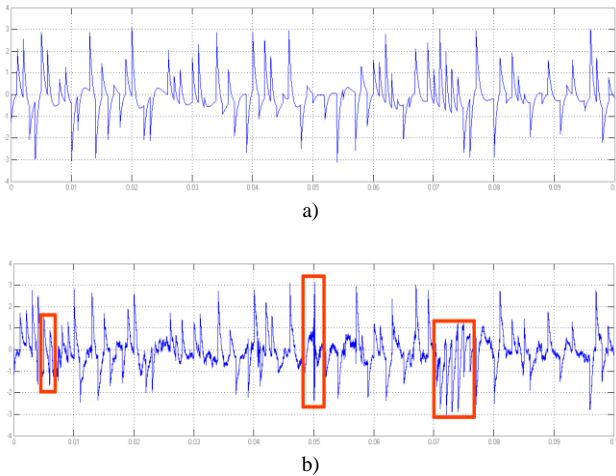

Fig. 7. Signal with 8-QAM modulation at the output of the detector without noise (a) and with noise power, which leads to the threshold effect (b)

By varying the number of changes in the loop filter parameters, namely, the time constant  $T_f$  and the proportionality coefficient  $m$ , the threshold power of the noise was determined, which gives the threshold effect for the specific filter parameters. The parameters of the filters and the corresponding noise values are given in the III.

From Table III it can be concluded that in the case of 8-QAM modulation, the most resistant to the interference is the configuration of the filter with the parameters  $T_f = 0.1$  s and  $m = 0.1$ .

The 8-AMMC modulation signal analysis was conducted in a similar way: changing the value of the power of the additive noise in the communication channel for the given parameters of the PLL loop filter, the noise power value was found at which the threshold effect in the communication channel occurs (Fig. 8 b). Areas on time diagram, where the threshold effect occurs, are highlighted by a frame. In some places, it is impossible to determine the phase value due to abnormal jumps, while in other places the phase of the signal acquires the opposite value. Repeated simulations were carried out for other filter parameters and thus the corresponding noise values were obtained, which resulted in a threshold effect.

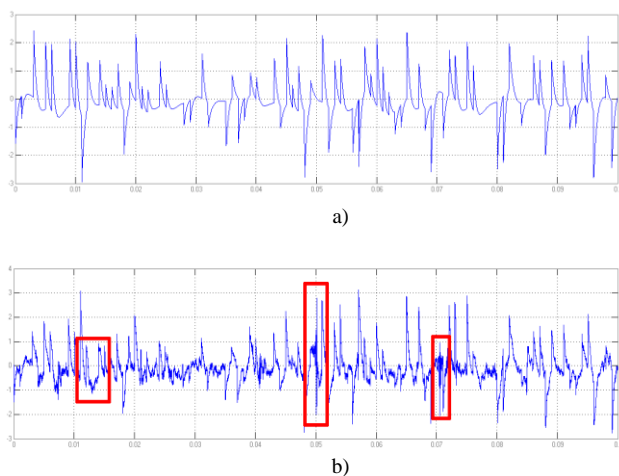

Fig. 8. Signal with 8-AMMC modulation at the output of the detector without noise (a) and with noise power, which results in a threshold effect (b)

A timing diagram of a signal from 8-AMMC modulation at the output of the detector without any interference in the communication channel shown in Fig. 8 a and the time diagram of the same signal after passing through the communication channel with a powerful additive interference shown in Fig. 8 b. At 0.01, 0.05 and 0.07 seconds of the diagram it is visible a breakdown of the monitoring of the phase of the signal, that is, the appearance of the threshold effect.

By varying the number of changes in the loop filter parameters, namely, the constant time  $T_f$  and the proportionality coefficient  $m$ , the threshold power of the noise was determined, which gives the threshold effect for the specific filter parameters. The parameters of the filters and the corresponding noise values are given in the Table IV.

TABLE IV  
THE VALUE OF THRESHOLD NOISE POWER  $P_N(W)$  FOR SPECIFIC LOOP FILTER PARAMETERS WITH 8-AMMC SIGNALS TRANSMISSION

$m \backslash T_f(s)$	0.1	0.3	0.5	0.7
0.1	12.1 (9.17 dB)	12.4 (9.07 dB)	12.6 (9 dB)	12.6 (9 dB)
0.3	12.1 (9.17 dB)	12.2 (9.14 dB)	12.3 (9.1 dB)	12.5 (9 dB)
0.5	12.3 (9.1 dB)	12.3 (9.1 dB)	12.1 (9.17 dB)	12.1 (9.17 dB)
0.7	12.3 (9.1 dB)	12.2 (9.14 dB)	12.2 (9.14 dB)	12.1 (9.17 dB)

From Table IV, it can be concluded that in the case of 8-AMMC modulation, there are several filter configurations that are most resistant to the noise, in particular with the parameters:

- 1)  $T_f = 0.5$  s and  $m = 0.1$ ;
- 2)  $T_f = 0.7$  s and  $m = 0.1$ .

The obtained simulation results provided the opportunity to select the most optimal loop filter parameters that were used in the further research of the noise immunity of wireless communication systems with 8-QAM and 8-AMMC signals.

In order to adequately assess the noise immunity of the selected modulation types, a research was made using long sequences of modulated signals at different noise levels in the communication channel, based on which a statistical analysis was performed.

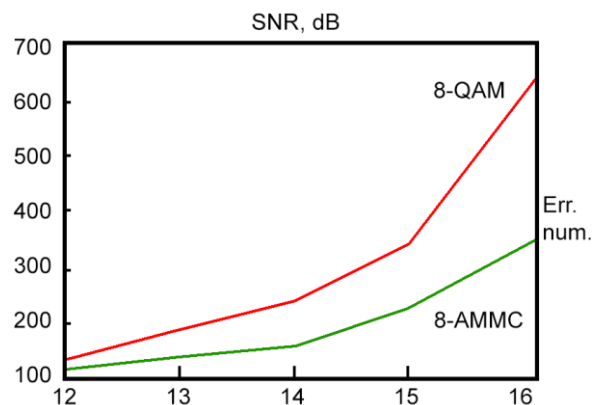

Fig. 9. Comparison of 8-QAM and 8-AMMC signals at different SNR

During statistical analysis, an estimate of the amount of bit errors on the output of phase detector was received. Simulation for both types of signals took place using three signal-to-noise ratios in the communication channel:

- 1) SNR = 12 dB;
- 2) SNR = 14 dB;
- 3) SNR = 16 dB.

The simulation results are shown in Table V and on Fig. 9.

TABLE V  
COMPARE NOISE IMMUNITY OF 8-QAM AND 8-AMMC SIGNALS

SNR, dB	Errors number using 8-QAM signals	Errors number using 8-AMMC signals
12	139	112
14	240	140
16	631	328

As seen from Table V, when the noise level in the communication channel is 12 dB, the number of errors encountered when detecting signals with 8-QAM and 8-AMMC modulations does not differ substantially, however, with the increase of the signal-to-noise ratio, the noise immunity of wireless communication system with using 8-AMMC signal is rapidly increasing and it reaches almost 100% for signal-to-noise ratio of 16 dB.

## V. CONCLUSIONS

The research of the process of 8-QAM and 8-AMMC signals detection with a phase detector designed on the basis of a phase locked loop, under the condition of the high-power interference in the wireless communication channel, was carried out. By changing the parameters of the PLL loop filter, optimum filter parameters were found, at which detection is most effective in

the case of low signal-to-noise ratio in the communication channel. Using the recommended parameters, a further comparative analysis of the wireless communication systems using two types of signal modulation – 8-QAM and 8-AMMC was performed. The analysis showed that wireless communication system with using 8-AMMC are more resistant to noise, especially with increasing noise in the wireless communication channel.

The obtained parameters can be applied as the reference during the design of real signal detectors with complex phase and amplitude-phase modulation.

## REFERENCES

- [1] Bajrang Bansal, Sanjay Soni, Nitin Jain. "Time-domain analysis of monocycle pulse propagation for 5G UWB communications", ICCCA, Greater Noida, 2017.
- [2] G.P. Efthymoglou, P.S. Bithas, A.G. Kanatas. "Exact SNR and SIR analysis in Poisson wireless networks", Electronics Letters, vol. 53, p. 356-358, 2017.
- [3] A.G. Razvan, V. Iordache, I. Badescu. "Analysis of possible Wi-Fi interferences of wireless communications implemented in vehicular environments", TELSIS, Nis, 2017.
- [4] I.V. Gorbatyy. "Optimization of signal-code constructions using the maximum efficiency criterion", Radioelectronics and communications systems, 2013, Vol. 56, Issue 12, P. 560-567. DOI: 10.3103/S0735272713120029
- [5] I.V. Gorbatyy. "Investigation of the technical efficiency of state-of-the-art telecommunication systems and networks with limited bandwidth and signal power", Automatic Control and Computer Sciences, 2014, Vol. 48, Issue 1, P. 47-55. DOI: 10.3103/S0146411614010039.
- [6] Mathuranathan Viswanathan. "Digital Modulations using MATLAB. Building Simulation Models from Scratch", Pilani, 2017.
- [7] BestRoland E. "Phase-Locked Loops: Design, Simulation, and Applications, Sixth Edition", McGraw-Hill Education, New York, 2007.
- [8] Bondariev A.P., Maksymiv I.P. "Ways of significant increase of noise immunity in systems of a cellular communication systems", Bulletin "Radioelectronics and Telecommunications" - Lviv, 2012 – P.173-177
- [9] Bondariev A.P., Maksymiv I.P. "Method of improvement of quality indexes of detecting in cellular communication systems", "Electronics and electrical engineering", Kaunas, 2012. – No.10 – P.85-88.