

Design and Testing of an Electronic Control System Based on STM X-Nucleo Board for Detection and Wireless Transmission of Sensors Data Applied to a Single-Seat Formula SAE Car

P. Visconti, B. Sbarro, P. Primiceri, R. de Fazio, and A. Lay-Ekuakille

Abstract—The emerging potentials in the electronics field, which facilitate the creation of complex projects with innovative functionalities, while maintaining low costs, are becoming even more appreciated by designers and engineers. In this manuscript, a telemetry system was designed and realized for monitoring main parameters of a racing vehicle. A STM32 Nucleo board acquires data from sensors installed on vehicle and transmits them to a base station. Acquired data are both stored on a SD card and wirelessly transmitted, for ensuring robustness/reliability of operation. The carried out tests confirm the truthfulness and compatibility of acquired data related to the vehicle parameters.

Keywords—telemetry, sensors, wireless monitoring, data communication, firmware, electronic modules.

I. INTRODUCTION

IN the last years, the electronics world has undergone great changes becoming even more “open source” and giving the possibility to the users, designers and engineers to create, in a few time, complex projects with innovative functionalities and high performances, while maintaining low costs. The electronic systems equipping the vehicle are enabling to solve numerous issues related the automotive field, mainly in the competition/races field. Relative to this field, the integration of electronic devices for monitoring the main parameters, that feature the moving vehicle, are assuming an increasingly important role first of all for safety of pilot life and, in second instance, for enhancing the performances of the vehicle. The “Formula SAE”, Society of Automotive Engineers (SAE), represents a competition in which the participating academic teams compete in the design, construction and testing of prototype single-seater cars [1].

The mechanical system of the SRT16 single-seater prototype realized by Salento University team is composed essentially of the engine unit, which gives the drive torque to the rear wheels, of the steering system to transmit to front wheels the direction of the motion set by pilot and finally, of suspensions system, to decouple the road surface by the vertical motion of car bodywork. The realized electronic system is able to collect data related to mechanical system and to vehicle dynamics and to send them, wirelessly, to a base station to be constantly monitored by technicians [2,3].

Several research works focused on systems for monitoring and control in real time of the principal parameters featuring the vehicles movement and driving conditions, conditioned by many factors (e.g. road wetness, resistance, terrain, traffic and even weather) that greatly influences vehicle performance. A driving condition control system for a hybrid electric vehicle (HEV) was presented in [4], through an intelligent multi-features statistical approach. A telemetry system was developed in [5] for monitoring of agricultural electrical vehicles, used for different purposes like farms, nurseries, greenhouses and vineyards. The monitoring of agricultural vehicles is important for safe operation and to measure in real time, besides vehicle speed, electrical parameters (i.e. voltage, current, battery capacity) [5]. Data acquisition and telemetry systems, for industry and aerospace applications, were designed in [6]; the authors proposed a real time DAQ system, with reduced size and weight, capable of connecting with different pressure and temperature sensors by means of 32 low frequency and two high frequency channels. A telemetry system for monitoring the performances of a solar-powered vehicle was developed in [7]; data collected onboard, over an ISO 11898/CAN bus, were sent to a Wi-Fi access point for remote control. Telemetry systems are applied in different fields ranging from automotive, aerospace to health monitoring. For example, an electro-cardiogram (ECG) telemetry system for continuous cardiac health monitoring applications was proposed in [8]; the authors developed a light-weight ECG SQA method for automatically assessing the quality of acquired ECG signals under different conditions and environments. The authors in [9] designed an efficient tool for monitoring acoustic signals in adverse environments, namely in geophysical explorations, in oil/gas mining industry and military applications. The Distributed Acoustic Sensing (DAS) systems have shown that the sensors based on this technology are excellent for implementing reliable telemetry systems in the hostile environments. Many other research works deal with telemetry systems for automotive and other application fields [10].

Furthermore, in the last decade several telemetry systems for automotive applications were proposed on the market; for instance, the British company *VBOX Automotive* has launched on the market a wide range of data logger for monitoring, analyzing and recording the main vehicle's parameters, as speed, distance, acceleration, braking distance, heading, slip angle, roll, lap times, position, cornering force and more. This is obtained by means of high performance GPS receivers and

by a proper elaboration of position information for extracting the useful data; specifically, the data logger *VBOX 3i* uses a powerful GPS/GLONASS receiver able to log data with high level of accuracy up to 100 times to second. It can ensure an improved accuracy and responsivity on all measured parameters, by means of the integration of both a proprietary IMU (inertial measurement unit) and a Kalman filter (Fig. 1a). The velocity and heading data are extracted from the Doppler shift in the GPS carrier signal, enabling to the users a very high accuracy, whereas, the brake distance is extracted from the trigger signal provided by the brake pedal, ensuring an accuracy on braking distance of $\pm 1.8\text{cm}$ (for further info see <https://www.vboxautomotive.co.uk/index.php/en/products/data-loggers/vbox-3i>).

Another company very active in the design and realization of telemetry systems for automotive application is the *KMT (Kraus Messtechnik) systems*. The developed systems are designed for mobile data acquisition, transmitting, storing and analysis of strain, torque, vibrations, force, shock, displacement, temperature and flow under extreme rough conditions. The company proposes the *TI-PCM-IND* single-channel telemetry system, which represents an easy solution for the acquisition and wireless transmission of strain gage signal directly from a rotating shaft; specifically, it is able to acquire signals from strain gauges ($\geq 350\Omega$) both in full- and half- bridge configuration. The encoder is very compact ($32 \times 24 \times 14 \text{ mm}$) and light (16g), therefore, it can be easily applied to numerous usage scenarios. In fact, the transmitter can be placed directly on the rotating shaft, by means a fiber reinforced tape (Fig. 1c). The data transfer towards the receiver is carried out using the inductive transmission by PCM (pulse code modulation) signal applied to an inductive winding directly rolled up on the shaft. The maximum distance between the transmitter coil and the pickup/powerhead is 30mm (for further information see <https://www.kmt-telemetry.com/telemetry/1-channel-telemetry/t1-pcm-ind/>).

A further company developing advance telemetry systems for automotive tests and characterizations is the *Datatel telemetry*; this last proposes a wide range of solutions for the monitoring of rotating and reciprocating system, common in the automotive, railroad and process industry as well as in turbo-machinery and aerospace installation (for further information see <https://www.datatel-telemetry.de/de/>). In automotive testing applications, the standard requirement is the measurement of torque and force on drivetrain components, as half-shafts, camshafts, cardan shafts or on the steering system, but also temperature on turbocharger, clutch and brake disk (Fig. 1b). In addition, *Datatel telemetry* develops and designs miniaturized wireless transmitters, which equip all their standard sensors; hence, the data from each sensor are wirelessly sent to the receiving unit at a selected radio frequency (in the MHz range). The receiving unit collects the data from the different distributed sensors and transfers them to a data acquisition system for their elaboration. The telemetry transmitters have a dual power supply, either by a battery or by inductive power transfer.

The present manuscript describes an effective and low cost telemetry system for acquiring the main physical and mechanical parameters of a moving vehicle. This system is constituted by a conditioning section for adapting the signals levels provided by sensors to input range of the STM-32

Nucleo F411RE prototyping board [11,12]. It constitutes the main section of the telemetry system, because processes the data acquired from the sensors and wirelessly transmits them, through the DORJI DRF1278F WiFi radio module, towards the base station. A Sparkfun CAN-BUS interfacing board enables the data exchange between the engine control unit and STM board to acquire the data from the sensors installed in the engine compartment. The main board, programmed with a proper developed firmware, acquires the data provided from the sensors, also by means of the CAN board, and wirelessly transmits the car data using a Wifi connection. Experimental tests confirms the correct data reception to base station, which show an optimum accordance between themselves, so demonstrating the correct operation of both acquisition section and communication section.

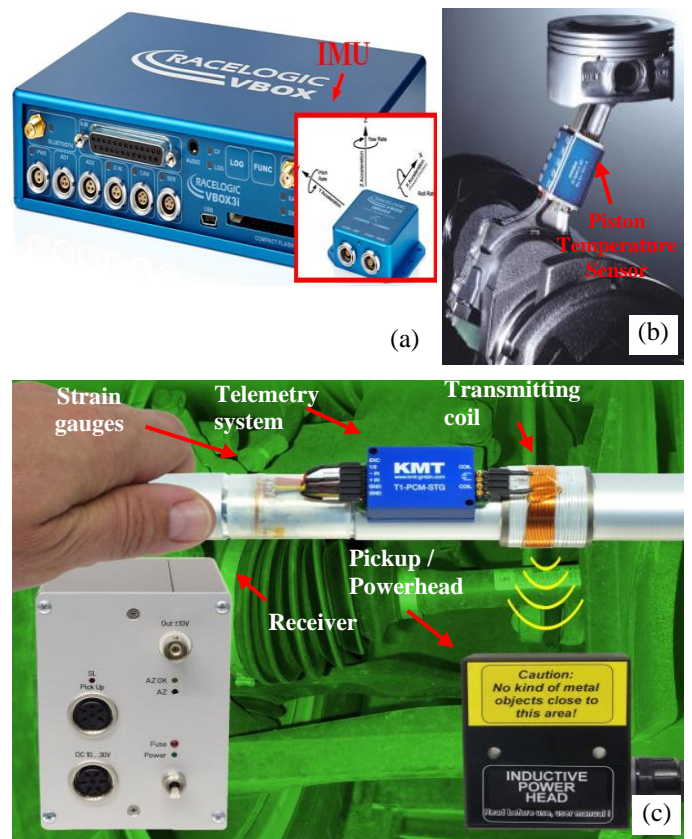

Fig. 1. Data logger *VBOX 3i* produced by *VBOX Automotive* equipped with the IMU (*RLVBIMU04-V2*) (a); piston temperature measurement system produced by *KMT systems* (b), *TI-PCM-IND* single-channel telemetry system applied on a rotating shaft.

II. METHODS AND MATERIALS

A. Realized telemetry system and operation mode

The main section of the proposed telemetry system is the data acquisition/transmission board. It allows a continuous monitoring of the car's mechanical system, namely of the suspensions, engine and cooling liquid temperatures and of the vehicle speed, thanks to the different employed sensors mounted on the vehicle, as shown in the car view of Fig. 2.

The connection between different sensors and the STM Nucleo board is realized directly, passing through the conditioning board, or by means of the engine control unit. In particular, sensors directly connected are the four linear

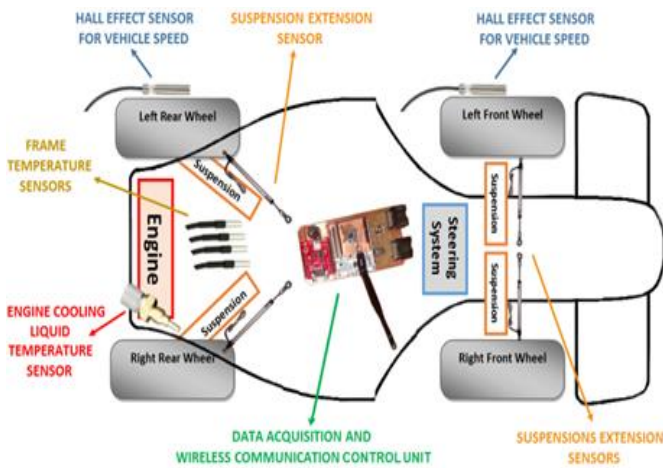

Fig. 2. Schematic view of the vehicle with indication of the different used sensors and their location on the mechanical structure of the vehicle.

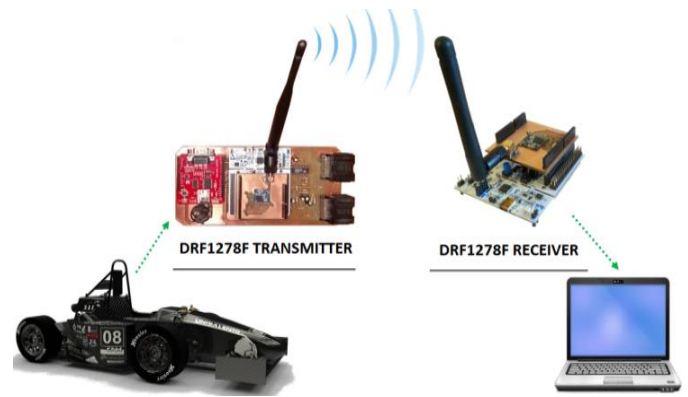

Fig. 4. Base station on the right with DRF1278F radio module in reception mode connected with PC through a ST Nucleo board and realized telemetry system on the left inside the car for data sensors detection and transmission.

potentiometers and four temperature transducers, whereas the sensors connected through the engine control unit are one NTC thermistor and two Hall effect sensors.

Collected data are stored on a SD memory card and sent wirelessly through the WiFi transceiver module, assembled on the top of the realized telemetry system. Such electronic board is constituted by four different modules (Fig. 3a and 3b): the conditioning section, the Nucleo-F411RE board, the Sparkfun CAN-BUS interfacing board and the DORJI DR1278F communication module. The conditioning board uses of two distinct connectors for connecting the different sensors, two sockets for the housing of Nucleo board and CAN-BUS module and finally, of the different electronic components needed for the conditioning and multiplexing of the signals provided from sensors. In the next paragraph, all electronic modules and employed sensors are described in detail.

As shown in Fig. 4, two WiFi DRF1278F radio modules are used: one installed on the vehicle and interfaced with the STM Nucleo board for data transmission and the other one, connected to a further STM Nucleo board, that communicates with a PC through UART interface, to display the data received from the base station.

B. Features of used devices and related functioning

This paragraph concerns the technical features, operating mode and circuitual schemes of used sensors and electronic modules/boards, as well as connection between them.

The first and most important module, the system brain, is the STM Nucleo-F411RE development board; it is based on the STM32 microcontroller and allows to acquire signals from sensors, to exchange data with all the employed modules and to synchronize all the operations; it is provided of connectors in order to connect very easily sensors and external hardware. The STM Nucleo board can be fed either by a USB connection or by an external power source, with voltage level between 3.3V to 12V. In this work, an external power supply of 9V, applied to VIN pin, was used.

The Sparkfun CAN-BUS module carries out two fundamental tasks: the interfacing between the STM Nucleo development board and engine control unit, for acquiring the data provided from NTC thermistor and Hall sensors and also the storing of collected data from all sensors on the SD memory card. Furthermore, through the CAN interfacing board, the vehicle tracking is possible through a GPS receiver (functionality not used). The employment of CAN module as serial standard interface for data exchange, derives from its strong immunity to the electromagnetic noise, peculiarity very important in automotive environment [13]. In the developed system, twisted-pair cables were used in order to further strengthen this feature. The Sparkfun CAN-BUS board includes both MCP2551 and MCP2515 ICs, that enable the interfacing with the prototyping board by means of SPI interface; specifically, the MCP2515 IC delivers the SPI interface, instead, the MCP2551 IC interfaces the MCP2551 IC with the communication bus for data exchange [14]. MCP2551 IC receives data from the MCP2515 and sends them to the physical channel through CANH and CANL connections; on the contrary, it receives data from physical channel and sends them to MCP2515 IC as shown in Fig. 5.

Four LM35 temperature sensors are placed on different section of the engine for monitoring their temperature and avoiding possible overheating. The interest temperature range is from 15°C to 120°C and minimum required resolution is 1°C; the LM35 temperature sensor allows to satisfy the

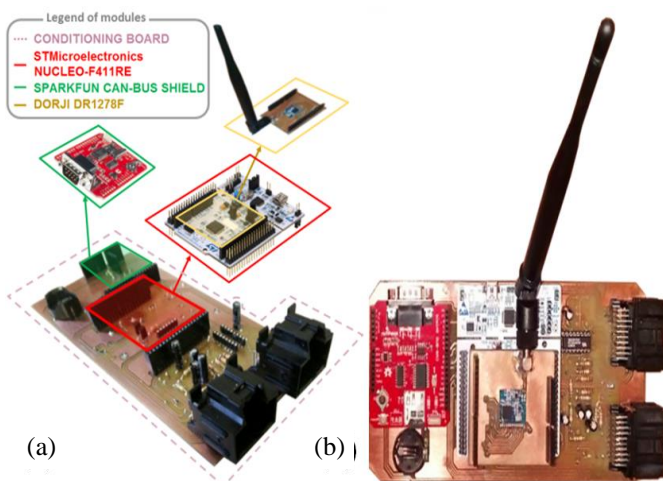

Fig. 3. Photo of the realized electronic control system for data acquisition and transmission via WiFi connection; view of the different modules disassembled and of their interconnections (a) and view of the complete data acquisition/transmission system with all modules assembled (b).

forementioned requirements due to its specifications. Specifically, it shows a highly linear response with the temperature, featured by a sensitivity of $10\text{mV}/^\circ\text{C}$ and typical accuracies of $\pm 1/4^\circ\text{C}$ at room temperature and $\pm 3/4^\circ\text{C}$ over full range $[-55 \div 150]^\circ\text{C}$. In Fig. 6, the connections of the four LM35 sensors with the Nucleo board are shown; a HCF4051 multiplexer (STMicroelectronics) was employed for selecting, after the device addressing, the desired sensor's output to be acquired. For each LM35 sensor, a $1\mu\text{F}$ capacitor, connected between the sensor output and ground, was added to filter some noise.

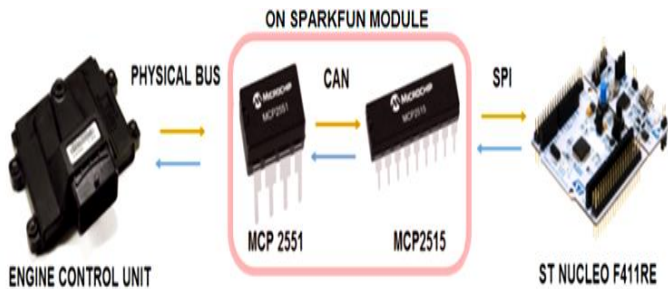

Fig. 5. Communication between the ST Nucleo F411RE board and engine control unit through the SPARKFUN electronic board.

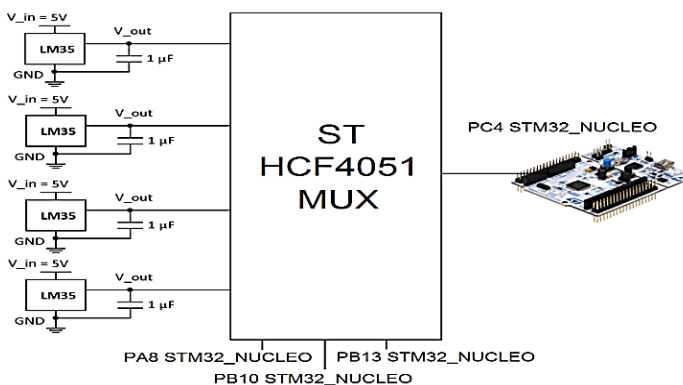

Fig. 6. View of the connections, by means of the ST HCF4051 multiplexer, between all the used temperature sensors and the ST Nucleo board.

A IXTHUS PZ-12-A-75P linear potentiometer (Fig. 7a) was selected for monitoring the compression / extension of suspensions; it is featured by an optimum mechanical reliability, key factor in environments with adverse conditions, and by IP65 code, a certification of resistance to dust and water, being located close to the suspensions [15].

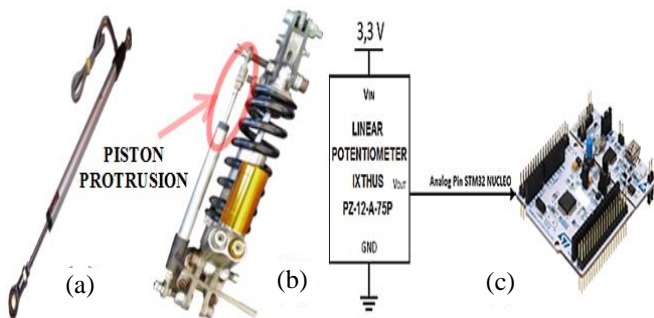

Fig. 7. IXTHUS potentiometer for measuring the suspension extension (a), sensor mounted on suspension (b) and connection with the STM board (c).

In the developed system, the linear transducers are polarized to 3.3V and their output voltage is acquired by the analog input of the STM Nucleo board (as shown in Fig. 7c); such transducer provides 3.3V of output voltage, when it reaches the maximum extension (75mm), instead, it provides 0V, when the minimum extension is reached (0mm). In rest conditions, the potentiometer shows a portion (37 mm) of the piston in protrusion (Fig. 7b); every compression/extension of the suspension can be detected as displacement from the rest condition.

The HONDA 37870-MAT-E01 thermistor is used for monitoring the temperature of cooling liquid; this NTC thermistor shows a resistance value of $440\ \Omega$ at room temperature (25°C). The transducer is connected to the engine control unit, therefore, this last communicates sensors data to the Nucleo board by means of the Sparkfun CAN-BUS interfacing board (as shown in Fig. 8).

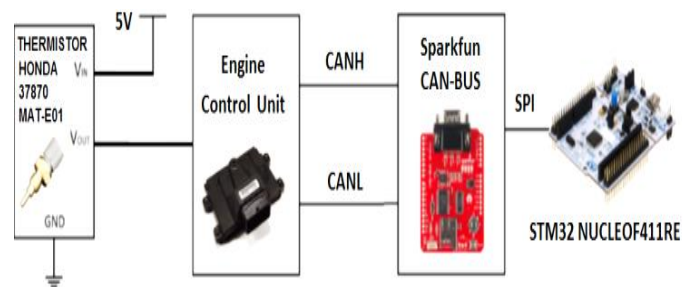

Fig. 8. Connection between the ST Nucleo development board and the thermistor Honda 37870 MAT-E01 through the Sparkfun CAN module.

The CHERRY GS1001 is a digital Hall effect sensor used for measuring of the rotational speed of mechanical objects such as trees, phonic wheels or fans. This module employs an internal Hall sensor, for detecting the presence of a magnetized metal object and, thus, providing an output signal proportional to the intensity of magnetic field that intercepts it. The Hall effect sensor is placed near to a phonic wheel connected to the wheels of the car (Fig. 9b); therefore, during the wheels rotation, the Hall sensors detect presence/absence of the phonic wheel's teeth, thus, allowing to get the rotational speed of the wheel and then the linear velocity of the vehicle.

The phonic wheel dimensions are: radius of 25.7 cm, teeth number equal to 24 and wheel circumference 1.614 m. Therefore, for each complete cycle, the vehicle travels a distance of 1.614 m. The speed of 200 km/h (55.56 m/s) corresponds to 34.43 cycle/sec of the phonic wheel (i.e. 827 teeth per sec); hence from 0 up to 200km/h, the teeth passing frequency changes from 0 to 0.827 kHz. The CHERRY GS1001 Hall sensor has a maximum detection frequency of 15kHz, therefore fully satisfies required specifications [16].

The sensor output is connected to the engine control unit (Fig. 10); it performs a signal filtering and processing operation for converting the frequency of alternative signal produced in output from the Hall sensor, in the vehicle speed value. This value can be acquired from the prototyping board, by means of the Sparkfun CAN board.

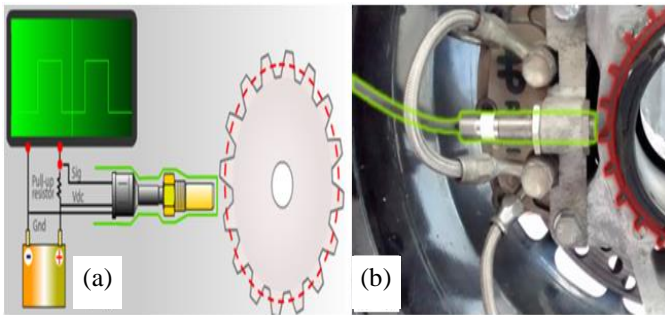

Fig. 9. Schematic representation of the Hall effect sensor for measuring of the vehicle speed (a) and a real photo with the Hall sensor (green) properly positioned for detecting the rotation speed of the wheel (red) (b).

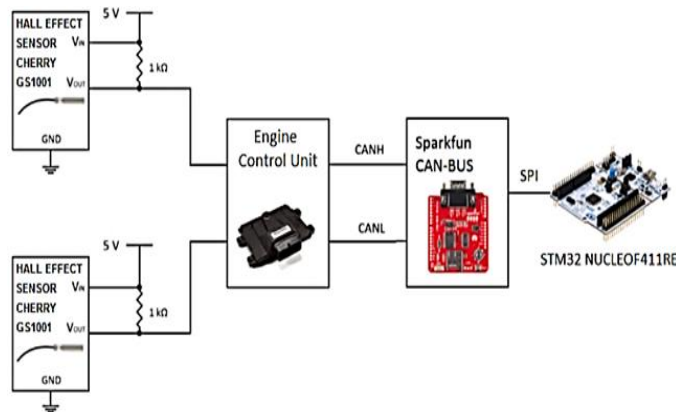

Fig. 10. ST Nucleo board and Cherry GS1001 Hall sensors connections: the communication is performed through the Sparkfun CAN module.

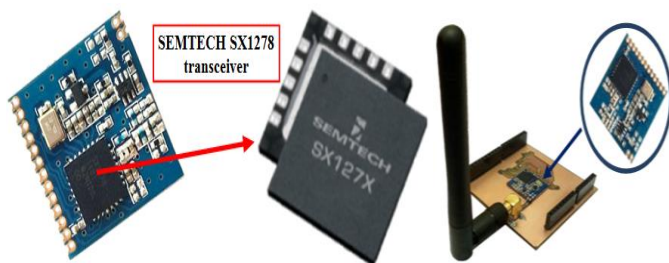

Fig. 11. DORJI DRF1278F Wi-Fi radio module with SEMTECH SX1278 transceiver (a) and top side of the realized board for interfacing of the Wi-Fi radio module with ST Nucleo board; an antenna is used for the Wi-Fi transmission (b).

The DRF1278F is a Wi-Fi radio module based on the SX1278 transceiver, shown in Fig. 11a, from Semtech Corporation. The SX1278 transceiver exploits LoRa (Long Range) modulation presenting high sensitivity (-139 dBm) and 20 dBm power output. DORJI DRF1278F Wi-Fi radio module requires a power supply from 1.8V to 3.6V and exhibits extra low standby current which makes it suitable for battery-powered applications.

The SX1278 transceiver integrates a high selectivity receiver with very linear front end ($iip3 = 11$ dBm), featured by low power consumption compared to other similar system. The DRF1278F Wi-Fi radio module was soldered on an adapting board for interfacing it with the STM Nucleo board (Fig. 11b); in this way, the WiFi module pitch (1.27 mm) was

adapted to STM Nucleo pitch (i.e. 2.54mm). Also the antenna, through a SMA RF connector, was connected to the DRF1278F radio module [2,3].

On the realized PCB for signals conditioning, the components and previously discussed electronic modules are housed and connected together (Fig. 3). The PCB hosts the needed components for adjusting the signals level for the Nucleo board, provided by LM35 temperature sensors, besides the ST HCF4051 multiplexer. Two black connectors (20 pins each), visible on the right, are soldered on board for connections with the four LM35 sensors and four IXTHUS potentiometers. The HONDA thermistor and two Hall sensors are connected to the engine control unit that communicates with Sparkfun CAN module through CANL and CANH channels. Different pins of the black connectors were left free to easily make future improvements or to add further sensors.

C. Developed firmware for the detection and wireless sending of vehicle parameters

The implemented firmware, developed in C++ language and installed into the STM32F411RET6 microcontroller, allows the reading operations from the sensors besides the management of the Sparkfun CAN BUS and Wi-Fi modules. It is composed, in the main section, of one iteration cycle for performing the needed operations such as data collection, storage on the SD memory card and data transmission wirelessly. Check-up operations are the first implemented in the firmware (section a of flow chart in Fig. 12): these consist in an initialization phase of all employed modules in order to verify their proper connection. If in this phase, some problems occur, a LED, placed in the passenger compartment, is activated for error warning.

Subsequently, if a further initialization operation fails, the system provides for the timely and repeated communication, to the user, of the modules malfunction, so avoiding to collect wrong data. After initialization phase, the reading operations are performed; in this phase, all data are acquired, from the sensors directly connected to the STM Nucleo board and from sensors connected through the Sparkfun CAN module. Also in this case, if errors occur, a LED is used to warn the user and the value -1 is assigned to the data provided from CAN module. The developed firmware proceeds with the data storage on the SD memory card and the wireless data transmission; different controls, for checking possible errors presence, are carried out. In particular, if the data storage is not possible, an intermittent LED, related to writing operation on SD memory card, is activated; the sensors data are sent anyway wirelessly (if the Wi-Fi module operates correctly), to be saved on the base station. On the contrary, if the wireless transmission is not working but it is possible the storage data on the SD memory card, the acquired data remains stored to be analyzed afterwards.

Finally, if both the Sparkfun CAN-BUS and Wi-Fi radio modules don't work properly persistently, then the system communicates the error through signaling LEDs, soliciting the technical staff intervention. In this way, the implemented telemetry system results particularly stable and reliable.

On the receiving side, as well as for data transmission, the DRF1278F Wi-Fi module is initialized; afterwards, the

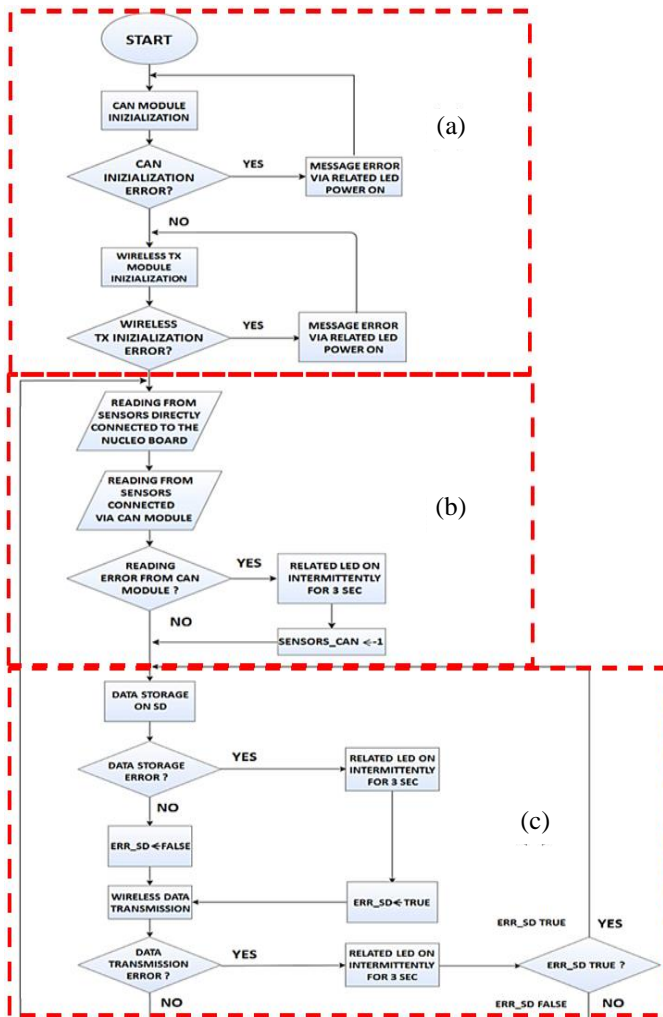

Fig. 12. Firmware flow chart: in the section (a), CAN and WiFi modules are initialized; in section (b), reading operations are performed from sensors connected directly to Nucleo board or via CAN module. In third section (c), detected data are stored on memory card and sent via WiFi to base station.

transmitted data are received from the base station and displayed on the PC connected, via an USB cable, with the STM Nucleo board.

Different test phases were carried out for verifying the correct operation of each component of realized telemetry system. The IXTHUS linear potentiometers require a supply voltage of 3.3V and provide an output voltage ranging from 0 to 3.3V, as function of assumed position (totally compressed 0V, maximum extension 3.3V); this analog output was connected to the ADC input pin (PA1) of STM Nucleo board, which, connected to PC through USB cable, allowed to verify the proper functioning of the sensor. The LM35 temperature sensors require a supply voltage of 5V and provide an analog output function of the detected temperature; therefore, connected to PC4 analog input pin of STM Nucleo board, the provided voltage was acquired for verifying the correct operation of the temperature sensors. Also the multiplexer operation, employed to select the specific LM35 sensor, was checked.

In order to test the CAN module functioning, the cooling liquid temperature was acquired during engine operation. The used HONDA NTC thermistor, by means of the CAN module,

provided data to the STM Nucleo board; these data were stored on the SD memory card, together with values acquired by the LM35 temperature sensors, IXTHUS potentiometers and those related to the GS1001 Hall sensors.

Last test regards the DORJI DRF1278F WiFi radio module operation. Data packets were transmitted every 10ms; the maximum distance between the transmitting and receiving DRF1278F modules, to avoid data losses, was of 1.2 km in the carried out tests of the telemetry system. Also, for experimental tests, a place with some buildings was chosen, thus considering a worst case; result was satisfactory, since usually there are not buildings in the racing track and only 500-800m was the target distance to be reached.

III. RESULTS AND DISCUSSION

In this paragraph, the testing of the assembled telemetry system is reported; sensors and data acquisition/ transmission control unit were mounted on the vehicle. On the receiver side, data are collected wirelessly by the DORJI DRF1278F WiFi radio module and, by means of STM32 Nucleo board, visualized on a PC terminal; data provided by the different sensors were stored on SD memory card and then sent wirelessly to base station. In Fig. 13, the values, received from base station, related to engine temperature are plotted for a time interval [0 – 2500] sec; the four curves, one for each LM35 sensor, show the engine temperature trend as function of the engine rpm (revolutions per minute) variations. As shown in Fig. 13, engine rpm are increased initially at 1000sec, resulting in an increase of temperature from $\approx 23^{\circ}\text{C}$ to $28-32^{\circ}\text{C}$; then, between 1100 and 1300sec, the rpm are kept constant and temperature remains unchanged. Then the engine rpm are again increased and temperature values reach $39-44^{\circ}\text{C}$ and so on.

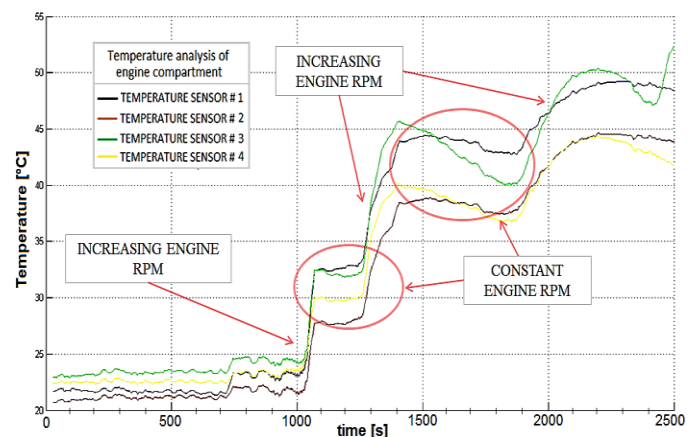

Fig. 13. Graphs as function of time of the four LM35 temperature sensors positioned in the engine compartment, varying the engine rpm value.

The plots reporting the vehicle speed are shown in Fig. 14. The speed data, as previously described, are acquired by the GS1001 Hall sensors, mounted close to phonic wheels attached to the front and rear wheels of the vehicle. Hall sensors are connected to the engine control unit which performs the conversion operation from teeth number passing/sec in front of Hall sensor, to vehicle speed value in km/h. Afterwards, by

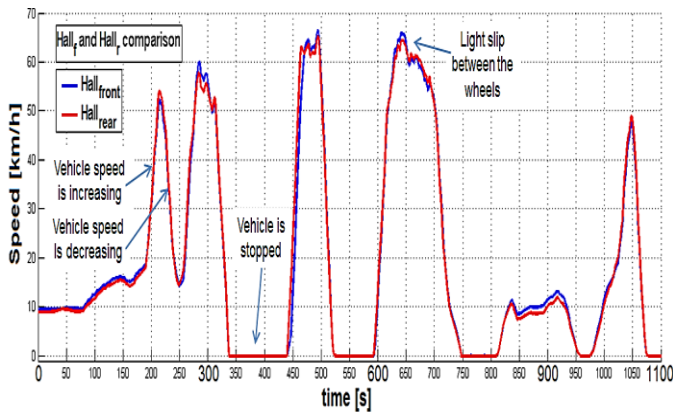

Fig. 14. Graphs relative to the speed values, received wirelessly from base station, acquired by Hall sensors mounted on vehicle front and rear wheels.

means of CAN module, calculated speed values are sent to the Nucleo board and then, wirelessly through the DORJI WiFi radio module, to the base station. The received data are sent by serial communication to PC terminal for displaying them. As shown in Fig. 14, between 180 and 220 seconds the vehicle speed rapidly increases reaching 53km/h and then decreases until to 15km/h.

As expected, the two curves, one related to rear Hall sensor (red) and the other to front Hall sensor (blue), are perfectly overlapped. However in some intervals, the two curves are slightly different, for example around 300, 480 or 650 seconds or in the time interval [850–930] seconds; this not perfect alignment is due to a slight slip of wheels, that occurs when vehicle is going through a curve or to uneven asphalt or to an abrupt steering of the vehicle.

The graphs of Fig. 15 report the data related to IXTHUS linear potentiometers installed on the front-left and front-right suspensions and directly connected to STM Nucleo board. It acquires the provided analog signals and, after a processing phase to obtain extension value in mm, by means of WiFi module, sends extension data to the base station.

By analyzing suspensions' extension data, it is possible to determine if the vehicle is in curve or is performing an abrupt maneuver. For example, in the interval [80-230] sec, the front-right potentiometer is extending whereas front-left one is compressed, meaning that vehicle is running a curve on the right. At ≈230seconds, the pilot performs an abrupt steering on the left, causing the compression of the front-right potentiometer (≈ 5.5mm) and the extension of the front-left one (same variation).

By comparing Fig. 14, which reports the vehicle speed trends, with Fig. 15, it can be noted that when vehicle speed is zero (i.e. in the intervals [340-440], [520-590], [750-810] and [950-970] seconds), potentiometers are at rest assuming the same position (≈18mm) of initial instants. With moving vehicle, when the speed rapidly decreases before a curve (e.g ≈ 250 seconds), just after the suspensions' extension reaches high values.

Also by comparing the vehicle speed trends with curve reported in Fig. 16 relative to the temperature of cooling liquid, it can be noted that when vehicle is stopped, an increase of the liquid temperature occurs. In fact, with moving vehicle, the air flow contributes to decrease the liquid temperature, as

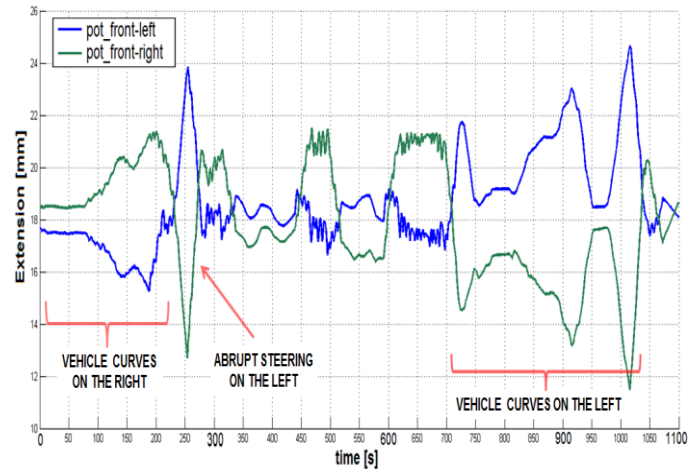

Fig. 15. Graphs related to extension data provided by linear potentiometers (blue for the front-left suspension, green for front-right one).

evident for instance in the range [600 - 700] seconds. The temperature of cooling liquid increases also in the time interval [700 - 900] seconds, due to the low vehicle speed for so long time.

The wirelessly received data confirm that both electronic units, the transmitting one mounted on vehicle and the receiving one located to the base station, work properly. The sensors data are correlated between themselves indicating that realized telemetry system allows to monitor and control correctly the different parameters involved during vehicle motion. Differently from other systems available on market, more sophisticated but with much higher costs, the telemetry system here proposed, able to monitor constantly and in real time the vehicle parameters and to reliably send all data to a base station, is constituted by sensors and electronic boards with very low cost and all commonly available on the market.

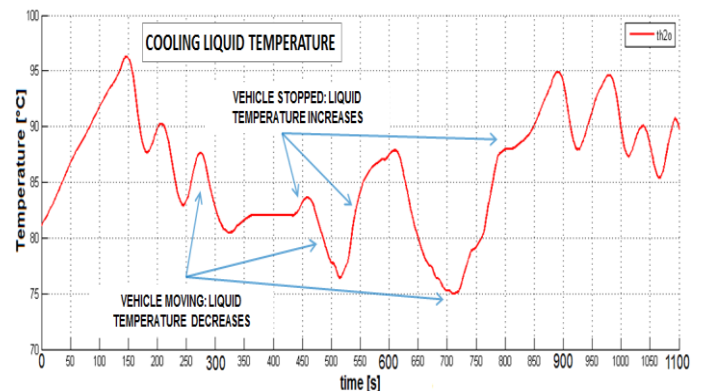

Fig. 16. Graph of cooling liquid temperature changing with vehicle motion; comparing with the vehicle speed trends, when the vehicle is stopped, the liquid temperature increases and vice-versa when vehicle is moving.

IV. CONCLUSION

In this paper, a telemetry system for a continuous and real time monitoring of the principal parameters involved during the SRT16 motion (a single-seat Formula SAE car developed by Salento racing team) was proposed. The system is composed of several sensors: LM35 temperature sensors, thermistor for cooling liquid temperature, Hall effect speed

sensors and potentiometers for suspensions' extension detection. The data relative to physical and mechanical quantities, are acquired and processed by a control board, based on a STM32 Nucleo board, programmed with firmware properly developed for this application. The control unit, through a WiFi radio module, transmits the sensors data to the WiFi receiver unit located into the base station where, by means of another ST Nucleo board connected via USB to PC, the data are displayed on a PC terminal. Another used electronic board is the Sparkfun CAN-BUS shield, that interfaces the Nucleo board and engine control unit and locally stores all acquired data on a SD card.

Carried out tests demonstrated that the telemetry system works properly; all received data are in accordance between themselves, reporting the vehicle parameters as function of the different driving and track conditions. This allows, making use of a low cost telemetry system, to monitor and control, in reliable and accurate way, the desired physical and mechanical parameters, thus giving the possibility to the technical staff to intervene in case of malfunctioning, safeguarding pilot life and vehicle integrity.

REFERENCES

- [1] J. Elliot, "Telemetry helps Formula SAE team close the loop on design-SAE International," *Momentum, the Magazine for Student Members of SAE International*, vol. 3, no. 5, pp. 7-9, 2012.
- [2] P. Visconti, P. Primiceri and C. Orlando, "Solar Powered Wireless Monitoring System of Environmental Conditions for Early Flood Prediction or Optimized Irrigation in Agriculture," *Journal of Engineering and Applied Sciences*, vol. 11, no. 7, pp. 4623-4632, 2016. DOI: 10.13140/RG.2.2.35123.63526
- [3] P. Visconti, P. Primiceri and G. Cavallera, "Wireless Monitoring System of Household Electrical Consumption with DALY-based Control Unit of Lighting Facilities Remotely Controlled by Internet," *Journal of Communications Software and Systems*, vol. 12, no. 1, pp. 4-15, 2016. DOI: 10.24138/jcomss.v12i1.86
- [4] X. Huang, Y. Tan and X. He, "An Intelligent Multifeature Statistical Approach for the Discrimination of Driving Conditions of a Hybrid Electric Vehicle," *IEEE Transactions on Intelligent Transportation Systems*, vol. 12, no. 2, pp. 453-465, 2011. DOI: 10.1109/TITS.2010.2093129
- [5] E. Önlcr, S. Çelen, A. Moralar and H. Çelen, "Development of telemetry system for electric powered vehicle," *International Journal of Current Research*, vol. 8, no. 9, pp. 38715-38719, 2016.
- [6] A. Vijayan and S. Babu, "An efficient Data Acquisition System for Launch Vehicle Telemetry," *International Journal of Science and Research*, vol. 4, no. 7, pp. 1693-1699, 2015.
- [7] E. Walter, N. Glover, J. Cureton and K. Kosbar, "Telemetry System Architecture for a Solar Car," in *International Telemetering Conference Proceedings*, Las Vegas, 2015, pp. 1-9.
- [8] U. Satija, B. Ramkumar and M. S. Manikandan, "Real-Time Signal Quality-Aware ECG Telemetry System for IoT-Based Health Care Monitoring," *IEEE Internet of Things Journal*, vol. 4, no. 3, pp. 815-823, 2017. DOI: 10.1109/JIOT.2017.2670022
- [9] W. A. Martins, M. L. R. de Campos, C. R. da Silva, C. P. V. Lordelo, A. Ellmauthaler, L. O. Nunes and D. A. Barfoot, "Communication Models for Distributed Acoustic Sensing for Telemetry," *IEEE Sensors Journal*, vol. 17, no. 15, pp. 4677-4688, 2017. DOI: 10.1109/JSEN.2017.2714023
- [10] M. A. Rahman, J. Ali, M. N. Kabir and S. Azad, "A performance investigation on IoT enabled intra- vehicular wireless sensor networks," *International Journal of Automotive and Mechanical Engineering*, vol. 14, no. 1, pp. 3970-3984, 2017. DOI: 10.15282/ijame.14.1.2017.12.0322
- [11] P. Primiceri, P. Visconti, A. Melpignano, G. Colleoni and A. Vilei, "Hardware and Software Solution Developed in Arm Mbed Environment for Driving and Controlling DC Brushless Motors based on ST XNUCLEO Development Boards," *Int. J. on Smart Sensing and Intelligent Systems*, vol. 9, no. 3, pp. 1534-1562, 2016. DOI: 10.21307/ijssis-2017-929
- [12] P. Visconti, A. Lay-Ekuakille, P. Primiceri, G. Ciccarese and R. de Fazio, "Hardware Design and Software Development for a White LED-Based Experimental Spectrophotometer Managed by a PIC-Based Control System," *IEEE Sensors Journal*, vol. 17, no. 8, pp. 2507-2515, 2017. DOI: 10.1109/JSEN.2017.2669529
- [13] S. Vijayalakshmi, "Vehicle control system implementation Using CAN protocol," *International Journal of Advanced Research in Electrical, Electronics and Instrumentation Engineering*, vol. 2, no. 6, pp. 2532-2538, 2013.
- [14] SparkFun Electronics, "CAN-BUS Shield - DEV-13262," SparkFun Electronics, Tech. Doc., Mar, 2017.
- [15] Gefran, "PZ12 Rectilinear displacement transducer with cylindrical case", Gefran, Tech. Doc., Jun, 2016.
- [16] ZF Switches and Sensors, "Speed Sensors GS1001-1002," ZF Switches and Sensor, Tech. Doc., Nov., 2017.