



Abdelbaki Elmahi ¹, Touhami Baki ¹, Mohamed Tebbal¹

New analysis of experimental data of the hydrodynamic liquid film around jet zone on horizontal plate

Optimization of cooling systems is of major importance due to the economy of cooling water and energy in thermal installations in the industry. The hydrodynamic study of the film is a prerequisite for the study of the intensity of the heat transfer during the cooling of a horizontal plate by a liquid film. This experimental work made it possible to quantify the hydrodynamic parameters by a new approach, a relation linking the thickness of the film to the velocity was found as a function of the geometrical and hydrodynamic characteristics of the sprayer.

A new statistical approach has been developed for the measurement of the velocity, the liquid fluid arriving at the edge of the plate and having velocity V is spilled out like a projectile. The recovering of the liquid in tubes allowed us to quantify flow rates for different heights positions relative to the plate, statistical processing permitted us to assess the probable velocity with a margin of error.

Nomenclature

a	larger diameter of the opening of the sprayer, mm
b	small diameter of the opening of the sprayer, mm
c	thickness of the bottom sprayer, mm
g	gravitational acceleration, m/s^2
g'	fluid dispersion, $\text{mm}^3/\text{mm}^2 \text{ s}$
H	height between the nozzle and the wetted surface, mm
h	depth of the slot sprayer, mm
K_1	hydrodynamic statistical parameter, $\text{kg/m}^2\text{s}$

✉ Abdelbaki Elmahi, e-mail: abdelbaki.elmahi@univ-usto.dz

¹Faculty of Mechanics, Gaseous Fuels and Environment Laboratory, University of Sciences and Technology of Oran Mohamed Boudiaf (USTO-MB), El Mnaouer, Oran, Algeria. ORCID: A.E.: 0000-0002-6639-8360; T.B.: 0000-0003-0246-0281



© 2021. The Author(s). This is an open-access article distributed under the terms of the Creative Commons Attribution-NonCommercial-NoDerivatives License (CC BY-NC-ND 4.0, <https://creativecommons.org/licenses/by-nc-nd/4.0/>), which permits use, distribution, and reproduction in any medium, provided that the Article is properly cited, the use is non-commercial, and no modifications or adaptations are made.

K_2	geometrical statistical parameter, mm
L	distance between the limit of the ellipse and the boundary of the plate, mm
ΔP	pressure variation, MPa
Q_v	volume flow rate, m ³ /s
R	internal radius of the sprayer channel, mm
r	geometrical parameter, mm
S	section of the opening of the sprayer, mm ²
t	time, s
V_0	initial velocity of the liquid film as it leaves the plate, m/s
V	velocity of liquid film, m/s

Greek symbols

φ	angle of opening of the sprayer, deg
δ	thickness of liquid film, mm
ρ	density, kg/m ³
μ	average of the curve
σ	standard deviation of the curve
σ_x	variance to the x -axis
σ_y	variance to the y -axis
ξ	geometrical parameter ($\xi = h - c/2R$)

Subscripts

max maximum

1. Introduction

Liquid films flowing on a surface are observed in a wide variety of natural phenomena and are also used in industrial processes for their high thermal efficiency. Liquid films falling on vertical or inclined surfaces under the influence of gravity find their applications in condensers, evaporators, chemical reactors, and absorbers and in the cooling of the highly heated horizontal plates in the steel production field.

Jet cooling has evolved considerably over the past decades; it has a significant impact on the formation of the structure of materials, its mastery has made it possible to predict the local and average heat flow on the heated surface. Spray cooling is very common in the field of steel preparation; Abbasi [1] obtained that the heat transfer depends on the local mass flow rate of spraying; and that dispersed fluids play a very important role in obtaining metals and steels with specific characteristics, according to Bratuta and Zanothchkin [2]. The dispersion of the fluid is one of the main factors determining the intensity of heat transfer during cooling with all its complexity, namely the quantification of the dispersed volume V per unit area S and the unit of time (s) according to Tebbal [3].

Numerous experimental studies have been carried out in the field of spray cooling. Ambrosini et al. [4, 5] carried out an experimental study on the cooling of heated surfaces by the evaporation of thin films of water falling freely on a flat vertical or inclined plate, under laminar, transition and turbulent regimes, and analyzed the film wave velocity.

Adomeit and Renz [6] observed the wave morphology of the film flow. They found remarkable changes in flow behavior and wave structure when the Reynolds number is near a certain transition point, and they used the PIV (Particle Image Velocity) method to measure the velocity of the liquid film; this method has also been used by other authors [7–9].

Takamasa and Hazuku [10] presented experimentally a new way of measuring the interfacial waves, thickness, and velocity of the film flowing down a vertical plate in an entry region, using two laser focus displacement meters. The results of wave velocity and maximum film thickness show a good agreement with previous experimental and theoretical studies.

Moran et al. [11] experimented with the characteristics of laminar films of silicone oil on an inclined plate, with Reynolds number varying from 11 to 220. They found that the average and maximum velocity data are considerably overestimated by the Nusselt theory, while the film thickness data is slightly underestimated. Tebbal and Mzad [12] experimentally studied the profiles of water jets under liquid sprayers on flat surfaces; correlations were established and compared to the data found. Mzad and Tebbal [13] carried out a simulation for eight different sprayers in the pressure range of the ejected fluid, lying between 1 and 3 bars. The experimental data are used to study the influence of the water dispersion function $g(x, y)$, and curves of the temperature variation have been generated.

Benilov et al. [14] analyzed two problems of the liquid film on an inclined plate, the liquid layer flowing along with a plate, and the entrainment condition of the films. They used many methods to measure the velocity and the thickness of the liquid film. Huang et al. [15] built an experimental system to investigate the countercurrent flow of water-air in a large-scale rectangular rotatable channel. Their experiment results show that the droplet entrainment, coursed by the high-velocity airflow tearing off the large surface waves would reduce the average film thickness significantly, especially for vertical plate condition; the increasing Reynolds number lead to appear wave which contains much liquid mass.

Yu and Cheng [16] performed an experimental study of free-falling water film flow on a vertical and an inclined flat plate with different Reynolds number (50–3600). The results show that with the increase of Reynolds number, the solitary waves of film flow develop from low-velocity waves of high frequency and short wave length to high-velocity waves of low frequency and long wave length. Mzad and Elguerri [17] accomplished a hydrodynamic investigation using a program of simulation based on the experimental correlations of pulverized water in the intersection area of jets. Choual and Tebbal [18] demonstrated experimentally that the fluid dispersion in the intersection jet area is different from the dispersion

obtained by summation of both jets for different hydraulic atomizers. Du et al. [19] carried out an experimental analysis to study the falling water film flow on the large-scale ellipsoidal surface under Reynolds number varying between 360 and 2175. They proposed a new empirical correlation of film thickness on the ellipsoid dome surface that gives a good agreement with other correlations of film thickness reported in the literature.

Tibiriça et al. [20] used two methods to measure liquid film thickness during condensation and evaporation under macro and micro-scale conditions. They found that the micro-scale method was able to measure thin films. Ouldrebaï et al. [21] proposed a method based on the reflection of light to measure the thickness of a liquid film flowing on an inclined plane in several positions. On the other hand, Cai and Zhuo [22] studied the hydrodynamics of the flow of the liquid film on an inclined plate numerically. Their results show that as the angle of inclination of the plate increases, the wet-ability of the liquid film deteriorates, which can lead to splashing droplets.

Quantification of hydrodynamic parameters such as flow velocity and film thickness are critical in assessing the intensity of heat transfer during the cooling of heavily heated plates. In this study, an experimental set-up allowed us to plot the velocity profile of the liquid film at the edge of the horizontal plate. We used a new approach to measure the velocity of the fluid; by statistical processing, we linked the velocity profile to the flow rate. By using the correlations of Tebbal and Mzad [12] parameterizing the jet impacting a horizontal plate, we established a relation linking the thickness of the film to the geometric and hydrodynamic characteristics of the sprayer.

2. Experimental device

An experimental device was developed, equipped with a sprayer impacting a jet on a horizontal plate with variable height H , as shown in Fig. 1. The sprayer used is a cylindrical channel with a spherical bottom, a slot with a conical profile is made inside. The geometrical parameters of the sprayer are detailed in Fig. 1. The surface impacted by the jet is an ellipse, with dimensions x_{\max} and y_{\max} .

From the geometrical characteristics of the sprayer, the opening cross-section of the exit surface of the jet is determined, we have then:

$$a = 2(h - c) \tan \frac{\varphi}{2}, \quad (1)$$

$$b = 2 \left(2 [R - (h - c) + hc] - h^2 - c^2 \right)^{1/2}. \quad (2)$$

The cross-sectional area of the opening of the nozzle S is:

$$S = 0.0349 \arctan \left(\frac{br^2}{2r - a} \right) - b \left(r - \frac{a}{2} \right) \quad (3)$$

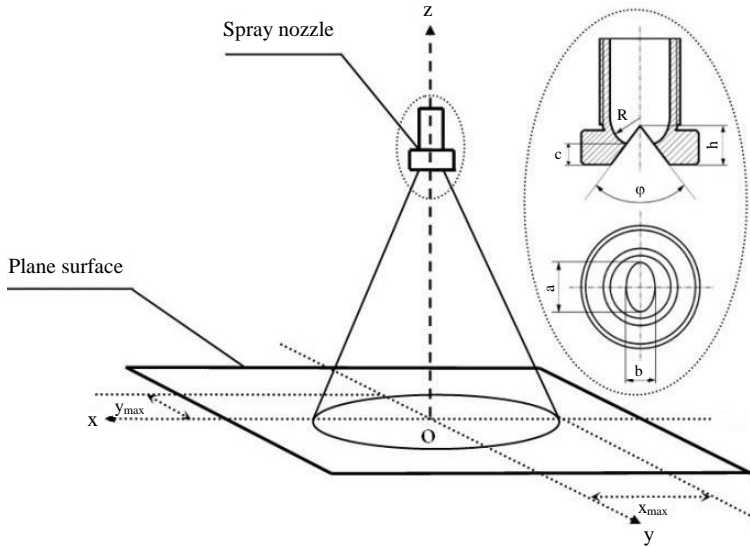

Fig. 1. Schematic of the experimental device

with

$$r = \frac{a^2 + b^2}{4} \tag{4}$$

and

$$\xi = \frac{h - cr}{2R} . \tag{5}$$

This same device was used for the study of the jet in the zone I of impact by Tebbal and Mzad [12] (see Fig. 2). In our experiment, we are interested in studying the hydrodynamics of film on zone II indicated in the same figure.

The forming of the liquid film in zone II depends on the geometrical parameters and also the hydrodynamic conditions, according to Bratura and Tebbal [23], such as the height H between the sprayer and the surface of the plate, and the variation of the sprayer pressure ΔP as pointed out by Patrick et al. [24], the distance L between the limit of the ellipse and the boundary of the horizontal plate, that is actually the width of zone II. The plate dimensions are $1\text{ m} \times 1\text{ m}$, and the length L is equal to 300 mm . The study concerns the action of the liquid film outside the impact surface, in zone II, in order to quantify the film's hydrodynamic parameters, namely the average flow velocity and thickness.

On the extension of the fluid flow along the y -axis of the plate, as shown in Fig. 1, we placed a battery of tubes to collect the volume V of water projected for a time t . The battery extends for a width along the Y axis and is at a height X from the level of the plate. Several attempts have been made for different X heights; the detail of the battery's position is shown in Fig. 3.

The liquid film recovery battery is made up of several graduated tubes as shown in Fig. 4.

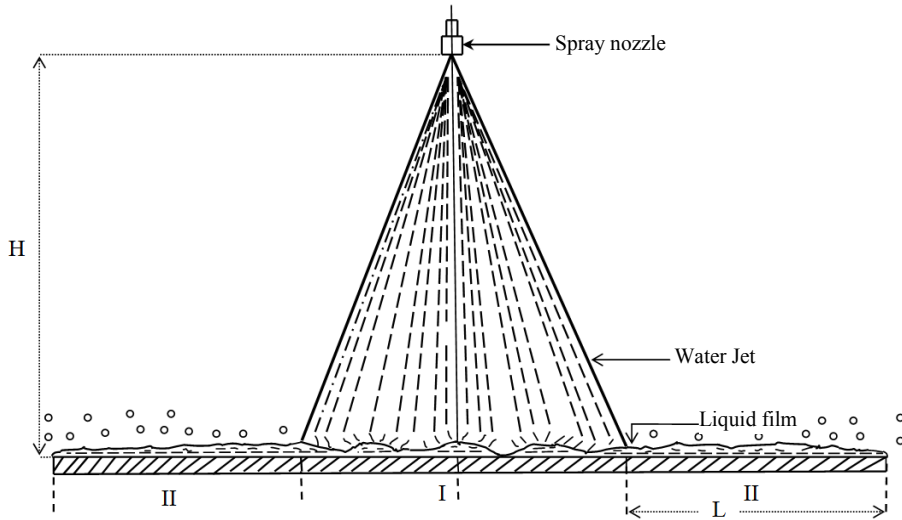

Fig. 2. Diagram showing the study area

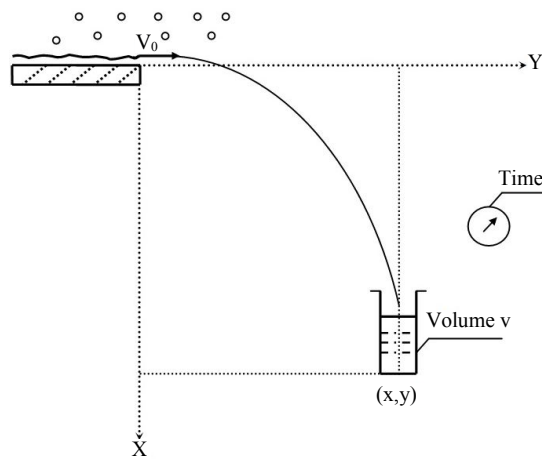

Fig. 3. Positioning of the collection battery

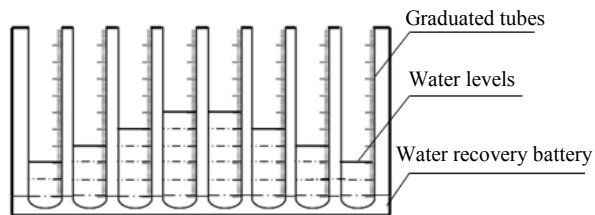

Fig. 4. Battery of the tubes

Each tube will have collected a volume V for a time t ; the calculated ratio $Q_v = \frac{V}{t}$ represents the flow rate. It was between 0 and $0.267 \cdot 10^{-6} \text{ m}^3/\text{s}$. The collecting battery was positioned over a distance Y between 0 and 350 mm of the plate edge. Three series of measurements were adopted for values of the height X of 60, 80, and 100 mm. All these experiments were executed for known hydrodynamic parameters $H = 400 \text{ mm}$, $\Delta P = 0.32 \text{ MPa}$. The geometrical characteristics of the sprayer are defined in the following Table 1.

Table 1.

The geometric parameters of the used sprayer

φ (degree)	h (mm)	b (mm)	a (mm)	S (mm ²)	ξ
60°	6.5	6.03	17.235	180	0.225

3. Results and discussions

3.1. Presentation of the projectile method

The projectile method is a technique for measuring the velocity of the fluid on the extension of the current line. The elementary particle of fluid arriving at the edge of the plate and having a velocity V_0 will be projected by describing a parabola, the collection of volumes of fluid in tubes for a duration t will allow us to determine the flow rate Q_v passing at the point of collection (X, Y) . The operation will be repeated at different heights X from the level of the plate.

The recovery of the data and their processing will lead us to plot the flow rate of the fluid as a function of the velocity; the profile obtained follows a normal law. Statistical analysis will determine the mean value of the fluid flow velocity and the standard deviation.

Particle Image Velocimetry (PIV) is a measurement technique that appeared at the end of the 1970s. It allows access to the instantaneous velocity field. The local velocity of the fluid is measured by recording images of the tracer particles introduced into the flow and determining the distance traveled by these particles and the time between the successive images of the same particle.

The projectile method is a manual assembly that does not require tracers in the fluid, the velocity is obtained by a statistical approach, giving the average with a margin; the assembly can only be done if the fluid is poured beyond the plate. On the other hand, the PIV method is more precise and equipped with automatic signal processing; the fluid must be loaded with fluorescent particles, the velocity can be determined in a channel on the surface.

Projectile method procedure

1. Installation of a collection tubes assembly shown in Fig. 4 on the fluid discharge path positioned at (X, Y) on the reference in Fig. 3.
2. Repeat at X -height positions the same as part 1.

3. Record data on volumes collected for a specific period t .
4. Draw curves on the same graph, giving the flow rate Q_v as a function of Y , for different X positions.
5. Calculate the corresponding velocity V for each point (X, Y) and plot the flow rate Q_v curve as a function of the fluid velocity V .
6. Determination of the average velocity V by statistical analyzes of the data, using the normal law.

3.2. Data analysis

The result of the experiments is shown in Fig. 5 indicating the flow rate as a function of the distance Y from the edge of the plate, three bell-shaped curves each representing a given height X . When $X = 60$ mm, Y ranges from 65.40 to 261.53 mm, when $X = 80$ mm, Y takes values from 74.90 to 275.80 mm; and when X is 100 mm, Y is between 86.54 and 302.67. The values of the flow rate pass through peaks of 0.267×10^{-6} at $X = 60$, then 0.227×10^{-6} at $X = 80$ and finally 0.203×10^{-6} at $X = 100$ mm.

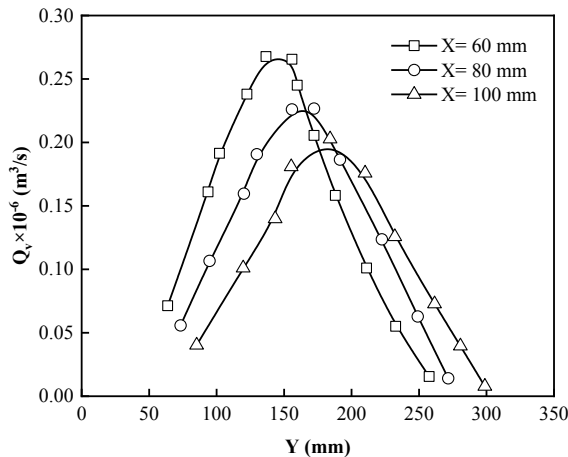

Fig. 5. Experimental data for different values of X

The three curves of Fig. 5 have the same shape and are offset with respect to each other, when Y increases, the flow rate increases, passes through a peak, and then decreases; as X increases, the peak of the curve in question decreases and passes to the right, the more X increases, the more the curve widens and flattens.

The elementary quantity arriving at the edge of the plate has a velocity V_0 is projected by describing a parabola, then it is recovered in the tubes. The distance passing through the axis Y is determined by the relation:

$$Y = V_0 t \quad (6)$$

and the distance passing through the X axis is:

$$X = \frac{1}{2}gt^2. \tag{7}$$

From Eqs. 6 and 7 we obtain:

$$V_0 = Y\sqrt{\frac{g}{2X}}. \tag{8}$$

For each point of the curves of Fig. 5, corresponding to a couple (X, Y) , and a given flow rate Q_v , the velocity V_0 of the point (X, Y) can be determined, we then draw the curves giving the flow rate as a function of the velocity, see Fig. 6.

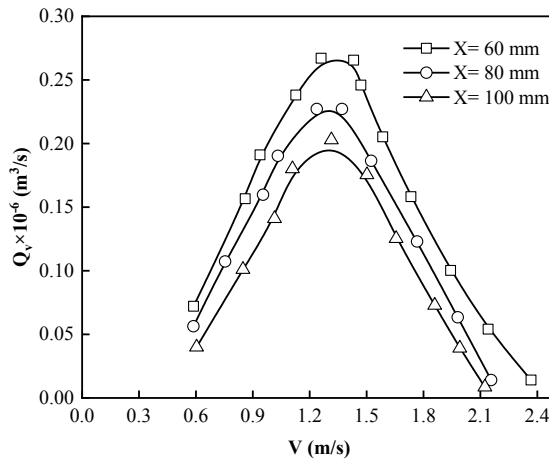

Fig. 6. Velocity action as a function of flow rate

Fig. 6 represents the relationship between the velocity and the flow rate, for the same value of velocity $V = 1.34$ m/s, the flow rate is maximal and reaches the same peaks as those of Fig. 5. The three curves have the same form, and all obey the normal law. Consequently, the peak of the flow rate decreases when the height X increases but remains at a fixed V_0 value around 1.34 m/s; this velocity is therefore independent of the value of X .

3.3. Modeling the characteristics of the film

The grouping of the results presented in Fig. 7, using the properties of the normal distribution, gives us the probability density of the velocity for the most probable flow; it was calculated by Eq. (9). The mean velocity of the fluid is evaluated at $V = 1.34 \pm 0.51$ and covers 68% of the probability.

$$f(v) = \frac{1}{\sigma\sqrt{2\pi}} \exp\left(-\frac{(V - \mu)^2}{2\sigma^2}\right). \tag{9}$$

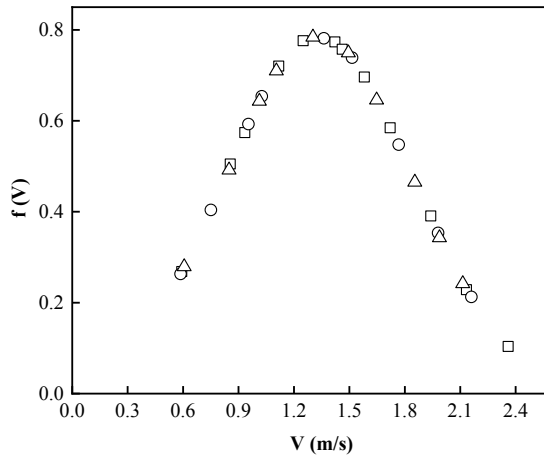

Fig. 7. The density function of the velocity probability

By linking the flow rate with the probability density of the velocity, we define the distribution function, as shown in Fig. 8, determined from Eq. (10):

$$F(v) = \frac{1}{2} \left(1 + \operatorname{erf} \left(\frac{V - \mu}{\sigma\sqrt{2}} \right) \right). \tag{10}$$

The curve of Fig. 8 shows the distribution function of the velocity profile, that is to say for each value of the flow velocity of the film correspond a real volumetric flow rate determined from the distribution function and the flow rate of the nozzle of the sprayer.

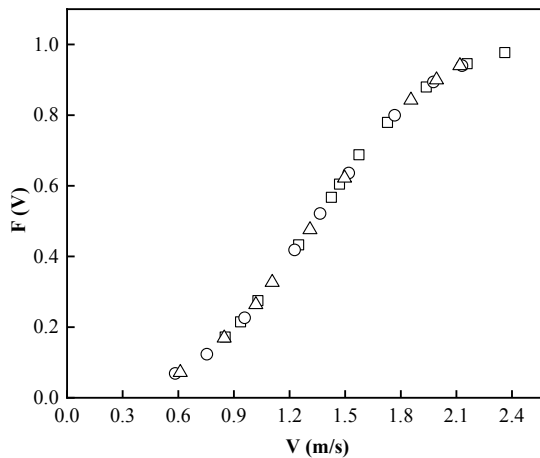

Fig. 8. The function of flow distribution as a function of velocity

3.4. Film thickness measurement

The flow rate emerging from the sprayer having the characteristics presented in Table 1 describes a jet impacting the plate on an elliptical surface. The characteristics of the jet were studied by Tebbal and Mzad [12]. They were able to model the dispersion field as a function of the installation's geometrical parameters and hydrodynamic characteristics. The distribution function is defined in the following form:

$$g'(x, y) = g'_{\max}(0) \exp \left[-0.5 \left(\frac{x_i^2}{x_{\max}^2 \sigma_x^2} + \frac{y_i^2}{y_{\max}^2 \sigma_y^2} \right) \right]. \quad (11)$$

Taking advantage of the properties of this function, it is possible to determine the flow rate leaving the sprayer and projected onto the plate. It can be obtained by the following relation:

$$Q_v = g'_{\max}(0) x_{\max} y_{\max}. \quad (12)$$

The flow rate calculation can be done by the correlations established by Tebbal and Mzad [12], giving the formulations of $g'_{\max}(0)$, x_{\max} and y_{\max} , listed below:

$$g'_{\max}(0) = 2.1039 K_1^{1.206} \zeta^{-0.702}, \quad (13)$$

where: $K_1 = S(2\Delta P \rho)^{0.5} H^{-2}$.

Meaning the experimental data, correlations are established to determine x_{\max} and y_{\max} which depend on the height H and $\tan(\varphi/2)$ and the cross-section of the sprayer orifice S , and are presented as follows:

$$x_{\max} = 2412 K_2^{-0.468}, \quad (14)$$

$$y_{\max} = 21.27 K_2^{0.062}, \quad (15)$$

where: $K_2 = H \tan \varphi/2$.

Knowing the hydrodynamic parameters chosen for the experiment, namely a pressure of $\Delta P = 0.32$ MPa and a height of $H = 400$ mm separating the nozzle from the plate and the geometrical parameters of the nozzle of Table 1, the flow rate out of the nozzle can be calculated.

This same flow impinging the plate will flow out of the sputtering zone, with a thickness δ and a velocity V arrived at the boundary of the plate. It will have the velocity V_0 of the projectile studied previously, this velocity is the same on the perimeter of the ellipse, away from the impact zone at a distance L .

The perimeter of the ellipse can be calculated with the formula (16):

$$P = 2\pi \sqrt{\frac{1}{2} \left((L + x_{\max})^2 + (L + y_{\max})^2 \right)}. \quad (16)$$

The outflow from the nozzle is calculated from Eq. (12). It will be the same at a distance L all around the impact zone and determined by Eq. (17).

$$Q_v = PV\delta. \quad (17)$$

By calculating the thickness of the liquid film with Eq. (17), and using the same velocity profile for the pressure of 0.16 and 0.64 MPa, we obtain the results illustrated in Fig. 9, which represent the thickness of the liquid film as a function of the volume flow.

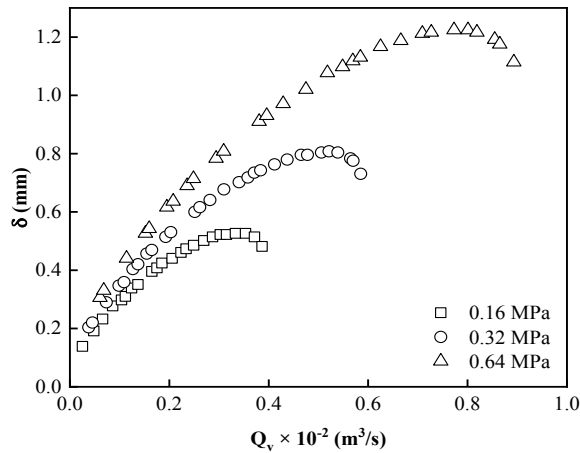

Fig. 9. Relationship between volume flow and film thickness

Fig. 9 shows the relationship between the volume flow rate and the thickness, the latter going to increase passing through a peak and then decrease when the flow rate leaving the sprayer increases. The three curves follow the same shape, only when the pressure difference increases, the thickness significantly increases, too.

4. Conclusion

The interest of this work is focused on the experimental hydrodynamic study of a liquid film on a horizontal plate located outside the area of the impact jet. A new approach permitted us to evaluate the probable average velocity with a margin of error of the liquid film pouring past the plate.

We have been able to establish that the velocity profile of the liquid spill out of the plate obeys a normal law, the pressure difference, and the height of the sprayer in relation to the plate influences the characteristics of the flow; we deduced the film thickness based on the geometric parameters of the sprayer and the hydrodynamic parameters of the installation, such as ΔP and H .

Acknowledgements

This study was supported by the Directorate General of Scientific Research and Technological Development under commend of the Algerian Ministry of Higher Education and Scientific Research.

Manuscript received by Editorial Board, June 02, 2021;
final version, August 20, 2021.

References

- [1] B. Abbasi. *Pressure-based prediction of spray cooling heat transfer*. Ph.D. Thesis, University of Maryland, College Park, USA, 2010.
- [2] E.G. Bratuta and L. Zanothkine. Intensification of heat transfer by dispersed fluids. *Machinos-traenia Energy*, 38(84):71–75, 1984. (in Russian).
- [3] M. Tebbal. Correlation of the thermal transfer coefficient and the dispersion of the fluid on a surface at high temperature. In: *5th International Meeting on Heat Transfer*, Monastir, Tunisia, 1991.
- [4] W. Ambrosini, N. Forgione, F. Oriolo, P. Vigni, and S. Baessler. Experimental investigation on wave velocity in a falling film. In: *2nd International Symposium on Two-phase Flow Modelling and Experimentation*, Pisa, Italy, May 23–26, 1999.
- [5] W. Ambrosini, N. Forgione, and F. Oriolo. Statistical characteristics of a water film falling down a flat plate at different inclinations and temperatures. *International Journal of Multiphase Flow*, 28(9):1521–1540, 2002. doi: [10.1016/S0301-9322\(02\)00039-3](https://doi.org/10.1016/S0301-9322(02)00039-3).
- [6] P. Adomeit and U. Renz. Hydrodynamics of three-dimensional waves in laminar falling films. *International Journal of Multiphase Flow*, 26(7):1183–1208, 2000. doi: [10.1016/S0301-9322\(99\)00079-8](https://doi.org/10.1016/S0301-9322(99)00079-8).
- [7] S.V. Alekseenko, V.A. Antipin, A.V. Bobylev, and D.M. Markovich. Application of PIV to velocity measurements in a liquid film flowing down an inclined cylinder. *Experiments in Fluids*, 43:197–207, 2007. doi: [10.1007/s00348-007-0322-2](https://doi.org/10.1007/s00348-007-0322-2).
- [8] W. Aouad, J.R. Landel, S.B. Dalziel, J.F. Davidson, and D.I. Wilson. Particle image velocimetry and modelling of horizontal coherent liquid jets impinging on and draining down a vertical wall. *Experimental Thermal and Fluid Science*, 74:429–443, 2016. doi: [10.1016/j.expthermflusci.2015.12.010](https://doi.org/10.1016/j.expthermflusci.2015.12.010).
- [9] A.C. Ashwood, S.J. Vanden Hogen, M.A. Rodarte, C.R. Kopplin, D.J. Rodríguez, E.T. Hurlburt, and T.A. Shedd. A multiphase, micro-scale PIV measurement technique for liquid film velocity measurements in annular two-phase flow. *International Journal of Multiphase Flow*, 68:27–39, 2015. doi: [10.1016/j.ijmultiphaseflow.2014.09.003](https://doi.org/10.1016/j.ijmultiphaseflow.2014.09.003).
- [10] T. Takamasa and T. Hazuku. Measuring interfacial waves on film flowing down a vertical plate wall in the entry region using laser focus displacement meters. *International Journal of Heat and Mass Transfer*, 43(15):2807–2819, 2000. doi: [10.1016/S0017-9310\(99\)00335-X](https://doi.org/10.1016/S0017-9310(99)00335-X).
- [11] K. Moran, J. Inumaru, and M. Kawaji. Instantaneous hydrodynamics of a laminar wavy liquid film. *International Journal of Multiphase Flow*, 28(5):731–755, 2002. doi: [10.1016/S0301-9322\(02\)00006-X](https://doi.org/10.1016/S0301-9322(02)00006-X).
- [12] M. Tebbal and H. Mzad. An hydrodynamic study of a water jet dispersion beneath liquid sprayers. *Forschung im Ingenieurwesen*, 68(3):126–132, 2004. doi: [10.1007/s10010-003-0118-3](https://doi.org/10.1007/s10010-003-0118-3). (in German).
- [13] H. Mzad and M. Tebbal. Thermal diagnostics of highly heated surfaces using water-spray cooling. *Heat and Mass Transfer*, 45(3):287–295, 2009. doi: [10.1007/s00231-008-0431-3](https://doi.org/10.1007/s00231-008-0431-3).

-
- [14] E.S. Benilov, S.J. Chapman, J.B. McLeod, J.R. Ockendon, and V.S. Zubkov. On liquid films on an inclined plate. *Journal of Fluid Mechanics*, 663(25):53–69, 2010. doi: [10.1017/S002211201000337X](https://doi.org/10.1017/S002211201000337X).
- [15] X.G. Huang, Y.H. Yang, P. Hu, and K. Bao. Experimental study of water–air countercurrent flow characteristics in large scale rectangular channel. *Annals of Nuclear Energy*, 69:125–133, 2014. doi: [10.1016/j.anucene.2014.02.005](https://doi.org/10.1016/j.anucene.2014.02.005).
- [16] Y.Q. Yu and X. Cheng. Experimental study of water film flow on large vertical and inclined flat plate. *Progress in Nuclear Energy*, 77:176–186, 2014. doi: [10.1016/j.pnucene.2014.07.001](https://doi.org/10.1016/j.pnucene.2014.07.001).
- [17] H. Mzad and M. Elguerri. Simulation of twin overlapping sprays underneath hydraulic atomizers: influence of spray hydrodynamic parameters. *Atomization and Sprays*, 22(5):447–460, 2012. doi: [10.1615/AtomizSpr.2012006076](https://doi.org/10.1615/AtomizSpr.2012006076).
- [18] K. Choual, R. Benzeguir, and M. Tebbal. Experimental study of the dispersion beneath liquid sprayers in the intersection area of jets on a horizontal plate. *Mechanika*, 23(6):835–844, 2017. doi: [10.5755/j01.mech.23.6.17243](https://doi.org/10.5755/j01.mech.23.6.17243).
- [19] W-F. Du, Y-H. Lu, R-C. Zhao, L. Chang, and H-J. Chang. Film thickness of free falling water flow on a large-scale ellipsoidal surface. *Progress in Nuclear Energy*, 105:1–7, 2018. doi: [10.1016/j.pnucene.2017.12.007](https://doi.org/10.1016/j.pnucene.2017.12.007).
- [20] C.B. Tibiriçá, F.J. do Nascimento, and G. Ribatski. Film thickness measurement techniques applied to micro-scale two-phase flow systems. *Experimental Thermal and Fluid Science*, 34(4):463–473, 2010. doi: [10.1016/j.expthermflusci.2009.03.009](https://doi.org/10.1016/j.expthermflusci.2009.03.009).
- [21] H. Ouldrebai, E.K. Si-Ahmed, M. Hammoudi, J. Legrand, Y. Salhi, and J. Pruvost. A laser multi-reflection technique applied for liquid film flow measurements. *Experimental Techniques*, 43:213–223, 2019. doi: [10.1007/s40799-018-0279-5](https://doi.org/10.1007/s40799-018-0279-5).
- [22] J. Cai and X. Zhuo. Researches on hydrodynamics of liquid film flow on inclined plate using diffuse-interface method. *Heat and Mass Transfer*, 56:1889–1899, 2020. doi: [10.1007/s00231-020-02829-6](https://doi.org/10.1007/s00231-020-02829-6).
- [23] E.G Bratuta and M. Tebbal. Influence of the jet on the fluid dispersion. *IzvestiaVouzob, Métallurgie*, 12:108–111, 1983.
- [24] B. Patrick, B. Barber, and D. Brown. Practical aspects of the design, operation and performance of caster spray systems. *Revue de Métallurgie*, 98(4):383–390, 2001. doi: [10.1051/metal:2001192](https://doi.org/10.1051/metal:2001192).