

Integrated Access and Backhaul based 5G Connectivity for Rural Indian Sectors – Ending the Digital Divide

Ardhendu Shekhar Biswas, Sanjib Sil, Rabindranath Bera, and Monojit Mitra

Abstract—The world is heading towards deployment of 5G commercially by the year 2020. But providing broadband 5G connectivity to remote rural regions is a significant challenge. Fiber connectivity has attempted to penetrate rural regions but last mile connectivity is still a problem in many rural sectors due to improper land demarcation and hostile terrain. A scheme which is based on the Integrated Access and Backhaul (IAB) concept is proposed to provide last mile 5G connectivity to satisfy the broadband needs of rural subscribers. A wireless 5G downlink environment following 3GPP NR specifications with a significantly high throughput is simulated. The last mile link is provided through a 28GHz carrier from a proposed IAB node delivering a data throughput of 4.301 Gbps for single-user carrier aggregation and 5.733 Gbps for multi-user carrier aggregation which is quite promising for broadband service, like high-speed Internet and streaming video. The results presented in this work are observed to agree favourably with the results of other researchers in the field.

Keywords—Carrier aggregation (CA), component carrier (CC), 5G, New Radio (NR), Integrated Access and Backhaul (IAB)

I. INTRODUCTION

THE rural India lags behind the urban India in not just Internet penetration but also in Internet access due to poor quality of signals or networks. This hampers the concept of Digital India leading to the Digital divide. Digital India is a campaign launched by the Government of India in order to ensure the Government's services are made available to citizens electronically by improved online infrastructure and by increasing Internet connectivity. Providing internet connectivity to a remote Indian village home is a challenge. In this context, BharatNet and Reliance Jio GigaFiber are attempting to offer fiber connectivity to rural areas. But last-mile connectivity to remote village homes by fiber cable is not possible at present due to factors such as affordability considering the socioeconomic scenario in rural areas, as well

Ardhendu Shekhar Biswas is with Department of Electronics and Communication Engineering, Techno International New Town, Kolkata - 700156, India (email: a_s_biswas@yahoo.co.in).

Sanjib Sil is with Department of Electronics and Communication Engineering, Calcutta Institute of Engineering and Management, Kolkata -700040, India (email: sanjib_sil@hotmail.com)

Rabindranath Bera is with Department of Electronics Communication Engineering, Sikkim Manipal Institute of Technology, Sikkim, India (email: rbera50@gmail.com).

Monojit Mitra is with Department of Electronics and Telecommunication Engineering, IEST Shibpur, Howrah, India (email: monoji_m1@yahoo.co.in).

as issues in proper demarcation and survey of lands. At most, the fiber link can be available at some convenient place in the village, like the block development or gram panchayat office (GPO). The existing 4G network infrastructure is consequently unable to maintain the requisite quality of experience (QoE) for rural users, and in some cases potential users can receive no service at all. The fiber connectivity/link can be exploited as a potential solution to these problems.

With the addressing of IAB by '3GPP- Release 16' [1], a new deployment scenario, we envision and propose a scheme where a high data rate broadband signal available from the fiber end point can be transported to the remote end via narrow beam high bandwidth millimetre wave backhaul links. Basically, this scheme will have two or more IAB nodes fitted with antennas forming a backhaul link [2]. One IAB donor node will be at the fiber link end and the other IAB nodes will be at the remote end, near the villager's home, roof top or beyond as per requisite penetration. The IAB donor node will beam the 5G broadband signal toward the IAB node 1 at the remote location. The IAB node 1 will provide broadband service access to the villager's home with 5G-grade Quality-of-Service. Further the IAB node 1 can be utilized to extend the connectivity towards a third child IAB node 2 located deep inside the locality by onward signal transmission. A typical deployment scenario is shown in Figure 1. It is relevant to mention here that earlier the authors have worked on the simulation of a modified 4G link for last-mile connectivity [3] which paved the way to envision the above-proposed scheme.

In the present work the authors have partially realized the proposed scheme by establishing a 28 GHz backhaul link to support IAB communication. This link has been simulated and physically implemented for feasibility study for transport of broadband high speed data. In the simulation environment a 5G NR 28 GHz line of sight (LOS) downlink (considered as IAB backhaul link) is established where a 5G NR specified baseband signal is passed over the 28 GHz link and successfully demodulated. The simulation is carried by Keysight's 'Systemvue' software. In the physical realization a 28 GHz LOS link has been established and being tested for the transmission of 5G NR data. The results of the two realizations are thoroughly investigated and have been presented in this paper in subsequent sections.

The work done is briefly outlined as follows.



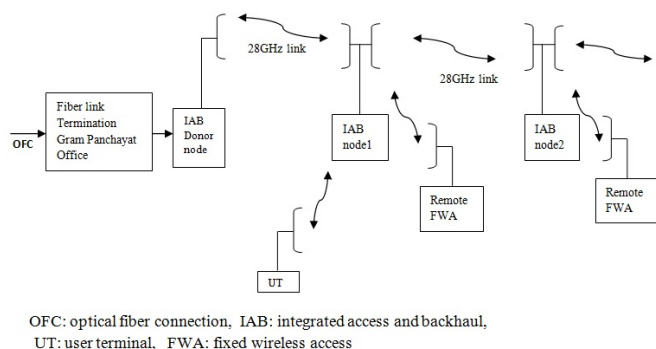

Fig. 1. Proposed Network Model for deployment of IAB based 5G broadband connectivity to remote village homes

- Establishment of 5G NR 28GHz link by simulation
- Carrier aggregation using four component carriers (CC) for single user case which achieves throughput of 4.301 Gbps
- Performance study of the simulation link for varying SNR using cluster delay line (CDL) channel model
- Carrier aggregation using four component carriers (CC) for multi user case which achieves throughput of 5.733 Gbps
- Physical implementation of 28GHz link to be used as a IAB backhaul to transport 5G signal.

The paper is organized in the following manner. Section 1 introduces the research problem and scenario investigated in this paper. In section 2 the recent research in the domain is reviewed, with specific context to 5G baseband signal processing and throughput enhancement. The proposed scheme of IAB based last mile connectivity is described in section 3. In section 4 the methodology of setting up and running the simulation in the simulation environment presented in this work is discussed. In section 5 the mathematical expressions used in the present work to represent the OFDM signals, sub-carrier signals, single-user and multi-user composite signals are shown. In section 6 the simulation of a 5G downlink signal with one component carrier (CC) is presented and explained. The maximum throughput obtained is then examined. In section 7 the simulation of single-user Carrier aggregation (CA) with four CCs is shown. In section 8 the performance of single-user CA with four CCs and varying SNR is discussed. The throughput is examined. In section 9 multi-user CA with four CCs is simulated and the results are presented. In section 10 the hardware realization of 28 GHz backhaul link is presented and discussed. Section 11 concludes the paper by illustrating the conclusions derived from the results achieved.

II. RELATED WORKS

CA is a leading mechanism to increase throughput and is widely adopted by a large number of scientists and system designers in the field of 5G wireless communications. A brilliant approach to mitigate challenges of dynamic carrier aggregation is proposed using an enhanced signalling mechanism for the 5G scenario in [4]. A scheme of wavelength division

multiplexing and frequency division multiplexing for dense small cells with intensity modulation and field modulation is proposed to support ubiquitous wireless access in [5]. Less than six percent error vector magnitude is achieved. A multi-stream carrier aggregation (MSCA) algorithm is proposed to maximize the bandwidth and minimize energy consumption in the context of a heterogeneous wireless 5G network for capacity enhancement [6]. A trade-off curve between energy minimization and capacity maximization is presented which shows big energy saving using MSCA. A method of joint relay selection and optimal power allocation in cognitive radio with carrier aggregation is investigated in [7] where simulation results show that the proposed scheme maximizes secondary user rate, constrained by primary user outage probability. CA can be used with a game-theory based algorithm for setting different power values for different component carriers for throughput enhancement in an energy-efficient manner [8]. CA with spectrally efficient frequency division multiplexing (SEFDM) for multiple component carriers has been used in test-bed based experiments to show that the proposed technique outperforms CA with orthogonal frequency division multiplexing (OFDM) [9]. Coordinated multipoint and carrier aggregation technique are applied in conjunction to increase availability of user equipment and single-path availability in heterogeneous 5G network in [10]. A scheme of adaptive pilot spacing and power is proposed for OFDM systems with CA in [11] and it shows significant throughput performance gain in comparison to LTE systems. During CA, CC selection is very important to achieve the goal of throughput enhancement with a suitable bit error rate (BER). A method of CC selection following the neural network approach is suggested in [12] and simulation shows enhanced throughput performance. Field experiments are also going on in different parts of the globe. CA with four CCs and 4x4 multiple-input and multiple-output (MIMO) multiplexing is demonstrated in [13] at the carrier frequency band of 15 GHz using a bandwidth of 400 MHz where the experimental results achieved a throughput of 3 Gbps in the outdoor environment. A non-contiguous CA technique is suggested in [14] using joint DFT spread OFDM signal and simulation results show 1.5 dB PAPR reduction without hampering link-level BER performance. A filtered OFDM signal based carrier aggregation of five CCs each of 200 MHz is suggested over a 6 GHz wireless link and 20 Km fiber link in [15] and simulation results are shown to achieve a good throughput performance. A joint resource management scheme of resource allocation, CC selection and link adaptation for CA is proposed with low complexity computation in [16], with the proposed technique showing a good throughput performance.

III. PROPOSED NETWORK MODEL DEPLOYMENT SCENARIO FOR LAST MILE CONNECTIVITY

A novel scheme proposed for last mile connectivity has previously been shown in figure 1. The proposed scheme is based on the concept of IAB and the objective is to provide high throughput connectivity to the last mile. The optical fiber cable is terminated at the Gram Panchayat Office (GPO) as indicated in Figure 1. There will be an IAB donor node at the

GPO which will beam a 28 GHz signal carrying 5G NR data to the next remote IAB node 1. The IAB nodes can be installed over roof tops or fitted on poles near homes which need to be connected to the communication network. These IAB nodes are basically 5G NR transceivers and provide both access and backhaul services. The IAB node 1 can further extend or relay the 28 GHz signal towards IAB node 2, serving more remote user terminals (UTs) or fixed wireless access points. Consequently, 5G NR signal reaches remote users through successive 28 GHz 5G links. In a similar fashion, other more distant users can be connected with a number of successive 5G links via IAB node 2 and more.

IV. METHODOLOGY

The 28 GHz 5G link is the key element of the above mentioned scheme as observed in section 3. The scheme proposed in the work aims to explore and utilize the high bandwidth (BW) capacity of the 28 GHz signal where available BW is almost 2.5 GHz. Our proposed scheme allows for efficient utilization of large bandwidth (more than 1 GHz) to achieve high throughput.

In this work, we have simulated a 28 GHz, 5G NR downlink environment. Here, CA technique is used to increase bandwidth (BW) and effectuate the corresponding enhancement of throughput. We have used CA for two different implementation cases. In the first case, a single user's data is sent over a carrier aggregated band and in the second, multiple users data is placed onto different carriers and aggregated. A schematic diagram is shown in Figure 2 and 3. In Figure 2, carrier aggregation is illustrated for single user case. The single user data are coming out from data port 1, 2, 3 and 4 of the 5G New Radio (NR) source and the sync support block (SSB) signals from the SSB port of the 5G NR source. The SSB signal from SSB port is added to all the data signals of four data ports. These four signals are then carrier aggregated with four component carriers from the oscillators 1, 2, 3 and 4.

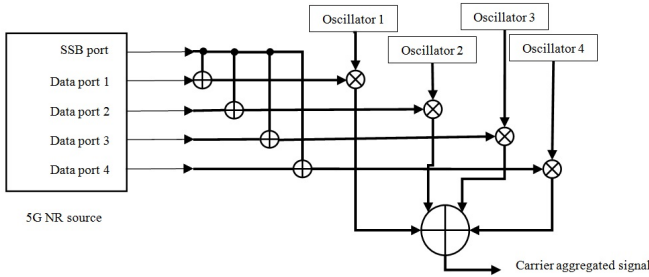

Fig. 2. Block schematic diagram of Single-user carrier aggregation

In figure 3, a carrier aggregation scenario with four different users is illustrated. Here, four 5G NR sources are used for four users. One data signal and one SSB signal are obtained from each of the sources. The data signals and SSB signals are added for all the sources to form four combined signals and then finally the four signals are carrier aggregated. To be noted here is that for using four 5G NR sources, the computation time in the simulation will be greater here in comparison to the previous case of single 5G NR source.

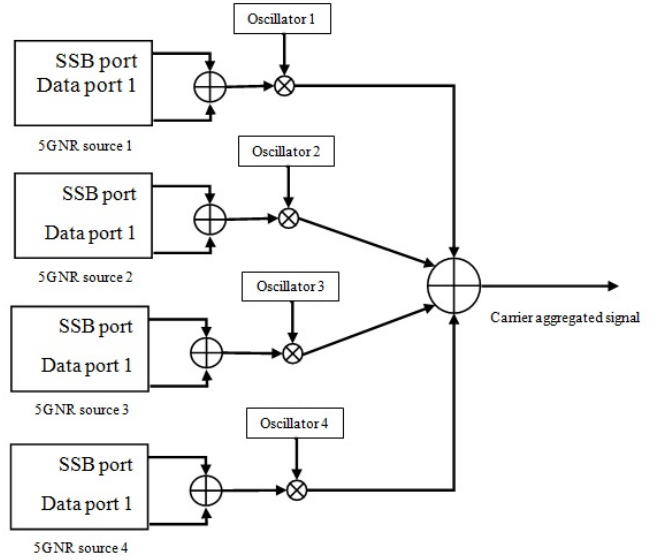

Fig. 3. Block schematic diagram of Multi-user carrier aggregation

According to 3GPP 5G NR standards the maximum allowable BW in one CC is 400 MHz. In our simulation we have utilized the complete BW and maximum possible number of resource blocks (RB) in one CC as specified. This is to achieve maximum throughput so that the throughput experienced by each user can be maximized to the desired extent.

The flow of the simulation work is as follows: (i) First by using one CC we performed the execution of 5G NR downlink model and obtained the throughput. (ii) Then we executed the model corresponding to the case of single user utilizing four CC which is also known as single user CA. We obtained the resultant throughput corresponding to this case. (iii) This model was further tested to gauge its performance with respect to varying SNR and the corresponding throughput and BER were obtained by us. (iv) Finally, the multi user case with four different users and four CCs was executed and the corresponding throughput was measured by us.

V. MATHEMATICAL MODEL OF SIGNALS

The time domain signal $s_l^p(t)$ [17] on the antenna port p for a specific subcarrier spacing configuration and the l th OFDM symbol in a frame/ sub-frame for any physical channel is defined by

$$s_l^p(t) = \sum_{k=0}^{N_G N_{SC} - 1} a_{k,l}^p e^{j2\pi(k+k_0 - N_G N_{SC}/2)\Delta f(t - t_{CP} - t_{s,l})} \quad (1)$$

where N_G is the grid size, N_{SC} is the number of subcarrier per RB, $a_{k,l}^p$ is the complex-valued physical resource, k is the subcarrier index, k_0 is the lowest numbered subcarrier for a specific numerology, Δf is subcarrier spacing (SCS), t_{CP} is the time elapsed for cyclic prefix and $t_{s,l}$ is the start time of the l th OFDM symbol.

For implementation of Equation 1 in simulation, the signal must be sampled at a rate $f_s = N\Delta f$ which is a multiple

of SCS, where N is an integer. Hence putting $t = nT_s$ and $\Delta f = f_s/N = 1/(NT_s)$. Equation 1 is simplified to

$$s_i^p(t) = \sum_{k=0}^{N_G N_{SC} - 1} a_{k,l}^p e^{j2\pi(k+k_0 - N_G N_{SC}/2)(nT_s - t_{CP} - t_{s,i})/NT_s} \quad (2)$$

Where $T_s = 1/f_s$, n is an integer.

Similar types of signals can be used for both the data block and SSB for transmission of signals from the 5G NR source. The signal of the form in Equation 2 can be generated in IFFT based 5G NR source. Four data ports and one sync port are used here for single-user carrier aggregation. Let us consider $s_i^{p1}(n)$, $s_i^{p2}(n)$, $s_i^{p3}(n)$, $s_i^{p4}(n)$ are the signals from the four data ports and $g_i^{p5}(n)$ is the signal from the SSB port, where $p1$, $p2$, $p3$, $p4$ are data ports and $p5$ is the sync port from the same NR source. Then these signals are taken into four radio frequency (RF) chain and are given by

$$d_i^{r1}(n) = Re\{[s_i^{p1}(n) + g_i^{p5}(n)]e^{j2\pi f_1(nT_s - t_{CP} - t_{s,i})}\} \quad (3)$$

$$d_i^{r2}(n) = Re\{[s_i^{p2}(n) + g_i^{p5}(n)]e^{j2\pi f_2(nT_s - t_{CP} - t_{s,i})}\} \quad (4)$$

$$d_i^{r3}(n) = Re\{[s_i^{p3}(n) + g_i^{p5}(n)]e^{j2\pi f_3(nT_s - t_{CP} - t_{s,i})}\} \quad (5)$$

$$d_i^{r4}(n) = Re\{[s_i^{p4}(n) + g_i^{p5}(n)]e^{j2\pi f_4(nT_s - t_{CP} - t_{s,i})}\} \quad (6)$$

Here $r1$, $r2$, $r3$, and $r4$ represent four RF chains for carrier aggregation. $f1$, $f2$, $f3$, and $f4$ are four different component carrier frequencies. Then the carrier aggregated signal for a single user is given by

$$d_i^{SU}(n) = d_i^{r1}(n) + d_i^{r2}(n) + d_i^{r3}(n) + d_i^{r4}(n) \quad (7)$$

For multiuser carrier aggregation, the signals for the four RF chains are given by

$$d_i^{r11}(n) = Re\{[s_i^{p11}(n) + g_i^{p15}(n)]e^{j2\pi f_1(nT_s - t_{CP} - t_{s,i})}\} \quad (8)$$

$$d_i^{r22}(n) = Re\{[s_i^{p21}(n) + g_i^{p25}(n)]e^{j2\pi f_2(nT_s - t_{CP} - t_{s,i})}\} \quad (9)$$

$$d_i^{r33}(n) = Re\{[s_i^{p31}(n) + g_i^{p35}(n)]e^{j2\pi f_3(nT_s - t_{CP} - t_{s,i})}\} \quad (10)$$

$$d_i^{r44}(n) = Re\{[s_i^{p41}(n) + g_i^{p45}(n)]e^{j2\pi f_4(nT_s - t_{CP} - t_{s,i})}\} \quad (11)$$

Here ports $p11$ and $p15$ are taken from the same 5G NR source but $p11$, $p21$, $p31$, $p41$ are taken from four different sources i.e., signals generated in Equation 8, 9, 10, 11 are from four different sources or user. Then the final multiuser carrier aggregated signal is given by

$$d_i^{MU}(n) = d_i^{r11}(n) + d_i^{r22}(n) + d_i^{r33}(n) + d_i^{r44}(n) \quad (12)$$

TABLE I
SIMULATION PARAMETERS TO ACHIEVE MAXIMUM THROUGHPUT BY ONE CC

Parameters	Value
Numerology	3
Number of RBs in one component carrier	264
Number of BWPs	1
The starting RB index of resource blocks allocated to BWP in the whole bandwidth based on SCS of 120KHz (RB Offset)	24
Number of PRB in BWP based on different SCS of different numerology	240
Number of OFDM symbol	14
Transport block size for each slot	225000
Code rate	0.887879
Modulation orders in each slot (2:QPSK, 4:16QAM, 6:64QAM, 8:256QAM)	8:256 QAM
Number of slots allocated	80
Carrier Frequency	28 GHz

VI. THROUGHPUT ACHIEVEMENT BY ONE COMPONENT CARRIER (CC)

In order to reach the goal of achieving higher throughput, a 5G NR downlink connection is established in the Keysight SystemVue simulation environment. At the first step maximum possible throughput in one BWP is generated through simulation. The parameters adjusted are shown in Table I which are as per allowable bandwidth parameters referred in [18].

All specifications are maintained according to 3GPP standards. Numerology is set at 3 which signifies a subcarrier spacing (SCS) of 120 kHz to exploit very high bandwidth availability at 28 GHz carrier. Selection of this high SCS of 120 KHz ensures less interference between subcarriers. It also reduces slot duration and hence in the same subframe it allows a greater number of slots thereby increasing data capacity and throughput. The total number of RBs in one CC is selected as 264 which is the maximum as per 3GPP. During data allocation in the physical downlink shared channel (PDSCH) an offset of 24 RBs is taken to accommodate SSB. It is necessary to avoid overlapping of SSB and data block in the frequency domain for successful decoding of sync data at the receiver. The number of RBs for data is then 240. The number of OFDM symbols is 14 in which 13 symbols are used for data/sync block allocation and 1 symbol for offset. Transport block size (TBS) is 225000 at a code rate of 0.887879 depending on the total number of RBs allocated for data. TBS and code rate are also dependent on the depth of modulation, set at 256 QAM which is maximum according to 3GPP specification. At the SCS of 120 kHz (numerology = 3), there are 80 available slots per frame in a frame of 10 milliseconds. It is indeed a necessity to send data over all the slots to increase throughput and hence the number of slots allocated is 80. Carrier frequency is maintained at 28 GHz to exploit the huge bandwidth at this frequency. The BW consumption for this transmission is found to be 379.9 MHz which is measured from the simulated output spectrum

shown in Figure 4. In this simulation AWGN channel with zero noise power is considered between the downlink transmitter and receiver. This is to determine how much data can be accommodated in one CC and estimate the maximum possible throughput. The simulation results show that the throughput achieved is 1.717 Gbps as mentioned in Table II.

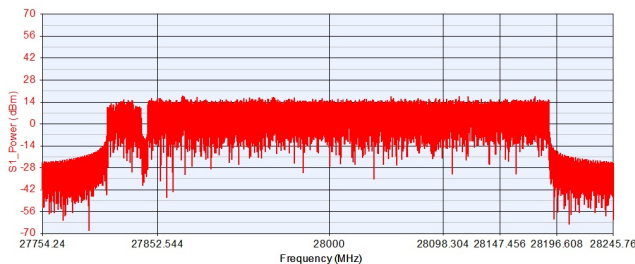

Fig. 4. Bandwidth of 28 GHz downlink signal delivering throughput of 1.717 Gbps

TABLE II
SUMMARY OF THROUGHPUT ACHIEVEMENT BY ONE CC

No. of CC	Bandwidth	Gap between SSB and Data block	Transport Block Size (TBS)	Throughput
1	379.9 MHz	6.1 MHz	225000	1.717 Gbps

VII. SINGLE USER CARRIER AGGREGATION

This scheme is simulated according to Figure 2 and as described in the methodology. In this scheme contiguous carrier aggregation of four component carriers around 28 GHz frequency are put together for single user. Here data from a source will be modulated according to 5G New Radio standards on different branches using different ports of the 5G NR downlink (DL) source in the Keysight SystemVue simulation environment. For this setup, numerology, RBs in one CC, number of BWPs, RB offset, allocated RBs, OFDM symbols, modulation order, slots allocated and carrier frequency are the same as in the previous simulation given in Table I and reiterated in Table III.

The number of RF chains is four for aggregating four contiguous CCs. There are five antenna ports from the 5G NR DL source. Modulated data blocks come out from four ports and the SSB from the other antenna port. As shown in the spectrum in figure 5 both SSB and data blocks are sent in all the RF chains for successful physical broadcast channel (PBCH) decoding. Per carrier BW range selected is 400 MHz which is the maximum range allowable in one CC. The actual overall BW will depend on the number of RBs chosen and band gap maintained between two successive CC and should be measured from the simulated spectrum. TBS and code rates are different from the previous simulation because now the number of CC is increased to 4. Apparently, TBS is four times that of previous simulation and code rate is the same. Practically they are different where TBS is set at 600000 and the code rate is 0.59188 to maintain a comfortable bit error rate

TABLE III
SIMULATION PARAMETERS TO ACHIEVE MAXIMUM THROUGHPUT BY FOUR CC FOR SINGLE USER CA

Parameters	Value
Numerology	3
Number of RBs in one component carrier	264
Number of BWPs	1
The starting RB index of resource blocks allocated to BWP in the whole bandwidth based on SCS of 120KHz (RB Offset)	24
Number of PRB in BWP based on different SCS of different numerology	240
Number of OFDM symbol	14
Transport block size for each slot	600000
Code rate	0.59188
Modulation orders in each slot (2:QPSK, 4:16QAM, 6:64QAM, 8:256QAM)	8:256 QAM
Number of slots allocated	80
Carrier Frequency	28 GHz
Component carriers	27.4 GHz, 27.8 GHz, 28.2 GHz, 28.6 GHz
Bandgap between two successive component carriers	19.893 MHz
Number of RF chain	4
Number of antenna ports	5
SNR	40 dB

(BER). Normal cyclic prefix is used in this case. The signal is sent over an AWGN channel with constant noise density.

The simulation results show that the throughput achieved is 4.301 Gbps as mentioned in Table IV and the simulated spectrum is shown in Figure 5.

TABLE IV
SUMMARY OF THROUGHPUT ACHIEVEMENT BY FOUR CC FOR SINGLE USER CA

No. of CC	Bandwidth	Gap between SSB and Data block	Transport Block Size (TBS)	Throughput
4	1580.12 MHz	6.1 MHz	600000	4.301 Gbps

It is very important to set the simulation sampling rate. The sampling rate depends on the transmitted signal BW and oversampling. The basic technology in 5G NR is based on orthogonal frequency division multiplexing (OFDM) and in sampled OFDM it is necessary to maintain that sampling rate is multiple of SCS and multiplicity is so chosen that it satisfies sampling theorem. During carrier aggregation, BW is four-fold and oversampling is carried out accordingly.

VIII. PERFORMANCE OF SINGLE USER CARRIER AGGREGATION WITH FOUR CC FOR VARYING SNR

A clustered delay line (CDL) channel model [19] is used for this simulation and the channel parameters are shown in Table V. The SNR is varied as to emulate the real-life field conditions observed for rural regions. Simulation results are

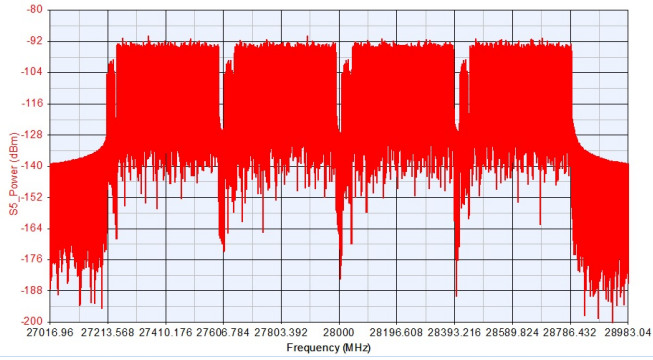

Fig. 5. Bandwidth of downlink signal around 28 GHz with four CCs delivering throughput of 4.301 Gbps

shown in Table VI and the graphs in Figures 6, 7, 8, and 9 respectively.

TABLE V
SIMULATION PARAMETERS FOR CDL CHANNEL MODELLING FOR SINGLE USER CA

Parameters	Value
Environment	CDL(Cluster Delay Line) model
LOS Theta (deg)	90
LOS Phi (deg)	0
UT (user terminal) Speed (km/hr)	0
BS (base station) Height (m)	10
UT Height (m)	1.5
Distance 2D (m)	50
Propagation Condition	LOS
Path Loss (dB)	21.36
Penetration Loss (dB)	0
Shadow Fading (dB)	0

TABLE VI
PERFORMANCE SUMMARY OF SINGLE USER CARRIER AGGREGATION WITH FOUR CC FOR VARYING SNR

Bandwidth = 1580.12 MHz, Transport Block Size = 600000			
SNR	Signal Power (dBm)	Throughput	BER
40	-21.234	4.301Gbps	5.465e-9
35	-26.234	4.301Gbps	49.18e-9
30	-31.234	4.301Gbps	10.09e-6
25	-36.234	4.301Gbps	0.043
20	-41.234	4.301Gbps	0.01
10	-51.234	4.301Gbps	0.069
8	-53.234	0	0.089
5	-56.234	0	0.28

In Figure 6 and 7 it is seen that BER decreases with increase in SNR and signal power. In Figure 6 it is to be noted that almost above 25 dB SNR level BER is decreasing at a faster rate. It is because the modulation order used here (256 QAM) is very high. For this reason, at lower SNRs very high number of bits are lost due to improper detection of large number of symbols. This leads to very high BER at lower SNRs, that

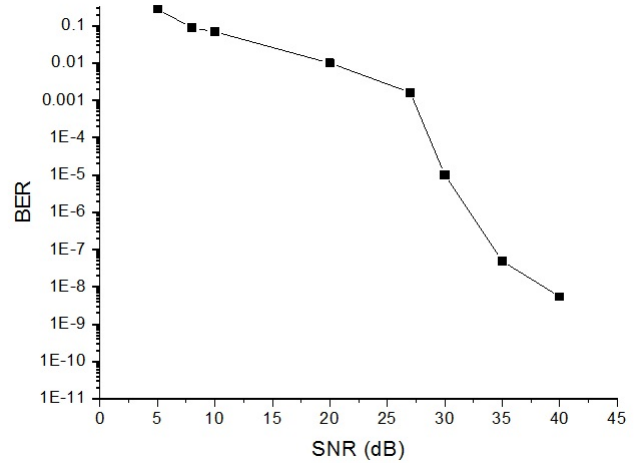

Fig. 6. Variation of SNR with BER

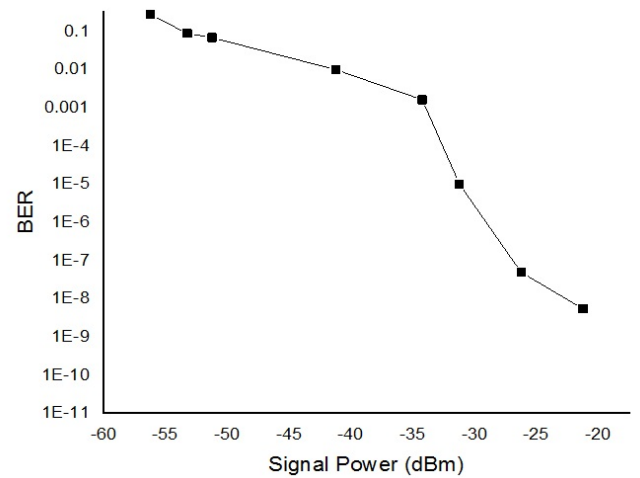

Fig. 7. Variation of Signal Power with BER

is, slow rate of BER decrease with increasing SNR below 25 dB. At higher values of SNRs, more numbers of symbols are properly detected and it gives rise to large number of error free detection of bits. For one correct detection of a symbol leads to 8 correct bits i.e., effect on BER should be 8 times greater. This is the reason why BER is found to fall very fast at higher SNR levels with more and more correct detection of the symbols.

As shown in Figure 8, there is abrupt change in throughput near 10 dB SNR level. Apparently, it seems that this system achieves the maximum throughput almost above 10 dB and the system is performing very well in terms of throughput at such low SNR. In fact, in SystemVue simulation environment, the throughput measurement is carried out by considering the transport block size (TBS) in a slot and results of cyclic redundancy check (CRC) per sub-frame. Such measurement provides average throughput over all the slots.

At SNR less than 10 dB, the CRC results generated for each sub-frame is found to be '0' which indicates the presence of an error in the sub frame and considers zero contribution of

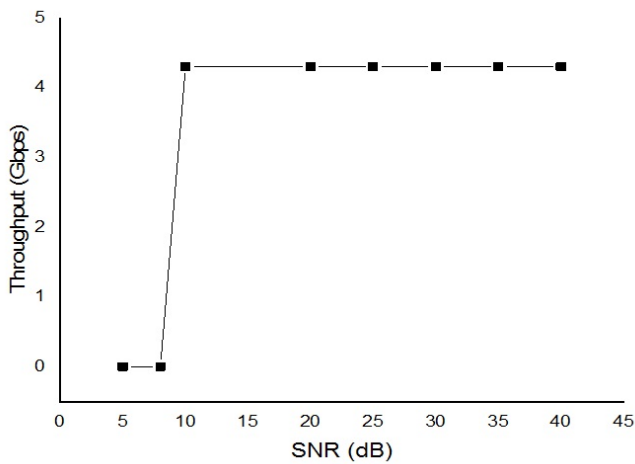

Fig. 8. SNR vs Throughput

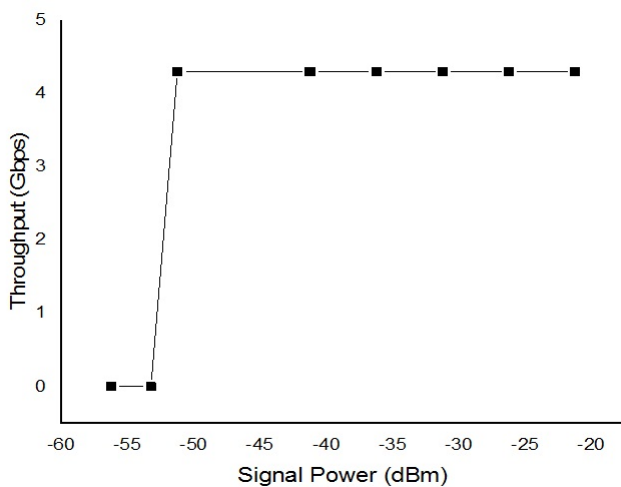

Fig. 9. Signal Power vs Throughput

the sub frame for throughput measurement. On the other hand, for SNR levels greater than 10 dB the CRC results generated are found to be '1' which indicates that no error has taken place in the sub frame and the corresponding measurement exhibits the maximum throughput of the slot. This mechanism of throughput measurement is repeated for all the slots. Hence this is the reason for the sharp change in the variation of throughput with SNR that can be observed in Figure 8. However above 10 dB SNR the measured throughput achieved is at maximum level but it does not indicate the absence of bit error. To find the bit error rate at a particular SNR, the SNR versus BER plot in Figure 6 has to be considered.

From the above discussions, it can be inferred from Figures 8 and 6, that SNR values for successful communication should simultaneously correspond to the area of the curve of maximum throughput and also small BER values. It can be seen that at SNR = 40, the BER is 5.465×10^{-9} with a throughput of 4.301 Gbps which is quite encouraging. Further, it can be observed from Table VI that the throughput is constant upto SNR = 10 dB and signal power = -51.234 dBm respectively.

There is hence a possibility that with a proper channel coding technique a better BER can be achieved at a reduced SNR and signal power level.

There is another very important observation in the spectrum shown in Figure 5. The gap band between two successive CC is 19.893 MHz as mentioned in Table III and the gap band between SSB block and data block is 6.1 MHz as given in Table IV. The gap of 19.893 MHz is chosen deliberately to avoid interference between two successive component carriers and the gap of 6.1 MHz is taken to eliminate the interference between SSB and data block. Since a high bandwidth of about 2.5 GHz is available for 28 GHz carrier it is not difficult to afford such high band gaps.

Consequently, such high band gaps of about 20 MHz and 6 MHz are therefore not exploited in our proposed system. The utility of such large band gaps however needs to be explored, to derive maximum benefit from them. Exploitation of these band gaps can therefore be implemented for some other applications. Dynamic spectrum sharing technology may be a useful way of utilizing these band gaps for achieving full duplex communication in the same bandwidth.

IX. MULTI-USER CARRIER AGGREGATION

This scheme is simulated as depicted in Figure 3 and as illustrated in the methodology. In this scheme, 4 CCs are used for CA but for four different users i.e., carrier aggregation for multiple users. The optimized parameters are given in Table VII. The CC frequencies are the same as used in Table III single user case and again it is contiguous carrier aggregation. The parameters are the same as in the single-user case except TBS, code rate, number of RF chain for each user, number of antenna port for each user and SNR. TBS, in this case, is 225000 which is apparently small in comparison to the previous case but it is for only one user. Here four different NR downlink (DL) sources are used and effectively the TBS is $225000 \times 4 = 900000$. The code rate is elevated in this case to 0.887879, in comparison to the corresponding single-user case. It is found during simulation that a higher code rate can be used for multiuser to achieve comfortable BER. The number of RF chains is 1 but it is for one DL source. Since there are 4 sources effectively the number of RF chains is four for 4 CCs. Each of the 5G NR DL sources has two antenna ports, one for data and another for sync support block. Interestingly the SNR is maintained at a higher value of 50 dB to have moderate BER performance.

A clustered delay line (CDL) channel model [19] is adopted for simulation. The CDL channel model parameters are given in Table VIII. Line of sight (LOS) communication is established at a 2D distance of 50 meters. The base station (BS) height is 10 meters and the user terminal (UT) height is 1.5 meter and UT is stationary i.e., UT speed is 0 km/hr. LOS theta and phi are 90 degrees and 0 degrees respectively.

Simulation results are shown in Table IX. The BER performance at 40 dB of SNR is measured. The data throughput achieved in this simulation for multi-user CA is 5.733 Gbps which is mentioned in Table IX and the corresponding spectrum is shown in Figure 10.

TABLE VII
SIMULATION PARAMETERS TO ACHIEVE MAXIMUM THROUGHPUT BY
FOUR CC FOR FOUR MULTI-USER CA

Parameters	Value
Numerology	3
Number of RBs in one component carrier	264
Number of BWPs	1
The starting RB index of resource blocks allocated to BWP in the whole bandwidth based on SCS of 120KHz (RB Offset)	24
Number of PRB in BWP based on different SCS of different numerology	240
Number of OFDM symbol	14
Transport block size for each slot	225000
Code rate	0.887879
Modulation orders in each slot (2:QPSK, 4:16QAM, 6:64QAM, 8:256QAM)	8:256 QAM
Number of slots allocated	80
Carrier Frequency	28 GHz
Component carriers	27.4 GHz, 27.8 GHz, 28.2 GHz, 28.6 GHz
Band gap between two successive component carriers	20 MHz
Number of RF chain for each user or NR source	1
Number of antenna ports for each user or NR source	2
SNR	40 dB

TABLE VIII
CDL CHANNEL MODEL PARAMETERS FOR MULTI-USER CA

Parameters	Value
Environment	CDL(Cluster Delay Line) model
LOS Theta (deg)	90
LOS Phi (deg)	0
UT (user terminal) Speed (km/hr)	0
BS (base station) Height (m)	10
UT Height (m)	1.5
Distance 2D (m)	50
Propagation Condition	LOS
Path Loss (dB)	21.36
Penetration Loss (dB)	0
Shadow Fading (dB)	0

X. HARDWARE REALIZATION OF 28 GHZ BACKHAUL LINK

For hardware realization, two 28 GHz full outdoor radio units with antenna of SAF Tehnika (model Integra-GS) are used to examine the feasibility of a backhaul link. There is a 0.3-meter (1 foot) dish antenna fitted to each of the radio units. The two radio units are set at a distance of 50 meter with respect to each other for LOS communication. The bandwidth chosen is 60 MHz, modulation profile is 64 QAM, exact transmission and reception frequency is 28780.50 MHz and vertical polarization is maintained. The received signal sensitivity of the radio is -80 dBm. Weather condition is almost

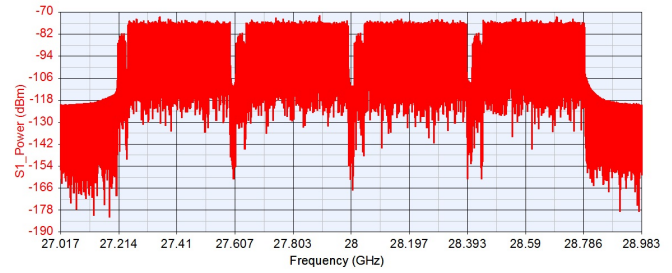

Fig. 10. Bandwidth of downlink signal around 28 GHz with four CCs delivering throughput of 5.733 Gbps

TABLE IX
SUMMARY OF THROUGHPUT ACHIEVEMENT BY FOUR CC FOR
MULTI-USER CA

Bandwidth =1580 MHz, Transport Block Size =225000×4 = 900000			
SNR	Signal Power (dBm)	Throughput	BER
40	-21.234	5.733 Gbps	52.65e-9

cloudy. Mean square error (MSE) and bit error rate (BER) are measured with varying received signal power. The results are shown in Figure 11.

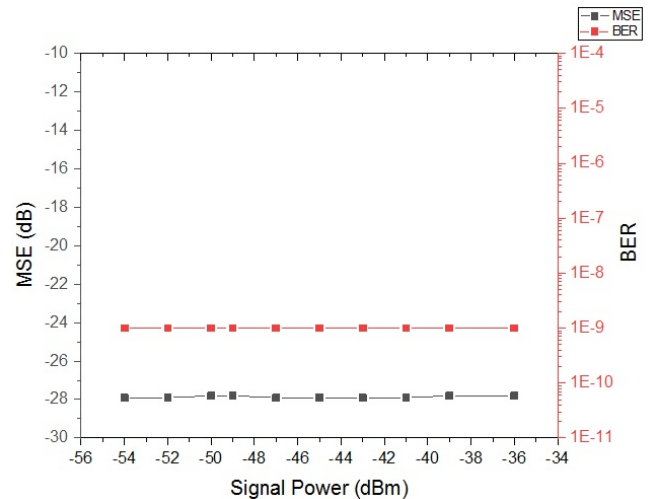

Fig. 11. Variation of Mean Square Error (MSE) and BER with Signal Power

Figure 12 depicts the received flat top spectrum at 28.7805 GHz with a Rx level at -52 dBm. The vertical scale is 10 dB per division with the link performance of more than 40 dB SNR. It provides a very high performance at data reception with negligible MSE and an extremely low BER performance.

A simulation model will be fruitful and successful if it can be implemented efficiently in reality with available hardware. This simulation work is using a 28 GHz link. In both the cases of single user and multiple user carrier aggregated 5G NR modulated signals are sent over a 28 GHz carrier and its performance is evaluated. The simulation results, BER and throughput performance as shown in Figures 6, 7, 8, 9 and Table VI are measured for the received signal power variation of almost from -55 dBm to -20 dBm. It is found that BER is

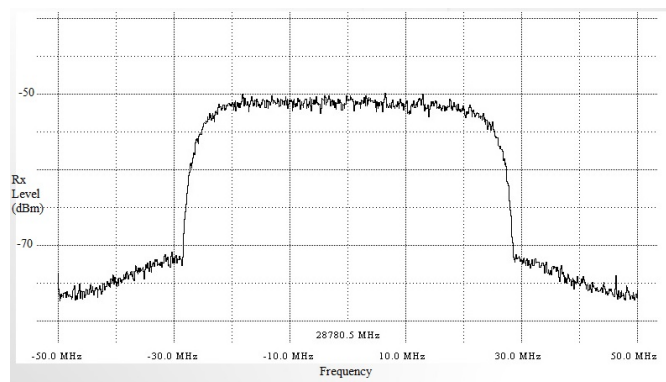

Fig. 12. Spectrum of 28 GHz signal

achieving around 10^{-6} almost at the level of -30 dBm received signal power level. On the other hand, in the physical link MSE and BER are measured for the received signal power variation almost in the range of -54 dBm to -36 dBm. MSE is prevailing almost in the level of -28 dB and BER is showing at the level of 10^{-9} . Interestingly, at -36 dBm signal level BER is prevailing at 10^{-9} and it is very much expected to maintain this BER performance at higher signal power level of -20 dBm and more which is in accordance with the simulation result. Hence it will be a judicious decision to use our simulation model for practical implementation. Definitely it is going to perform very efficiently in future field experiments with our simulation model. So, the authors are claiming their novelty for their proposed IAB based scheme and the partial implementation of the same in terms of millimetre wave 28 GHz backhaul link implementation and feasibility of the link which can transport high speed data to the last mile.

XI. CONCLUSION

With the objective of 5G broadband last-mile connectivity in rural areas, the authors are successful for partial implementation of the proposed IAB based scheme. In support of a high speed broadband backhaul link they have simulated a millimetre wave link of frequency 28 GHz. By simulation they have realized a data throughput of 4.301 Gbps for single-user CA and 5.733 Gbps for multi-user CA which is quite promising for high-speed Internet and streaming video. Further they have also established a physical 28 GHz millimeter wave wireless link that supports the basic data rate of internet exploiting a 60 MHz bandwidth for the feasibility study of last mile connectivity.

Thus, the vision and possibility of 5G broadband last-mile connectivity can be felt to achieve.

REFERENCES

- [1] 3GPP TR 21.916V0.5.0(2020-07), Summary of Rel-16 Work Items
- [2] Henrik Ronkainen, Jonas Edstam, Anders Ericsson, Christer Östberg, "Integrated access and backhaul – a new type of wireless backhaul in 5G", *Ericsson Technology Review* June 23, 2020. ISSN 0014-0171 284 23-3346 — Uen.
- [3] Biswas, A. S., Sil, S., Bera, R., and Mitra, M., "5G Based Broadband Last Mile Connectivity for Rural Sectors", International Conference on Emerging Technologies for Sustainable Development (ICETSD'19) Proceedings, GCELT Kolkata, 2019.
- [4] Vidhya R and Karthik P, "Dynamic Carrier Aggregation in 5G network scenario," 2015 International Conference on Computing and Network Communications (CoCoNet), Trivandrum, 2015, pp. 936-940, <https://doi.org/10.1109/CoCoNet.2015.7411303>.
- [5] M. Xu et al., "Bidirectional fiber-wireless access technology for 5G mobile spectral aggregation and cell densification," in *IEEE/OSA Journal of Optical Communications and Networking*, vol. 8, no. 12, pp. B104-B110, December 2016, <https://doi.org/10.1364/JOCN.8.00B104>.
- [6] E. Chavarria-Reyes, I. F. Akyildiz and E. Fadel, "Energy-Efficient Multi-Stream Carrier Aggregation for Heterogeneous Networks in 5G Wireless Systems," in *IEEE Transactions on Wireless Communications*, vol. 15, no. 11, pp. 7432-7443, Nov. 2016, <https://doi.org/10.1109/TWC.2016.2602336>.
- [7] P. D. Diamantoulakis, K. N. Pappi, S. Muhaidat, G. K. Karagiannidis and T. Khattab, "Carrier Aggregation for Cooperative Cognitive Radio Networks," in *IEEE Transactions on Vehicular Technology*, vol. 66, no. 7, pp. 5904-5918, July 2017, <https://doi.org/10.1109/TVT.2016.2635112>.
- [8] Z. Limani Fazliu, C. Chiasserini, G. M. Dell'Aera and E. Hamiti, "Distributed Downlink Power Control for Dense Networks With Carrier Aggregation," in *IEEE Transactions on Wireless Communications*, vol. 16, no. 11, pp. 7052-7065, Nov. 2017, <https://doi.org/10.1109/TWC.2017.2737998>.
- [9] T. Xu and I. Darwazeh, "Transmission Experiment of Bandwidth Compressed Carrier Aggregation in a Realistic Fading Channel," in *IEEE Transactions on Vehicular Technology*, vol. 66, no. 5, pp. 4087-4097, May 2017, <https://doi.org/10.1109/TVT.2016.2607523>.
- [10] J. Jia, Y. Deng, J. Chen, A. Aghvami and A. Nallanathan, "Availability Analysis and Optimization in CoMP and CA-enabled HetNets," in *IEEE Transactions on Communications*, vol. 65, no. 6, pp. 2438-2450, June 2017, <https://doi.org/10.1109/TCOMM.2017.2679747>.
- [11] R. M. Rao, V. Marojevic and J. H. Reed, "Adaptive Pilot Patterns for CA-OFDM Systems in Nonstationary Wireless Channels," in *IEEE Transactions on Vehicular Technology*, vol. 67, no. 2, pp. 1231-1244, Feb. 2018, <https://doi.org/10.1109/TVT.2017.2751548>.
- [12] R. Khdhir, B. Cousin, K. Mnif and K. Ben Ali, "Neural network approach for component carrier selection in 4G/5G networks," 2018 Fifth International Conference on Software Defined Systems (SDS), Barcelona, 2018, pp. 112-117, <https://doi.org/10.1109/SDS.2018.8370431>.
- [13] K. Tateishi et al., "Field experiments on 5G radio access using 15-GHz band in outdoor small cell environment," 2015 IEEE 26th Annual International Symposium on Personal, Indoor, and Mobile Radio Communications (PIMRC), Hong Kong, 2015, pp. 851-855, <https://doi.org/10.1109/PIMRC.2015.7343416>.
- [14] Z. Shi and Y. Wang, "Joint DFT-s-OFDM scheme for non-contiguous carriers transmission," 2017 IEEE/CIC International Conference on Communications in China (ICCC), Qingdao, 2017, pp. 1-6, <https://doi.org/10.1109/ICCCChina.2017.8330481>.
- [15] M. Bi, W. Jia, L. Li, X. Miao and W. Hu, "Investigation of F-OFDM in 5G fronthaul networks for seamless carrier-aggregation and asynchronous transmission," 2017 Optical Fiber Communications Conference and Exhibition (OFC), Los Angeles, CA, 2017, pp. 1-3.
- [16] S. Rostami, K. Arshad and P. Rapajic, "A joint resource allocation and link adaptation algorithm with carrier aggregation for 5G LTE-Advanced network," 2015 22nd International Conference on Telecommunications (ICT), Sydney, NSW, 2015, pp. 102-106, <https://doi.org/10.1109/ICT.2015.7124665>.
- [17] 3GPP TS 38.211 version 15.3.0 Release 15, 2018-10, Physical channels and modulation.
- [18] 3GPP TS 38.104 version 15.2.0 Release 15, 2018-07, Base Station (BS) radio transmission and reception.
- [19] 3GPP TR 38.901 v15.0.0, 2018-06, Study on channel model for frequencies from 0.5 to 100 GHz.