

DESIGN OF SEMI-AUTOMATED CALIBRATION SYSTEM FOR PRESSURE BALANCES

Ahmet Türk, Abdullah Hamarat, Yasin Durgut

TÜBİTAK Ulusal Metroloji Enstitüsü, TÜBİTAK Gebze Yerleşkesi P.K.54 41470 Gebze, Kocaeli, Turkey
(✉ turk.ahmet@tubitak.gov.tr, +90 262 679 5000, abdullah.hamarat@tubitak.gov.tr, yasin.durgut@tubitak.gov.tr)

Abstract

In this study, a digital manometer was used as a transfer standard to perform calibration of a pneumatic pressure balance. The same pressure balance was calibrated with the cross-floating method based on falling rate determination (FRD). Average of differences among the effective area results show an agreement of less than 10 ppm between the digital manometer-assisted calibration (DMAC) method and the FRD method. The method in which a digital pressure gauge is used as a transfer standard not only facilitates calibration but also enables the automation of pressure balance calibration. Full automation of pressure balance calibration requires an automatic mass loading system for both the reference instrument and the device under test. Since there is a lot of different kinds of pressure balances, it is nearly impossible for a pressure metrology laboratory to have an automatic mass-handler system for every type of pressure balance. Therefore, a more efficient way in which automated mass-handler systems are not required *i.e.*, a semi-automatic calibration system, is designed. For that purpose, two different calibration procedures, increasing-decreasing cycles, and pressurize-vent (P-V) procedures are performed and compared. The equivalence of procedure results makes the semi-automated calibration design of pressure balances possible. The most distinguishing advantages of a semi-automated calibration system are the applicability to any type of pressure balance and low cost compared to full automation.

Keywords: semi-automated calibration, pressure balance, digital manometer assisted method.

© 2022 Polish Academy of Sciences. All rights reserved

1. Introduction

Pressure balances are primary reference instruments that are mainly used for sensitive pressure measurements in pressure metrology. The most important part of pressure balances is the *piston-cylinder unit* (PCU). The piston and cylinder are very well fabricated to have very smooth surfaces and low form errors. The gap between the piston outer surface and cylinder inner surface is of the order of a few microns. Even though that gap is very small, the piston can freely float and rotate in the pressurized fluid in the cylinder cavity thanks to the high geometrical properties of both piston and cylinder. The role of fluid inside a cylinder is to transfer the pressure to the device connected

to the pressure balance. Therein, well-calibrated masses are loaded on the piston to generate target pressure values and the piston is floated and rotated in the fluid. Pressure transferred to the fluid by a piston-cylinder unit is calculated by (1).

$$P = \frac{F}{A_e}, \quad (1)$$

where F is total force (acting on the effective area of the PCU) and A_e is the effective area of the PCU. The effective area is different from the area of the piston. It is the area of a virtual piston whose borders lie between piston and cylinder [1].

Pressure balances have better metrological properties such as low uncertainty, high accuracy, infinite resolution, high repeatability *etc.* when compared to other pressure measuring instruments such as electromechanical and mechanical manometers. Since they are broadly used as primary reference instruments, it is crucial to ensure traceability of pressure balances for pressure metrology laboratories. The traceability of these instruments is provided by calibration of the PCU. Calibration of pressure balances covers the determination of effective area and pressure distortion coefficient. In order to standardize this process in many laboratories, the European Association of National Metrology Institutes has published a calibration guide (EURAMET cg 3) [2]. It describes, *i.a.*, the cross-floating calibration method that is based on finding equilibrium conditions between the reference pressure balance and the pressure balance under test by using small weights [2]. Equilibrium conditions can be found by using piston falling rates or a differential pressure gauge. Cross-floating is a very reliable method and has been generally used for many years by national metrology institutes in many countries. However, it has some disadvantages that make cross-floating difficult. Long calibration period, high operator dependency and high operator effort are some of the main shortcomings of piston gauges calibrations.

Automatization of the cross-floating method has a lot of advantages such as standardizing the calibration process, eliminating operator bias and increasing efficiency. So, automated calibration of pressure measuring devices is a field of interest in pressure metrology. Especially, pressure transducers and digital manometers are appropriate for automated calibration because of their developed data acquisition systems and easy calibration processes [3,4]. As to analogue manometers, it is possible to calibrate analogue devices automatically by using image processing for data acquisition [5]. However, automated calibration of pressure balances is really difficult due to their complicated calibration processes. There are some studies on full automation of pressure balance calibration. According to [6] and [7], full automation of hydraulic pressure balances and pneumatic balances can be successfully performed with the pressure balances that have very special equipment, *i.e.*, an automated mass handler system. These are really important achievements in the field of pressure metrology. However, there are several types of pressure balances in industrial and metrological laboratories and most of which have not automated mass-handler systems. As a result, the applicability of the proposed systems is very limited even for the most developed pressure metrology laboratories. However, pressure metrologists need a more practical and efficient way to calibrate pressure balances. The method proposed in this study, semi-automated calibration, can be a candidate for meeting this necessity. The semi-automated cross-floating calibration method for pressure balances is possible thanks to high precision digital manometers and transducers. In [8], a precise pressure transducer was used to determine the equilibrium state between the reference and test pressure balances. According to the results of the conducted experiments, the results of the proposed method and the falling rate method are compatible with each other. The difference is a few ppm. In the proposed method, automatic valves were used to prevent volume change, pressure distribution and heat transfer to the system as a result of valve

movement. In addition, equal time intervals were used to sample pressure values from pressure balances with the help of precise transducers to eliminate the effect of drift parameter.

Another similar research was described in [9]. A digital transducer was used to calibrate the pressure balance in the 350 kPa range. Before calibrating pressure balance, repeatability, stability and linearity of the pneumatic transducer were examined. The metrological properties of the transducer were interpreted as satisfactory for performing calibration of the pressure balance. Effective area results obtained with the proposed method called *transducer-aided calibration* (TAC) and traditional cross-float based on differential pressure measurement results are close to each other. The difference is less than 6 ppm. Furthermore, mechanical valves were used instead of automatic valves as in the case of reference [8]. The effect of mechanical valves on the calibration results was negligible.

2. Cross-floating method based on falling rate determination

The traditional cross-floating method based on FRD is used to calibrate pressure balances. This method is based on finding equilibrium conditions between reference pressure balance and the pressure balance under test. At equilibrium conditions, pressure values generated by the reference pressure balance and the pressure balance under test are equal [2]. Precise measurements of piston falling rates are used to determine equilibrium conditions of pressure balances. Different *laser distance measurement systems* (LDMS) are thus used to measure falling rates, simultaneously. LDMS is a system which continuously sends infrared light onto a reflector located on the top level of a piston and receives the reflected light from the same reflector. In this way, LDMS automatically measures the vertical position of the piston at any time. An algorithm calculates the mean speed of the piston based on the vertical position change of the piston with time. The calibration setup including different LDMS is given in Fig. 1.

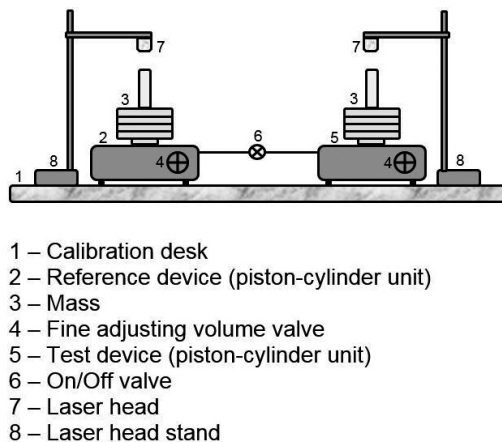

Fig. 1. Cross-Floating calibration setup based on falling rate determination.

In the study, cross-float calibrations based on FRD were performed at seven pressure points in 2 decreasing and 3 increasing cycles. After preloading to warm-up pressure balances, mass combinations corresponding to the first pressure point are loaded to the proper pressure balances. In the case of the valves between the pressure balances being in a closed position, PCU falling rates are precisely measured by the LDMS. Then, the valves between pressure balances are

opened. Next, the operator adds some small weights on the test or reference side, until the same falling rates are reached. The equilibrium condition is reached. when the same falling rates are reached again. In this situation, the pressure values produced by the reference pressure balance and the pressure balance under test are equal. The effective area of the pressure balance under test is calculated using the pressure equality for the corresponding calibration point. Because the effective area is a function of pressure, the same procedure is applied for several pressure points covering the whole range of the test gauge.

3. Digital manometer assisted calibration (DMAC) system

In this method, a digital manometer is used as a transfer standard to calibrate the pressure balance under test against the reference pressure balance. A schematic illustration of the calibration setup is given in Fig. 2. In addition, a photograph of FRD and DMAC setup (together) is shown in Fig. 3. Different valve positions enable to use the same system as an FRD or a DMAC, independently.

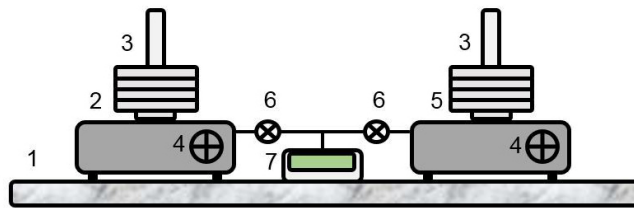

- 1 – Calibration desk
- 2 – Reference device (piston-cylinder unit)
- 3 – Mass
- 4 – Fine adjusting volume valve
- 5 – Test device (piston-cylinder unit)
- 6 – On/Off valve
- 7 – High accurate pressure monitor

Fig. 2. Schematic illustration of digital manometer-assisted calibration setup.

The calibration set-up consists of pressure balance under test, reference pressure balance, mass sets, a digital manometer, two valves, a pressure controller, two temperature probes and a computer software programme. In addition, a temperature-humidity sensor and a barometer are necessary for measuring environmental conditions to calculate air density. The role of a digital manometer in the calibration process is to sample and compare pressure values generated by the pressure balance under test and the reference pressure balance. It is not used as a reference standard but used as a transfer standard. Communication between the digital manometer and computer software programme is established by an RS232 serial communication protocol. The software programme is designed in the LabVIEW™ 2015 environment to acquire pressure values generated by pressure balances from a digital manometer. In this study, we waited for at least 30 seconds for pressure stabilization [10]. 30 pressure readings were acquired for 1 minute for calibration.

First of all, preloading is performed to warm-up electrical and mechanical parts of all instruments in the calibration system. The five steps given below are taken by the operator to complete



Fig. 3. Cross-floating and digital manometer-assisted calibration setup.

the calibration of the first pressure point. Then the same steps are applied to other calibration points.

Step 1: Necessary masses for the current calibration point are loaded on both reference pressure balance and pressure balance under test and they are brought into the floating band. In this situation, valves are closed so that there is no interaction between pressure balances and the digital manometer.

Step 2: The valve between the reference pressure balance and the digital manometer is opened. After waiting enough time for pressure stabilization, the operator runs the software programme and it starts to acquire pressure values from the digital manometer generated by reference pressure balance. After acquiring some number of data specified by the operator, the software programme automatically stops. Then operator closes the valve.

Step 3: The operator opens the valve of the digital manometer and the pressure balance under test. After waiting enough time for pressure stabilization, the operator runs the software programme and it starts to acquire pressure values from the digital manometer generated by the pressure balance under test. After acquiring some data specified by the operator, the software programme stops. Then the valve is closed.

Step 4: The same procedure as in Step 3 is applied for the second pressure sampling of the pressure balance under test.

Step 5: The same procedure as in Step 2 is applied for second pressure sampling of the reference pressure balance.

In addition to pressure values, standard deviations of these pressure values are automatically calculated and recorded by the software programme to use in the uncertainty budget. Waiting and sampling periods for successive steps should be nearly identical to eliminate the drift effect of the digital manometer [10].

3.1. The use of measurement values

In the equilibrium state, pressure values generated by pressure balances are equal to each other. In the equality condition, the effective area of pressure balance under test can be determined by using (2).

$$\frac{F_{\text{test}}}{A_{\text{test}}} = \frac{F_{\text{ref}}}{A_{\text{ref}}} + \Delta h \cdot \Delta \rho \cdot g, \quad (2)$$

where;

- F_{ref} – total force acting on the reference piston in the floating condition,
- A_{ref} – effective area of the reference PCU at pressure P ,
- F_{test} – total force acting on the test piston in the floating condition,
- A_{test} – effective area of the test PCU at pressure P ,
- $\Delta h \cdot \Delta \rho \cdot g$ – head correction.

When a digital manometer is used as a transfer standard, the pressure difference between the reference pressure balance and the pressure balance under test is calculated using measurement values acquired from the digital manometer. It is called RTTR measurement. The difference is calculated according to (3).

$$\Delta p_{\text{measured}} = \left(\frac{P_{T1} - P_{R1} - P_{R2} + P_{T2}}{2} \right), \quad (3)$$

where;

- p_{R1} – first average pressure reading of reference pressure balance from the digital manometer,
- p_{T1} – first average pressure reading of test pressure balance from the digital manometer,
- p_{T2} – second average pressure reading of test pressure balance from the digital manometer,
- p_{R2} – second average pressure reading of reference pressure balance from the digital manometer.

By modifying (2) and (3), (4) is obtained, which is used to calculate the effective area of the test pressure balance:

$$\frac{F_{\text{test}}}{A_{\text{test}}} = \frac{F_{\text{ref}}}{A_{\text{ref}}} + \Delta h \cdot \Delta \rho \cdot g + \Delta p_{\text{measured}}. \quad (4)$$

3.2. Uncertainty Budget

EURAMET cg-3 is an international guide for calibration of pressure balances. The parameters given in this guide are used to calculate the uncertainty for cross-floating with FRD and DMAC. In addition to these parameters, resolution of digital manometer, standard deviations of pressure readings and the differences among $\Delta p_{\text{measured}}$ values are taken into consideration to estimate the effect of the digital manometer on the effective area. In addition to these three parameters, uncertainty due to the repeatability of digital manometer is also evaluated. These parameters given above are combined to show the contribution of $\Delta p_{\text{measured}}$, given in (4), to the total uncertainty.

4. Calibration

A 350 kPa pneumatic PCU was calibrated with the traditional cross-floating method based on falling rate determination and the digital manometer-assisted method. Both of calibrations were performed at seven calibration points which are 10%, 20%, 40%, 50%, 60%, 80% and 100% FS. In addition to decreasing-increasing cycles performed with the FRD and DMAC methods, a different calibration procedure (P-V procedure) was used for the pneumatic PCU calibration.

4.1. Cross-floating method with falling rate determination

The cross-floating of the 350 kPa pneumatic PCU was performed according to rules specified by the EURAMET cg 3 calibration guide [2]. The equilibrium condition of pressure balances was evaluated by measuring falling rates of reference and test instruments. Different LDMS were

used to measure the falling rates. The results of the cross-floating calibration based on falling rate determination are illustrated in Fig. 4. The difference between the maximum and the minimum effective area value is 9 ppm. Standard deviation for all effective area values is 2.3 ppm. The difference between A_0 (effective area at atmospheric pressure) and mean A_p (effective area at pressure p) is only 1 ppm. According to the results, A_p values do not scatter much.

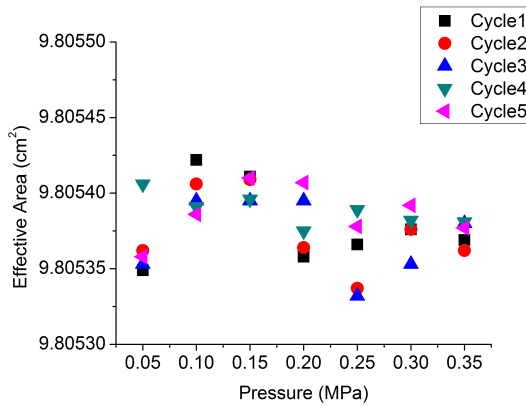

Fig. 4. Effective area results based on the falling rate determination.

4.2. Digital manometer-assisted calibration (DMAC) method

The digital manometer used in this method is a 700 kPa Fluke RPM4 with a barometric sensor. According to the technical data sheet [11], it has the measurement uncertainty of $\pm 0.010\%$ of reading or 0.0030% of Q-RPT span, whichever is greater. The resolution of the digital manometer is set to 0.1 Pa. It is important to take the effect of atmospheric pressure changes into consideration, especially for low gauge pressure sampling of reference and test instruments. According to [12], the digital manometer can detect the atmospheric pressure changes during the measurement and correct the pressure reading automatically.

The same calibration procedure applied for FRD was followed in DMAC. Calibration results for DMAC are given in Fig. 5. Maximum difference among A_p values is 16 ppm and standard

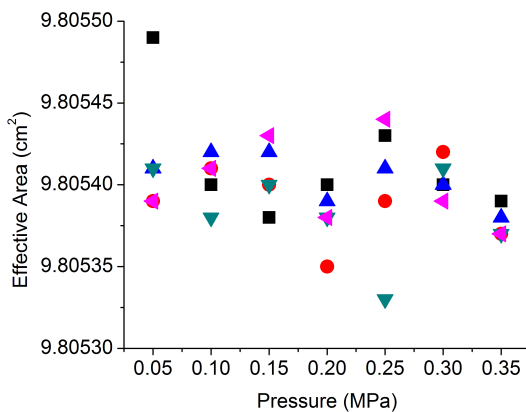

Fig. 5. Effective area results for the digital manometer-assisted method.

deviation is 2.8 ppm. The difference between A_0 and mean A_p is 2 ppm. A_p values of DMAC are generally higher than FRD.

4.3. Pressurize and vent (P-V) procedure for calibration

The calibration procedure followed in this study are 3 increasing and 2 decreasing cycles including seven calibration points, as described in Section 2. Cross-Floating Method Based on Falling Rate Determination.

Pressure balances do not show a significant hysteresis effect [2]. As a result, instead of applying 3 increasing and 2 decreasing cycles, 5 measurements are performed at the same calibration point one after another. After taking one measurement at one calibration point, the pressure is released into the atmosphere and the system is pressurized again to the same calibration point to take the next measurement. This cycle is repeated when 5 measurements are performed at the same point. Then the same procedure is followed for other calibration points. It will be called the P-V (pressurize and vent) procedure.

Another calibration was performed by using the P-V procedure for a pneumatic PCU which had been calibrated before by using FRD and DMAC, as explained in Sections 4.1 and 4.2. In the new calibration, only the digital manometer-assisted method is used by applying the P-V procedure (DMAC P-V). Calibration results for DMAC P-V are given in Fig. 6. Maximum difference among A_p values is 13 ppm and standard deviation is 2.6 ppm. The difference between A_0 and mean A_p is 2 ppm. A_p values of DMAC P-V are also generally higher than those for FRD.

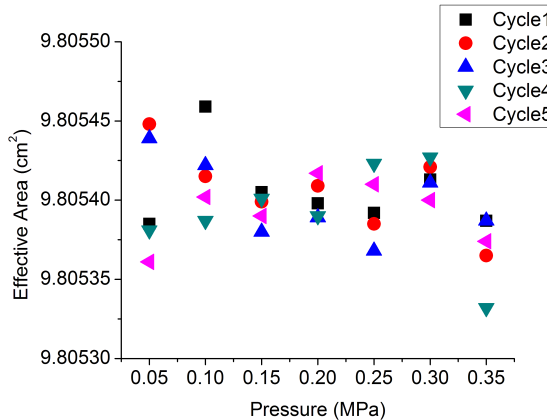

Fig. 6. Effective area results for the digital manometer assisted method (P-V).

4.4. Comparison of results

Maximum difference among A_p values of DMAC, DMAC P-V and FRD is approximately 15 ppm. The maximum difference is at the first measurement point *i.e.*, 0.5 MPa. The repeatability values of effective areas for the FRD method are better than the values for DMAC and DMAC P-V. The ratios of effective area standard deviations are illustrated in Fig. 6. The ratios are figured out by dividing standard deviations of DMAC and DMAC P-V by standard deviations of the FRD method. It is obvious from Fig. 6 that either most of the results are higher than or very close to 1. According to Figs. 4–7, A_p values of DMAC and DMAC P-V are scattered more than the results

in the FRD method. It shows that the FRD method is more sensitive than DMAC and DMAC P-V. On the other hand, A_p values of DMAC are more dispersed than the values of DMAC P-V.

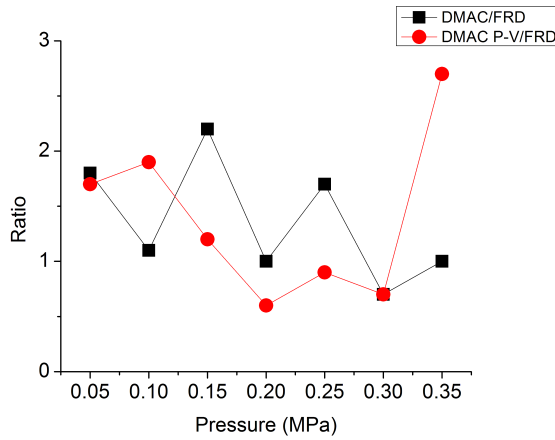

Fig. 7. The ratio of standard deviations of effective areas at different pressure points.

Uncertainty budget for FRD [2] and relative contributions at 0.5 MPa are given in Table 1. The most significant contribution to the uncertainty stems from type A and mass uncertainty, at lower pressure values. However, as the pressure increases, uncertainty contribution from type A is more dominant. Uncertainty of A_p values tends to decrease as the pressure increases. Maximum relative standard uncertainty is 8 ppm ($k = 1$).

Table 1. Uncertainty budget for the FRD method and relative contributions ($k = 1$) at 0.5 MPa.

Parameter	Relative uncertainty contribution at 0.5 MPa
Type A	4 ppm
Mass	4 ppm
Local gravity acceleration	< 1 ppm
Density of air	< 1 ppm
Density of pressure-transmitting fluid	< 1 ppm
Reference pressure	3 ppm
Density of mass	< 1 ppm
Thermal expansion coefficient of PCU	2 ppm
Temperature of PCU	3 ppm
Cross-floating sensitivity	2 ppm
Height difference	< 1 ppm
Tilt of the piston	< 1 ppm
Combined Uncertainty ($k = 1$)	8 ppm

A digital manometer was used to sample pressure values of reference PCU and test PCU in DMAC and DMAC P-V. For every pressure point, 30 pressure readings were acquired from the digital manometer. Standard deviations of these pressure reading are used as a parameter for the

uncertainty budget of DMAC and DMAC P-V. As it is obvious from Fig. 8, standard deviations tend to increase as the pressure value increases. However, relative uncertainty contribution of standard deviations to the effective area is higher at lower pressure points. Standard deviations at DMAC P-V are slightly lower than those for DMAC.

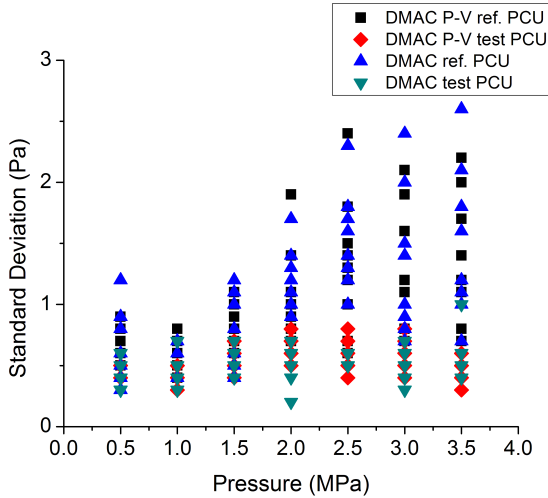

Fig. 8. Standard deviations of pressure readings.

Uncertainty budget for DMAC and DMAC P-V include entirely the same parameters. In addition to the parameters given in Table 1 (except cross-floating sensitivity), resolution of digital manometer, difference of $\Delta p_{\text{measured}}$ and standard deviations of pressure readings are included in the uncertainty budget for DMAC and DMAC P-V. Total contribution of these three parameters is given in Fig. 9. According to the figure, maximum contribution is at the lowest pressure point. Moreover, DMAC gives slightly higher uncertainty values rather than DMAC P-V.

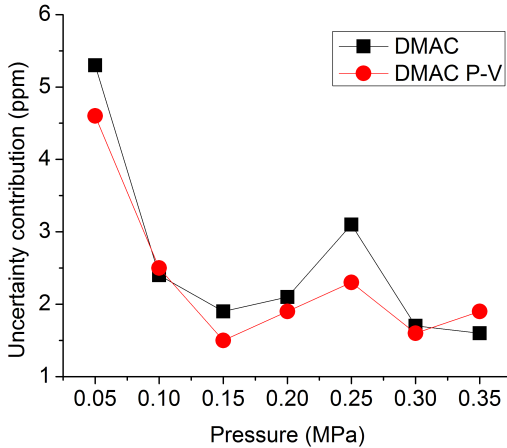

Fig. 9. Uncertainty contribution due to the resolution of the digital manometer, difference of $\Delta p_{\text{measured}}$ and standard deviations of pressure readings ($k = 1$).

In addition to the uncertainty parameters given above, the repeatability and linearity of the digital manometer are two other uncertainty parameters affecting the results for the effective area. Repeatability is a measure of how close a digital manometer's pressure readings are under the same conditions. According to the technical note on the digital manometer [13], the Fluke RPM4 has $\pm 0.0020\%$ of rdg standard uncertainty due to repeatability. When the uncertainty value of repeatability is added to the uncertainty budget, the total uncertainty for DMAC and DMAC P-V increases to the order of 22 ppm ($k = 1$).

On the other hand, when the reference and test pressure measurements are examined at every point, the uncertainty arising from the repeatability of the digital manometer is calculated lower. When calculating repeatability, the maximum difference between the pressure readings within the reference and the test itself, in the same RTTR measurement, is taken into account. Relative uncertainty contributions due to repeatability are given in Fig. 10. When the calculated uncertainty values for repeatability are taken into consideration, maximum combined uncertainty is calculated as 11 ppm ($k = 1$) and 13 ppm ($k = 1$) at 0.05 MPa for DMAC and DMAC P-V, respectively. As is obvious from Figs. 9 and 10, uncertainty values of DMAC and DMAC P-V get closer to uncertainty values of FRD as the pressure increases.

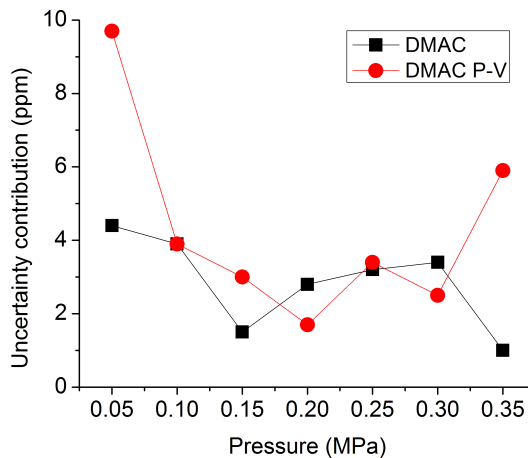

Fig. 10. Uncertainty contribution due to repeatability ($k = 1$).

As to the linearity, since the test and reference pressure values are closer to each other, it is assumed that the digital manometer is sufficiently linear. Furthermore, results of calibrations show that the digital manometer used in this study is suitable for DMAC calibrations.

5. Semi-automated calibration design

Pressure balance calibration is one of the most difficult and time-consuming calibrations in the field of metrology. Today fully automatic calibration of pressure balances can be performed for the same type of pressure balances. Full automation requires an automatic mass handler system for both test and reference instruments. Since there are a lot of different kinds of pressure balances, it is nearly impossible or very expensive to have a compatible mass handler system for every kind of base and mass set of pressure balances. Therefore, a more efficient way of automated calibration of pressure balances is designed. The design is not expensive compared to

a fully automated system due that it is not necessary to have any automated mass handler system. In addition, a semi-automated calibration design can be applied to any type of pressure balance. A semi-automated design is shown in Fig. 11.

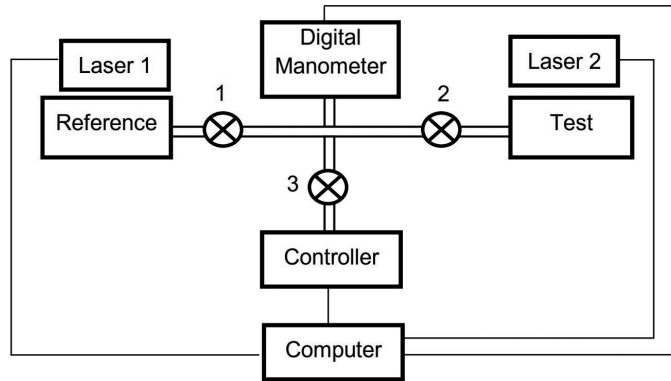

Fig. 11. Design of semi-automated pressure balances.

According to the design, semi-automated calibration of a pressure balance can be accomplished using a pressure controller, two laser distance measurement systems, a digital manometer, three automatic valves, and a computer for the software. The pressure controller is necessary to pressurize the system. The laser distance measurement systems are required to determine the vertical position of the test and reference pistons. The digital manometer is necessary to sample pressure values generated by the reference pressure balance and the pressure balance under test when they are in the floating band. In this way, the pressure difference between the test and the reference instrument can be measured. Automatic valves are used to sample pressure values via the same digital manometer from the reference pressure balance and the pressure balance under test independently. In addition to these devices, two temperature probes to measure reference and test PCU temperatures, a humidity and temperature probe to measure ambient humidity and temperature, and a barometer to measure atmospheric pressure are required. If the pressure balances do not have any motors to rotate them, a motor-driven system will be necessary for semi-automation.

A detailed description of semi-automated calibration is given in steps 1–7. Also, a flow chart of the measurement procedure is given in Fig. 12.

Step 1: The operator determines the upper and lower floating band limits of PCUs and enters them in the software.

Step 2: The operator loads the necessary mass combination which corresponds to the first calibration point on both test and reference pressure balances.

Step 3 (P_{R1}): Valves 1 and 3 are opened. The pressure controller pressurizes the system until the reference PCU reaches its upper floating-point. Then Valve 3 is closed and the reference piston is rotated. The software program continuously checks the level of the reference piston. If the reference piston is outside its floating band, it opens Valve 3 and starts to pressurize the reference piston until it reaches its upper floating point. After 1 minute, if the reference piston is inside its floating band, the software program starts to acquire pressure data from the digital manometer. After each measurement, the software checks whether the reference PCU is inside its floating band or not. If it is inside the floating band, the next reading is done. Otherwise, it restarts the Step 3 procedure. After 30 pressure readings for 1 minute are acquired, Step 3 is completed.

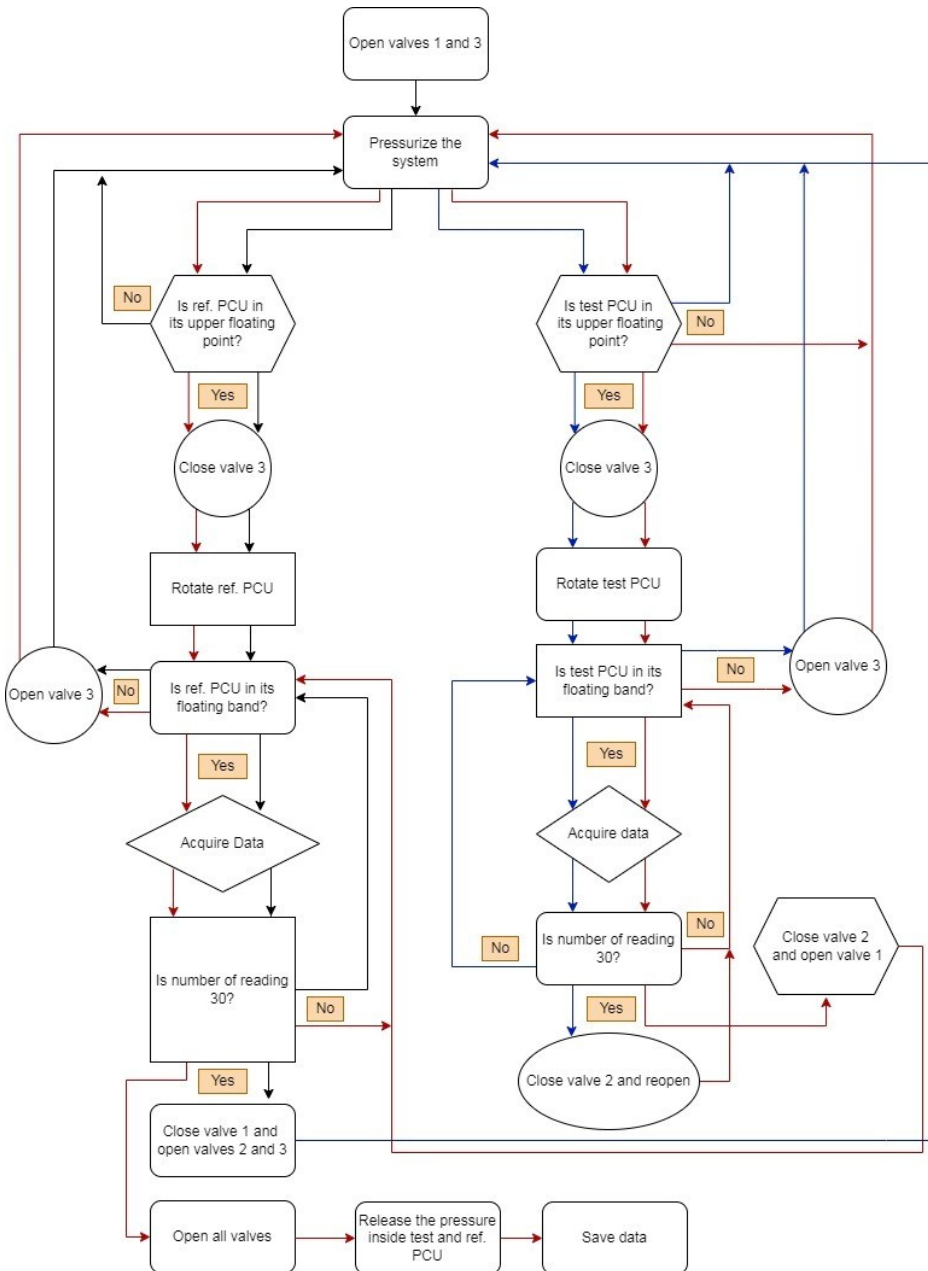

Fig. 12. Flow chart for semi-automated calibration software (priority of colours: black, blue, red).

At the end of Step 3, Automatic Valve 1 is closed and Automatic Valves 2 and 3 are opened.

Step 4 (P_{T1}): The pressure controller pressurizes the system until the test PCU reaches its upper floating-point. Then Valve 3 is closed and the test piston is rotated. The software program

continuously checks the level of the test piston. If the test piston is outside its floating band, it opens Valve 3 and starts to pressurize the test piston until it reaches its upper floating point. After 1 minute, if the test piston is inside its floating band, the software program starts to acquire pressure data from the digital manometer. After each measurement, the software checks whether the test PCU is inside its floating band or not. If it is inside the floating band, the next reading is done. Otherwise, it restarts the Step 4 procedure. When 30 pressure readings are acquired, Step 4 is completed.

At the end of Step 4, Automatic Valve 2 is closed and reopened.

Step 5 (P_{T2}): The level of the test PCU is checked. If it is in the floating band, 30 pressure data are acquired. Otherwise, Valve 3 is opened and the Step 4 procedure is followed from the beginning.

At the end of Step 5, Valve 2 is closed and Valve 1 is opened.

Step 6 (P_{R2}): The level of the reference PCU is checked. If it is in the floating band, 30 pressure data are acquired. Otherwise, Valve 3 is opened and the Step 3 procedure is followed from the beginning.

Step 7: Finally, the pressure inside the reference and the test PCUs are released.

6. Conclusions

Thanks to their sensitive pressure measurement capabilities, piston pressure standards are widely used devices in pressure metrology. Reciprocating pressure standard devices also need to be calibrated periodically. Various methods have been proposed for calibration of this type of devices in the international guide document [2] published for this purpose.

In this study, the calibrations conducted in pneumatic media with the *digital manometer assisted calibration* (DMAC) method are found to be compatible with the FRD cross-float method. The transducer or digital manometer-assisted calibration method attracts the attention of researchers because it provides metrologists with automation of pressure balance calibration. When the measurement results are compared, it can be seen that the average of differences were of the order of less than 10 ppm. In the performed measurements, it can be seen that the DMAC method is very useful in reducing the dependency on the operator in the calibration of such devices, preventing possible errors and significantly reducing the time spent in calibrations.

In addition, to compare the results by trying different methods, within the DMAC method, the pressure-vent (P-V) method was also applied. In the DMAC method, the masses loaded on the piston are changed again as they pass from one pressure point to the other in increasing and decreasing directional cycles, and in this way, a total of 30 mass loading and unloading processes after 5 cycles need to be carried out. But in the P-V method, the calibration system was loaded to the target pressure 5 times by using the masses loaded on the PCU for each pressure point. In this way, instead of loading and unloading the mass 30 times, this process was repeated only 6 times. So, the P-V method both reduced the possibility of incorrect mass loading and shortened the calibration period.

Bearing this in mind, a calibration measuring device has been designed that will allow the DMAC and P-V method to be applied together and the pressure-balance devices to be calibrated with the semi-automatic method at the expense of higher uncertainty, and the general structure and working style of this method have been explained in this publication and planned for future works.

Moreover, full automation of pressure balances needs a mass handler system that automatically loads the necessary mass combination on the piston according to the desired pressure value. An

automatic mass handler system is specific to the type of pressure balance. It is thus very difficult and expensive to apply full automation to every type of pressure balance. On the other hand, semi-automation in which necessary mass combinations are loaded on the piston by the operator may prove more practical. For this purpose, a different procedure for increasing-decreasing cycles named the P-V procedure is applied for the low-pressure pneumatic medium. The agreement of results with the traditional cross-float makes semi-automatic calibration of pressure balances more effective.

When compared to a fully automatic calibration system, semi-automated calibration of pressure balances is more practical and easier to apply. It provides pressure metrologists with lots of advantages such as decreased operator dependency on the calibration process and errors originating from the operator, elimination of negative effects of operator bias, as well as increasing the standardization, quality and reliability of the calibration process. It saves time to pressure metrologists and increases the efficiency.

References

- [1] Dadson, R. S., Lewis, S. L., & Peggs, G. N. (1982). *The Pressure Balance: Theory and Practice*. HMSO.
- [2] EURAMET e.V., & Technical Committee for Mass (2011). *Calibration of Pressure Balances* (Calibration Guide ver. 1.0). <https://www.euramet.org/publications-media-centre/calibration-guidelines>
- [3] Türk, A., & Hamarat, A. (2019, June). Automated Pressure Calibration of Blood Pressure Measuring Device Calibrator To Realize Its Traceability. In *2019 IEEE International Symposium on Medical Measurements and Applications (MeMeA)* (pp. 1–5). IEEE. <https://doi.org/10.1109/MeMeA.2019.8802215>
- [4] Türk, A., Hamarat, A., & Karaböce, B. (2020, June). Comparison of manual and automated pressure calibration methods of medical pressure calibrator. In *2020 IEEE International Symposium on Medical Measurements and Applications (MeMeA)* (pp. 1–6). IEEE. <https://doi.org/10.1109/MeMeA49120.2020.9137288>
- [5] Alegria, E. C., & Serra, A. C. (2000). Automatic calibration of analog and digital measuring instruments using computer vision. *IEEE Transactions on Instrumentation and Measurement*, 49(1), 94–99. <https://doi.org/10.1109/19.836317>
- [6] Kobata, T. (2007, November). A fully automated calibration system for pressure balance. In *IMEKO 20th TC3, 3rd TC16 and 1st TC22 Int. Conf; Cultivating metrological knowledge*. <https://www.imeko.org/publications/tc16-2007/IMEKO-TC16-2007-041u.pdf>
- [7] Yang, Y., Driver, R. G., Quintavalle, J. S., Scherschligt, J., Schlatter, K., Ricker, J. E., Strouse, G. F., Olson, D. A., & Hendricks, J. H. (2019). An integrated and automated calibration system for pneumatic piston gauges. *Measurement*, 134, 1–5. <https://doi.org/10.1016/j.measurement.2018.10.050>
- [8] Kobata, T., & Olson, D. A. (2005). Accurate determination of equilibrium state between two pressure balances using a pressure transducer. *Metrologia*, 42(6), S231. <https://doi.org/10.1088/0026-1394/42/6/S19>
- [9] Scherschligt, J., Olson, D. A., Driver, R. G., & Yang, Y. (2016). Pressure balance cross-calibration method using a pressure transducer as transfer standard. *NCSLI Measure*, 11(1), 28–33. <https://doi.org/10.1080/19315775.2016.1149003>
- [10] EURAMET e.V., Technical Committee for Mass, & Related Quantities (2019). *Guidelines on the Calibration Electromechanical of and Mechanical Manometers* (Calibration Guide No. 17, Version 4.0).
- [11] Fluke. (2021). *RPM4™ Reference Pressure Monitor* (Technical data).

- [12] Fluke. (2012). *RPM4 Reference Pressure Monitor (Operation and Maintenance Manual)*.
- [13] Fluke. (2011). *Guide to determining pressure measurement uncertainty for Q-RPT based products (Technical Note)*.



Ahmet Türk received his B.Sc. degree from the Department of Mathematics and Science Education Boğaziçi University, Turkey, in 2007 and his M.Sc. degree from the Department of Physics, of Gebze Technical University, Turkey, in 2019. The thesis was on the effective area calculation of pressure balances by using the dimensional measurement method. He has been pursuing a Ph.D. degree at Department of Physics of Gebze Technical University since 2021. He has also been

working as a pressure metrologist at TÜBİTAK UME for more than eight years.



Abdullah Hamarat received his B.Sc. degree from the Department of Mechanical Engineering, İstanbul Technical University, in 1996 and his M.Sc. degree from the Institute of Science and Technology of the Department of Energy of the same university. After graduation, he worked in various fields such as energy technical service and project management in the private sector. He worked as a project and laboratory manager in years 2007–2018. He has been working as a researcher

at TÜBİTAK UME pressure laboratory for more than nine years (2002–2007 and 2018–now).



Yasin Durgut graduated from the Department of Electrical and Electronic Engineering of Dokuz Eylül University, Turkey, in 1997. He completed his Ph.D. thesis on “Research and Development of Dynamic Pressure Measurement Standards” at Yeditepe University Physics Department and received his doctorate degree. Between 2000–2004, he worked in various telecommunication projects at Alcatel Telekomünikasyon A.Ş. In 2006, he graduated from the Open

Education Faculty Business Administration Department, Anadolu University. He is a member of the Project Management Institute and has a PMP (Project Management Professional) certificate from this institute. He has been working as a researcher at Pressure Laboratories of TÜBİTAK UME since 2004 and as Head of Pressure Laboratory since 2015. He has over 50 published SCIE, Scopus, Google Scholar-indexed journal articles and papers presented at various national and international congresses.