





DOI 10.24425/ae.2023.143693

Maximum power point tracking techniques for low-cost solar photovoltaic applications – Part I: constant parameters and trial-and-error

TOLE SUTIKNO¹  , ARSYAD CAHYA SUBRATA¹ , GIOVANNI PAU² , AWANG JUSOH³ ,
KASHIF ISHAQUE⁴ 

¹*Department of Electrical Engineering, Universitas Ahmad Dahlan
Yogyakarta, Indonesia*

²*Faculty of Engineering and Architecture, Kore University of Enna
Italy*

³*School of Electrical Engineering, Faculty of Engineering, Universiti Teknologi Malaysia
Johor Bahru, Malaysia*

⁴*Capital University of Science and Technology
Islamabad, Pakistan*

*e-mail: [✉ tole/arsyad.subrata]@te.uad.ac.id,
giovanni.pau@unikore.it, awang@fke.utm.my, kashif.ishaque@jinnah.edu*

(Received: 30.03.2022, revised: 02.11.2022)

Abstract: The development of research on the maximum power point tracking (MPPT) controller has increased significantly in this decade. The MPPT technique, however, is still demanding because of the ease and simplicity of implementing tracking technique on the maximum power point (MPP). In this paper, MPPT techniques and their modifications from various literature are classified and examined in detail. The discussions are focused on the main objective of obtaining the best possible MPPT technique with the best results at a low cost. The assessment for the selection of MPPT techniques is based on assessments from the previous literature. The discussion of the MPPT technique assessment is divided into two parts. In Part I, the MPPT technique based on constant parameters, and trial-and-error will be discussed in detail, along with its algorithm development in recent times.

Key words: incremental conductance, maximum power point tracking, measurement and comparison, perturb and observe, solar photovoltaic, trial-and-error



© 2023. The Author(s). This is an open-access article distributed under the terms of the Creative Commons Attribution-NonCommercial-NoDerivatives License (CC BY-NC-ND 4.0, <https://creativecommons.org/licenses/by-nc-nd/4.0/>), which permits use, distribution, and reproduction in any medium, provided that the Article is properly cited, the use is non-commercial, and no modifications or adaptations are made.

1. Introduction

Solar energy (PV) is considered the most potentially sustainable energy resource in renewable energy issues. It is even considered to be one of the best green energy resources among other renewable energy resources to replace conventional energy sources, which are related to the environmental problems [1–4]. This energy source offers abundant energy with minimal environmental hazards. Generating electricity from solar energy sources clearly does not deplete natural resources, does not result in greenhouse emissions such as CO₂ and NO_x or toxic gases such as SO₂ and its particulates, does not produce liquid or solid waste products, reclaims degraded land, reduces transmission lines and electricity grids, and increases the quality of water resources, increasing regional and national energy independence, diversification, and security of energy supplies, as well as accelerating rural electrification, especially in developing countries [5, 7, 8]. Therefore, researchers have developed a renewable energy concept based on photovoltaic (PV) for this reason. It was even reported earlier in the decade that the PV energy sector was growing by more than 30% per year [9]. Besides, easy maintenance and long life are the advantages of the cost-side. Furthermore, the installation of large-scale PV-based power generation systems can help improve the economy in the household sector, health care, agriculture, education, and even the industrial sector [10].

However, PV systems have non-linear characteristics which are affected by environmental conditions such as temperature and irradiation. These varying conditions cause the maximum power point (MPP) generated by PV to vary according to conditions that affect it. To track the MPP, a method that has been developed over the last decade is maximum power point tracking (MPPT). Since the low energy conversion of the PV system is a major obstacle to PV-based power generation, it is necessary to have an MPPT system capable of optimally tracking the MPP in order to ensure maximum power extraction from the PV system making it more reliable and efficient [11–13]. Furthermore, MPPT is considered to be the most economical way to upgrade the overall PV system alongside other major works [14, 15].

Over the past decade, many MPPT algorithms have been in demand and studied by many researchers due to their convenience and simplicity. A number of articles have discussed and reviewed the MPPT techniques with variations in their discussion and classification. Subudhi and Pradhan [13], Verma *et al.* [16], Esham and Chapman [17], Ali *et al.* [18], Kamarzaman and Tan [19], Bendip *et al.* [20], Gupta *et al.* [21], Podder *et al.* [22] describe a review and classification of MPPT techniques with their development variables, such as control variables (sensors), circuitry, cost, complexity, stability, etc. The articles are limited to a comparison of the methods for building variables and their performance. In other studies, Tajuddin *et al.* [23], Danandeh and Mousavi [24], Bollipo *et al.* [25], Karami *et al.* [26], Mao *et al.* [27] discussed the remarks, merits, and demerits, or the advantages and disadvantages, of each method. However, most studies underwent selection criteria to select the best MPPT technique. This paper proposes a simple explanation to determine the best alternative to the MPPT technique. In this paper, an assessment is given to get a score on each of the criteria. The assessment for the selection of MPPT techniques is based on assessments from the previous literature. The assessments based on criteria such as sensors, analog/digital requirements, cost-effectiveness, simplicities, stabilities, efficiencies, and tracking speeds are presented. The results obtained show some of the best methods based on each criterion. This paper aims to provide facilities for PV system installation

developers to determine the best conventional MPPT method according to their needs. In Part I, the discussion focuses on constant parameters, and trial-and-error methods. Furthermore, the parameters to consider in selecting the MPPT technique will be discussed in-depth in Part II.

2. Maximum power point tracking (MPPT)

PV systems offer continuous power harvesting. However, the installation of a PV system suffers from huge costs due to the factors of the PV installation area itself. Therefore, low-cost MPPT can reduce costs by optimizing power harvesting at a low price. The maximum power from the PV module can be extracted by matching the MPP with the converter operating voltage and current. The application of the MPPT system is very wide, namely by connecting to a DC–DC converter or connecting to a network [28]. In the case of connecting to the network, the DC–DC converter is replaced by an inverter. Basically, the MPPT PV system connected to a DC–DC converter is shown in Fig. 1. The MPPT work sequence in the PV system first senses the PV voltage and current with a voltage and current sensor. The sensed values are then entered into the MPPT block. At this stage, the MPP is calculated at a specific sampling cycle. Once the MPP value is found, the MPPT block provides a reference value for the voltage and current (or just one of the variable voltages or currents) matched by the converter. Furthermore, the measured power values are compared with the MPP values. If there is a difference between the rated power and MPP, the duty cycle of the converter (control output) will be adjusted to reduce the difference.

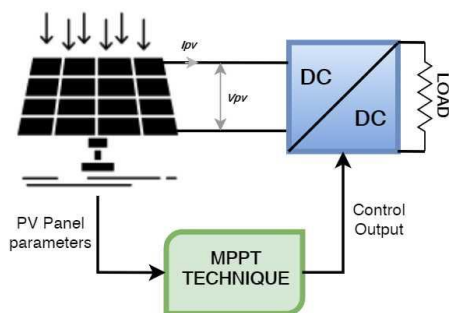

Fig. 1. Basic MPPT block diagram on a PV system connected to a DC–DC converter

It should be noted that the main purpose of applying MPPT is to ensure maximum power is extracted from the PV module in any weather conditions. In this case, what is meant is the conditions of PV exposure to solar irradiation and the temperature of the PV module. Changes in temperature and irradiation will result in changes in the characteristics of the $I - V$ curve. The resulting curve is also influenced by the PV model used. PV modeling requires mandatory data in the form of open-circuit voltage (V_{oc}), short-circuit current (I_{sc}), maximum power voltage (V_{mp}), and maximum power current (I_{mp}). Other parameters needed are photovoltaic current (I_{pv}), diode saturation current (I_0), series resistance (R_s), parallel resistance (R_p), and diode ideality factor (a). This characteristic curve becomes important to examine since the efficiency of the system depends on the operating point of the PV characteristic curve [29].

The effects of temperature and irradiation variation produce non-linear current-voltage characteristics. To simplify this explanation, it can be seen in Fig. 2. The $I - V$ and $P - V$ curves are formed due to variations in temperature and irradiation. As shown in Fig. 2, the MPP is not always at a fixed point but varies based on temperature and irradiation. The solar cell I_{sc} is a function of irradiation and its efficiency decreases as irradiation decreases. Whereas as the temperature rises, V_{oc} rises, but I_{sc} falls logarithmically [16].

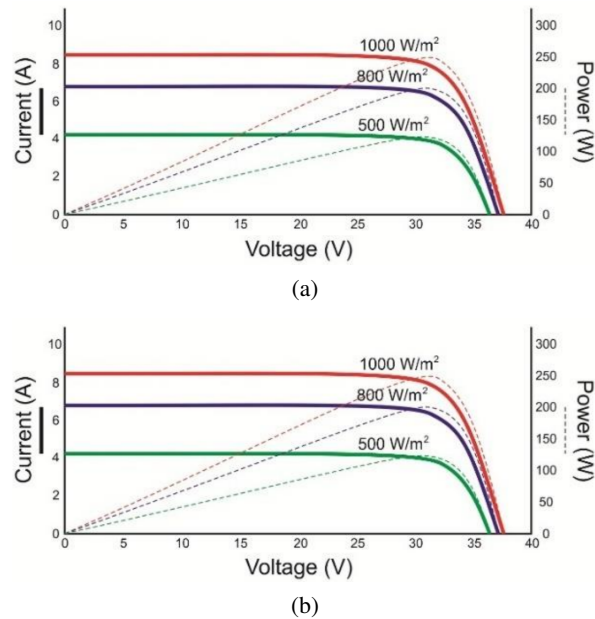

Fig. 2. Characteristic curves of the $I - V$ and $P - V$, at condition: (a) fixed temperature and changing irradiation; (b) changing temperature and constant irradiation

The MPPT technique is oriented towards considering the problem of automatically finding the V_{mpp} voltage or I_{mpp} current at which the PV must operate to get the maximum output power P_{mpp} under a certain temperature and irradiation. The easiest MPPT technique to solve this problem is to use conventional methods. This method is easy and inexpensive to implement, so many commercial MPPT products use this method for simple purposes. However, some basic conventional methods lack the stability and efficiency of tracking results. In addition, at a steady-state condition, the use of this method also causes oscillations around the MPP. The tracking speed towards the MPP is another obstacle to this method. Therefore, the modifications were made with the aim of reducing deficiencies in basic conventional methods. The modifications made are expected to provide better stability, efficiency, and tracking speed than basic conventional methods. The oscillations that occur around the MPP by basic conventional methods need to be suppressed as well. However, the more sophisticated the modification method, the more complex the algorithm will be. This complex algorithm, however, must be able to be handled by a sophisticated processor. Understandably, the more sophisticated the processor used, the more it costs. Of course, this will be a problem when referring to the terms of cheap energy resource systems.

Apart from the need for advanced MPPT techniques and inexpensive processors, up to now, there have been several processing devices that offer their respective advantages. For the purpose of implementing the MPPT technique on a cheap yet reliable PV system, various aspects need to be considered. Starting from the aspects of MPPT techniques, the need for supporting devices for processing devices will be explained in the next section.

3. MPPT techniques

MPPT techniques are classified into 4 categories based on:

- i) constant parameters,
- ii) trial-and-error,
- iii) mathematical calculation, and
- iv) measurement and comparison.

The first two techniques will be discussed in this section, and the remaining two techniques will be discussed in Part II.

3.1. Based on constant parameter

These techniques perform MPP tracking based on predefined values. The basic description and related work of the MPPT techniques based on constant parameters are summarized in Table 1, and the details are explained below.

Table 1. Basic description and related works of the MPPT techniques based on constant parameter

MPPT technique	Description of the technique	Related works
Open-circuit voltage/short-circuit current	<ul style="list-style-type: none"> – Open-circuit voltage: PV voltage ratio is assumed in maximum power point (V_{mpp}) and open-circuit voltage (V_{oc}) is constant. – Short-circuit current: PV current ratio is assumed in maximum power point (I_{mpp}) and short-circuit current (I_{sc}) is constant. – Open-circuit voltage is superior than short-circuit current technique. Compared to short-circuit current, open-circuit voltage technique will result in simple hardware with higher efficiency and lower noise and cost [30]. – Advantages: Simple and fast to track MPP – Disadvantages: It is difficult to determine k parameter in optimal value. If a PV pilot is added for improving the technique, additional cost is needed. 	<ul style="list-style-type: none"> – Bharath and Suresh [31] proposed fractional open-circuit voltage technique. The panel must be disconnected from the load to calculate V_{oc} and I_{sc}. – Without disconnecting the PV panel, Leedy <i>et al.</i> [32] proposed a pilot PV to calculate V_{oc}. – Literature [33–35] proposes a circuit to sample solar panel voltage and current by shortening the reading time. – Asim <i>et al.</i> [36] added a simple analog feed forward PWM controller to track MPP by automatically adjusting the reference voltage. – Baimel <i>et al.</i> [37] proposed a semi-pilot PV which has two functions, the first as a supply to the load, and as a pilot PV for measuring open circuit voltage.

Continued on next page

Table 1 [cont.]

MPPT technique	Description of the technique	Related works
Temperature parametric	<ul style="list-style-type: none"> – This method is based on the effect of irradiation and temperature on the current and voltage of the generated PV module. – This method allows direct MPP prediction with an equation so as to linearize the optimal voltage, cell junction temperature, and solar irradiance. – Advantages: Simple and fast to track MPP, widely adopted at low-cost applications. – Disadvantages: Not stable at steady-state condition. 	<ul style="list-style-type: none"> – Parametric temperature modification carried out by El Mentaly <i>et al.</i> [38] based on a 3D linear regression model. The linear regression used allows this method to be performed in real-time to track MPP. Each PV module does not have the same optimal voltage for the same temperature and sunlight.
Voltage/current feedback	<ul style="list-style-type: none"> – Based on the error between the PV and the constant PV voltage or current is used to adjust the duty cycle of the DC–DC converter. – This method uses only one feedback loop control, making implementation economical. – Advantages: Cheap and simple. – Disadvantages: Unable to handle varying climatic conditions, low efficiency. 	<ul style="list-style-type: none"> – Karanjkar <i>et al.</i> [39] proposes an improvised current feedback technique to track MPP under changing weather conditions. The proposed method adopts PID control tuned by the relay tuning method. – Sanjeevikumar <i>et al.</i> [40] developed an MPPT controller with two sensors as feedback in a proportional-integral closed loop (P–I).
P–N junction drop voltage	<ul style="list-style-type: none"> – This method based on the relationship between the temperature characteristics of the PV cell and the p–n junction diode. – The p–n junction voltage drop is used as the tracer reference voltage. – Advantages: Cheap and simple. – Disadvantages: Inaccurate as it only considers the effect of temperature. 	<ul style="list-style-type: none"> – Kobayashi <i>et al.</i> [41] named the “excellent operating point tracker” due to the fact that the temperature characteristics of the p–n junction diode are the same as that of the solar array.

3.1.1. Open-circuit voltage/short-circuit current

In this article, the open-circuit voltage and short-circuit current methods are discussed because these two methods have similar principles. The open-circuit voltage method works by assuming that the ratio of the solar panel voltage at maximum power (V_{mpp}) and the open-circuit voltage (V_{oc}) is constant. Whereas in the short-circuit current method, the ratio of the solar panel current at maximum power (I_{mpp}) and short-circuit current (I_{sc}) is constant. The fractional open-circuit voltage method is basically carried out by literature [42] and [43], which is implemented on high concentration PV and PV energy harvesters. The short-circuit current method is basically described by the literature [44] and [45]. Meanwhile, literature [46] and [47] apply it to the grid-connected.

The constant values for the open-circuit voltage and short-circuit current methods are found in Eqs. (1) and (2), respectively. The difficult thing in this method is to determine the constant k at the optimal value. Literature [30, 48–53] found k values varied between 0.73 and 9.2. The algorithm of this method is shown in Fig. 3. Assuming a constant reference voltage or current, the effects of temperature and irradiation are eliminated, so that this method is considered the simplest method. The simple algorithm of this method produces no oscillations around the MPP. However, the resulting MPP value is not the true MPP value.

$$k = \frac{V_{mPP}}{V_{oc}}, \tag{1}$$

$$k = \frac{I_{mPP}}{I_{sc}}. \tag{2}$$

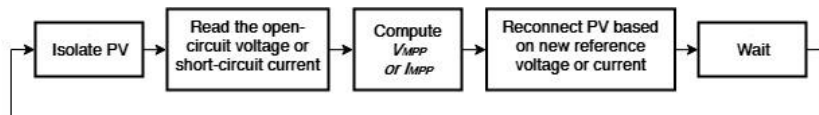

Fig. 3. Algorithm for the open-circuit voltage/short-circuit current method

The obstacle that is often faced when applying this method is the difficulty of calculating the optimal constant value, which causes low efficiency. This problem is also caused by weather changes that cause MPP fluctuations. Weather-induced fluctuations in the MPP can result in the misreading of the optimal MPP value. The literature [31] proposed an open-circuit voltage reading system based on time. On the other hand, to calculate V_{oc} and I_{sc} , the panel must be disconnected from the load. This method causes the power to disappear for a moment. To solve this problem, the literature [32] proposed the PV pilot to calculate V_{oc} without disconnecting the PV panel. The proposed schematic is shown in Fig. 4. Another way to overcome this is [33–35] by proposing a circuit to sample the voltage and current of the solar panel by shortening the reading time. Similarly, literature [36, 37] added a simple analogue feed forward PWM controller to track

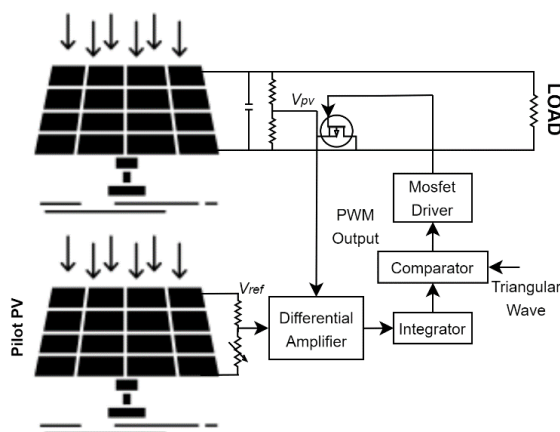

Fig. 4. PV pilot concept

the MPP by automatically adjusting the reference voltage. Literature [37] proposed a semi-pilot PV which has two functions: the first as a supply to the load, and the second as a pilot PV for measuring open-circuit voltage. However, the disadvantages of the method of adding other devices, such as the PV pilot, make it more expensive.

3.1.2. Temperature parametric

The dependence of the current generated by the PV module due to the irradiation effect and the PV module voltage due to the temperature effect provided the basis for the development of this method [54–57]. This method allows direct MPP prediction with Eq. (3), which can achieve linearization of the optimal voltage, cell junction temperature, and solar irradiation. This method is performed by estimating irradiation and measuring temperature to determine MPP. The flowchart and block diagram of this method are shown in Fig. 5. In this method, the optimal stress is obtained through the formula as:

$$V_{mpp} \cong (u + S_v) - T (w + S_y), \quad (3)$$

where: u , v , w and y are the PV parameters at different irradiance conditions S in W/m^2 , while T is the actual temperature.

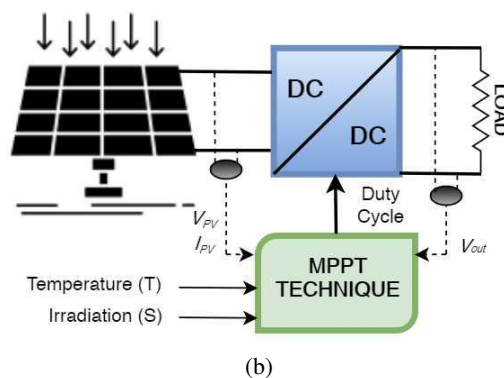
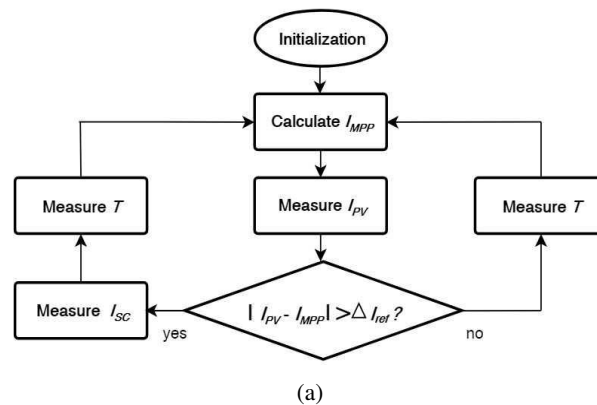

Fig. 5. Parametric temperature methods: (a) flowchart and (b) block diagrams

The temperature parametric method modification is done by literature [38] based on the 3D linear regression model. The linear regression used allows this method to be carried out in real-time to track MPP. Each PV module does not have the same optimal voltage for the same temperature and solar irradiation. Thus, the first step is to choose three different types of PV modules and then know their characteristics. Furthermore, a 3-dimensional linear correlation between the optimal voltage V_{mpp} , ambient temperature T and solar irradiation S was found by Matlab and P-SIM. The behavior of V_{mpp} was studied towards different temperatures and solar irradiation for several PV modules, so it was found

$$V_{mpp} = \alpha_0 + \alpha_1 S + \alpha_2 T, \tag{4}$$

where α_0 , α_1 and α_2 are constants which are determined depending on the PV module used. After the coefficients α_0 , α_1 and α_2 are determined, V_{mpp} can be found in real-time by measuring the ambient temperature and solar irradiation with Eq. (4). The algorithm method proposed by the literature is shown in Fig. 6.

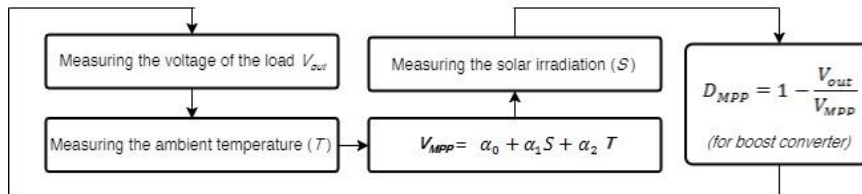

Fig. 6. Improved temperature parametric algorithm

3.1.3. Voltage/current feedback

This method is commonly used in stand-alone PV systems that do not use batteries. Figure 7 shows a basic diagram of the voltage/current feedback method. This method consists of a simple control system to tie the voltage or current to a constant level [58]. In this method, the duty cycle (D) of the DC–DC converter to control the PV at the specified operating point is adjusted by the error between the PV voltage or current and the PV constant voltage or current. This method is simple and uses only one feedback-loop control, making implementation economical. However, this method cannot handle variations in climatic conditions.

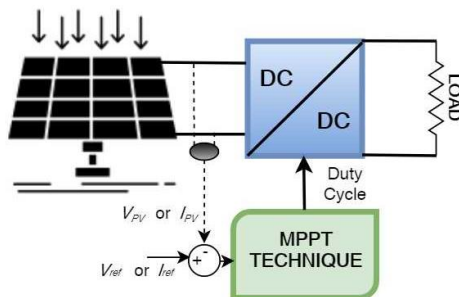

Fig. 7. Voltage/current feedback method

Literature [39] proposes an improvised current feedback technique in order to track the MPP under changing weather conditions. The proposed method adopts a PID control tuned by the relay tuning method. The schematic diagram of the proposed method is shown in Fig. 8. Relay tuning is used to make it easy and accurate to tune the PID parameters of systems that are not linear.

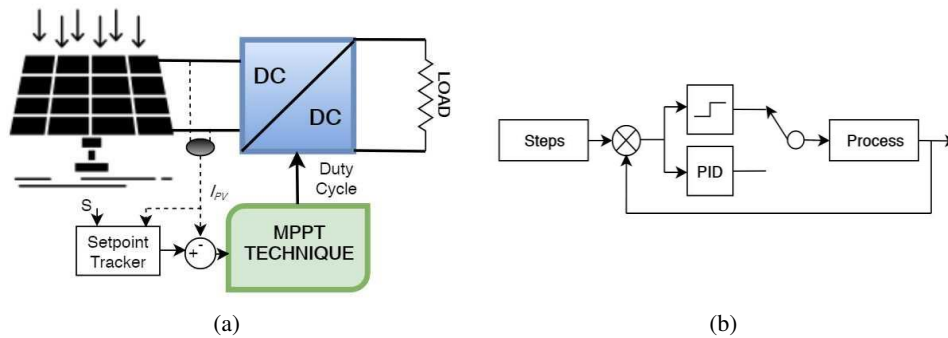

Fig. 8. Schematic of the current feedback method improvised with PID control: (a) diagram and (b) relay tuning method

Literature [40] proposes an MPPT controller with two sensors as feedback in a proportional-integral (P-I) closed loop. The maximum reference voltage of the PV panel is obtained by comparing the feedback voltage of the panel with the maximum reference PV voltage specified $V_{PV,ref}$. The output reference voltage ($V_{O,ref}$) is obtained from the error obtained by adjusting the P-I controller. The reference values obtained provide the maximum fixed output voltage reference for the DC-DC converter. The set reference voltage ($V_{O,ref}$) is compared with the feedback signal obtained from the DC load voltage to obtain an error signal. Then it is applied to the P-I controller to compensate for the available errors.

3.1.4. P-N junction drop voltage

This method is one of the old methods used to track the MPP. The irradiation effect is negligible in this method, and only the temperature effect is considered. The basic concept of this method is the relationship between the temperature characteristics of the PV cell and the voltage of the p-n junction diode [41]. The diode configuration is placed between the PV cell and the converter. The p-n junction voltage drop is used as the tracer reference voltage. This voltage drop is caused by changes in the surface temperature of the PV so that it affects the diode installed on the back of the PV panel. A simple schematic of this method is shown in Fig. 9.

The reference voltage, V_r , is given by

$$V_r = k_2 (V_s - V_{ref}) = k_2 (V_s - k_1 V_d), \quad (5)$$

where: V_d is the forward voltage drop of the p-n junction, V_{ref} is the reference voltage derived from the amplified value V_d , V_s is the output voltage of the PV module. Whereas k_1 and k_2 are the gains of the Amp1 and Amp2 amplifiers, respectively.

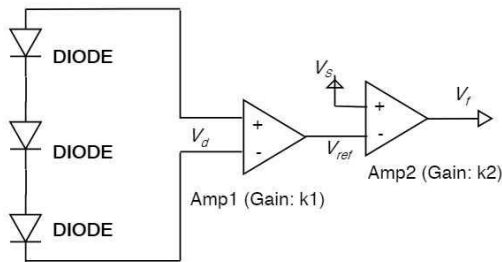

Fig. 9. Control circuit configuration based on constant voltage

3.2. Based on trial-and-error

These techniques seek to measure and interpret the results in order to decide whether to achieve the MPP. The basic description and related work of the MPPT techniques based on trial-and-error are summarized in Table 2, and the details are explained below.

Table 2. Basic description and related works to MPPT technique based on trial-and-error

MPPT technique	Description of the technique	Related works
Perturb and observe (P&O)	<ul style="list-style-type: none"> - The reference voltage perturbation technique has a faster response to irradiation changes and temperature transients but has low stability when operated at high disturbance levels. - The direct duty cycle perturbation technique provides better energy utilization with good stability. However, the response of this technique is slower in dealing with changes in irradiation and temperature. - Advantages: Does not require information on PV characteristics and can be applied to all PV modules. - Disadvantages: Tracking outcomes are strongly influenced by perturbation step size, especially in P&O with fixed step size perturbations. The magnitude of the step size value will affect the oscillation which is proportional to the step size itself. While the small step size value will affect the speed of the system in finding MPP. 	<ul style="list-style-type: none"> - Killi and Samanta [29] and Ahmed and Salam [66] propose an improvisation of conventional P&O algorithms to reduce steady-state oscillations and eliminate the possibility of divergence from the MPP locus. Divergence is a drift in the direction of the MPP search which usually occurs in P&O algorithms due to changes in irradiation. - Jusoh <i>et al.</i> propose variable step-size perturbation [67] to reduce the oscillations that occur in conventional P&O. - Alik and Jusoh [68] proposed modification of P&O by checking algorithm. This modification has a varying step size resulting in a faster tracking speed.

Continued on next page

Table 2 [cont.]

MPPT technique	Description of the technique	Related works
DC-link capacitor drop	<ul style="list-style-type: none"> – This method is designed to work with PV systems connected in parallel with AC system lines by detecting the voltage drop across the DC link capacitor [69–71]. – Advantages: Simple, requires no detection or power calculation and no decision logic or lookup tables. – Disadvantages: slow convergence, only designed for AC systems, system response and stability are highly dependent on the main circuit and its control system parameters. 	<ul style="list-style-type: none"> – Ding <i>et al.</i> [72] proposed an adaptive DC-link voltage control method for two-stage PV inverters during low voltage ride-through (LVRT) operation period. The DC-link voltage is controlled following changes in network voltage during LVRT operation to maintain a high modulation ratio.
Variable Inductance	<ul style="list-style-type: none"> – The constant inductor in the buck converter is replaced by a variable inductor. – Advantage: reduces inductor size by 75% [73]. – Disadvantage: Slow convergence. 	<ul style="list-style-type: none"> – Costa <i>et al.</i> [74] used a DC–DC LLC resonant converter which made the system more complex. However, the resulting performance decreases the overall losses in the converter. In addition, the transformer allows galvanic isolation from the input to the output.

3.2.1. Perturb and observe (P&O)

Perturb and observe (P&O) [59–64] is the method most widely used by researchers, even for commercial production. For researchers, this method is a favorite to be used as a comparison of the other methods they have developed. The flowchart of the conventional P&O method is shown in Fig. 10. Broadly speaking, the P&O method can be implemented into two techniques, namely reference voltage perturbation and direct duty ratio perturbation. The reference voltage perturbation technique has a faster response to handle radiation changes and temperature transients but has low stability when operated at high perturbation rates. On the other hand, the direct duty cycle perturbation technique results in better energy utilization with good stability. But this method is slower to respond to changes in the amount of light and the temperature [65].

At the reference voltage perturbation, the PV output voltage is perturbed periodically and the output power is compared to the previous cycle. The perturbation position in the P&O algorithm is shown in Fig. 11. It can be seen that, in simple terms, perturbation to the right is performed when the PV operating point is on the left, and vice versa. The advantage of this method is that it does not require information on PV characteristics and can be applied to all PV modules. However, the weakness of this method is that the tracking results are strongly influenced by the step-size of perturbation, especially in P&O with fixed step-size perturbation. The large step-size value will have an effect on the oscillation that is proportional to the step-size itself. Meanwhile, the small step-size value will affect the system speed in finding MPP.

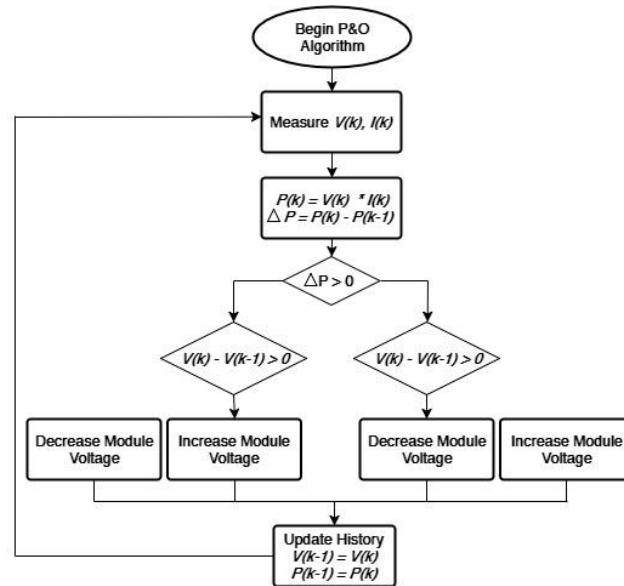

Fig. 10. Flowchart P&O

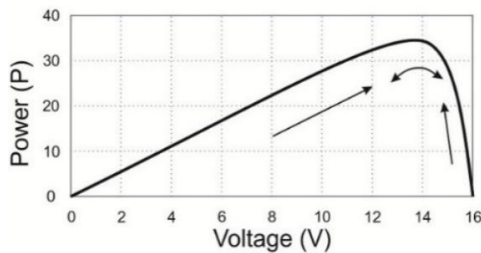
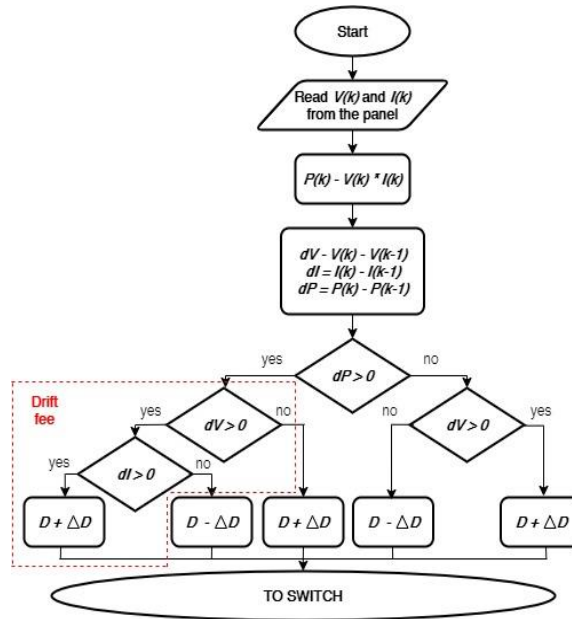
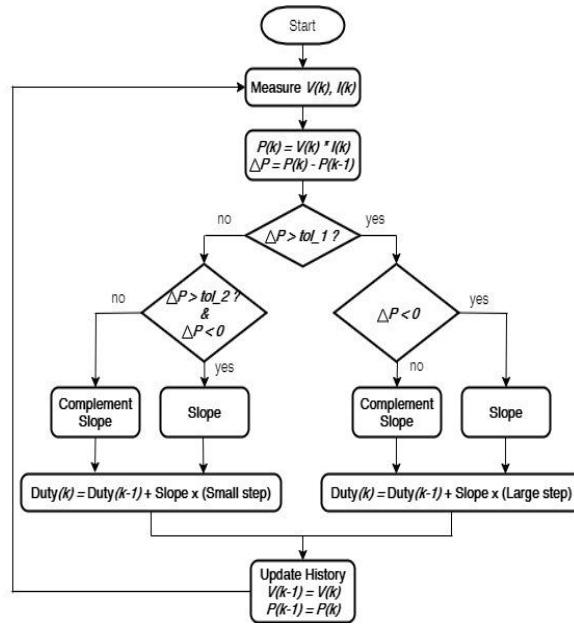

Fig. 11. Power versus voltage graph in the P&O perturbation algorithm

Various studies were conducted to develop the P&O algorithm. Killi and Samanta [29], as well as Ahmed and Salam [66], propose improvisation of the conventional P&O algorithm in order to eliminate the possibility of divergence from the MPP locus and reduce steady-state oscillations. Divergence is a drift in the direction of the MPP search that usually occurs in the P&O algorithm due to changes in irradiation. The scheme proposed by the literature is shown in Fig. 12(a). In the literature [67], variable step-size perturbation was also used to reduce the oscillations that occur in conventional P&O. The schematic proposed in the literature is shown with a flowchart in Fig. 12(b). In that study, if the perturbation goes to MPP, the duty cycle is increased by the multiplication factor (A) i.e., $\Delta P > 0$. However, if $\Delta P < 0$, then the duty cycle must be divided by (A). Factor (A) is a constant whose value is greater than 1. Changes to the P&O algorithm were also made by [68], which suggested a checking algorithm.



(a)



(b)

Fig. 12. Flowchart systems are proposed by: (a) literature [29] to eliminate drift and (b) by [67] to reduce oscillations

3.2.2. DC-link capacitor drop

The diagram of this method is shown in Fig. 13. This method is designed to work with a PV system connected in parallel with an AC system line by detecting the voltage drop across the DC link capacitor [69–71]. The duty ratio boost converter is obtained by the equation:

$$D = 1 - \frac{V_{pv}}{V_{link}}, \tag{6}$$

where V_{link} is the boost converter output voltage, and V_{pv} is the input voltage. The power that comes out of the boost converter can be increased by increasing the current entering the inverter, thereby increasing the power output from the PV module. The V_{link} voltage can be kept constant in a range that does not exceed the maximum power of the PV module. Capacitor V_{link} starts dropping when it exceeds PV power. Before the dropping point, the inverter current control command is at the maximum position, and the PV module operates on the MPP. To prevent V_{link} dropping, the AC system line current is fed back to the DC link.

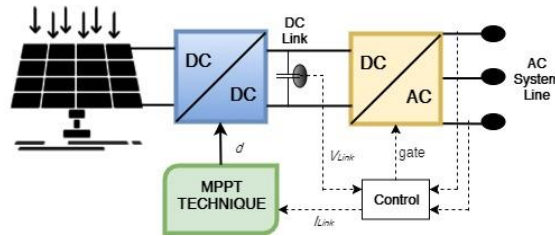

Fig. 13. DC-link capacitor drops control method diagram

Literature [72] proposes an adaptive DC-link voltage control method for two-stage PV inverters during the low voltage ride-through (LVRT) operation period. The DC-link voltage is controlled following the changes in network voltage during LVRT operation to maintain a high modulation ratio. Therefore, the high-frequency harmonics injected into the network can be reduced. The proposed control method can reduce the double-line-frequency DC-link voltage ripple within a certain limit. This ripple reduction can keep the DC-link voltage within a safe operational range. Front-end converter control aims to change according to the DC-link voltage reference.

3.2.3. Variable inductance

Figure 14 shows the variable inductance control schematic diagram. In this method, the constant inductor in the buck converter is replaced by a variable inductor. The advantage of this replacement is that it can reduce the inductor size by up to 75% [73]. In another work, literature [74] used DC–DC LLC resonant converters. The low inductance value is sufficient to overcome the high irradiation case. Meanwhile, the inductance should be increased in the case of low irradiation. The minimum inductance is given by

$$L_{min} = \frac{D^2(1 - D)V_{pv}}{2f_s I_{pv}}, \tag{7}$$

where f_s is the switching frequency.

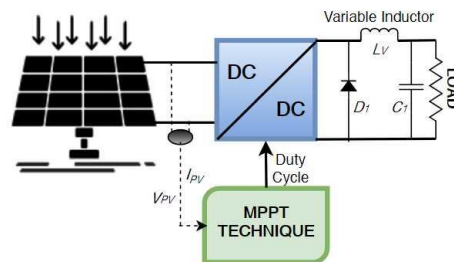

Fig. 14. Variable inductance method diagram

4. Conclusion

Many academics have been working on a variety of MPPT strategies to increase the power output of PV-based power plants in an effort to contribute to the development of sustainable renewable energy sources such as solar and wind. An overview of MPPT approaches and their modifications classified according to constant parameters and trial-and-error has been offered in this Part I in the form of a review of the literature. A table has also been created to present the basic concepts of the method, advantages and disadvantages, and highlight the most recent changes in the modification of each algorithm in a thorough manner. This review can be quite valuable when picking MPPT solutions that are minimal in cost and can be deployed quickly.

Acknowledgements

This research was financed by the Ministry of Education, Culture, Research, and Technology, Indonesia, via a World Class Research (WCR) Scheme under Contract No. 002/SKP.TT.PD/LPPM/IV/2021.

References

- [1] Ram J.P., Babu T.S., Rajasekar N., *A comprehensive review on solar PV maximum power point tracking techniques*, Renewable and Sustainable Energy Reviews, vol. 67, pp. 826–847 (2017), DOI: [10.1016/j.rser.2016.09.076](https://doi.org/10.1016/j.rser.2016.09.076).
- [2] Pallavee Bhatnagar A., Nema B.R.K., *Conventional and global maximum power point tracking techniques in photovoltaic applications: A review*, Journal of Renewable and Sustainable Energy, vol. 5, no. 3, p. 2701 (2013), DOI: [10.1063/1.4803524](https://doi.org/10.1063/1.4803524).
- [3] Sutikno T., Subrata A.C., Elkhateb A., *Evaluation of Fuzzy Membership Function Effects for Maximum Power Point Tracking Technique of Photovoltaic System*, IEEE Access, p. 1 (2021), DOI: [10.1109/ACCESS.2021.3102050](https://doi.org/10.1109/ACCESS.2021.3102050).
- [4] Hafiz A.M., Abdelrahman M.E., Temraz H., *Economic dispatch in power system networks including renewable energy resources using various optimization techniques*, Archives of Electrical Engineering, vol. 70, no. 3, pp. 643–655 (2021), DOI: [10.24425/ae.2021.137579](https://doi.org/10.24425/ae.2021.137579).
- [5] Solangi K.H., Islam M.R., Saidur R., Rahim N.A., Fayaz H., *A review on global solar energy policy*, Renewable and Sustainable Energy Reviews, vol. 15, no. 4, pp. 2149–2163 (2011), DOI: [10.1016/j.rser.2011.01.007](https://doi.org/10.1016/j.rser.2011.01.007).

- [6] Tsoutsos T., Frantzeskaki N., Gekas V., *Environmental impacts from the solar energy technologies*, Energy Policy, vol. 33, no. 3, pp. 289–296 (2005), DOI: [10.1016/S0301-4215\(03\)00241-6](https://doi.org/10.1016/S0301-4215(03)00241-6).
- [7] Wang Q., Qiu H.-N., *Situation and outlook of solar energy utilization in Tibet, China*, Renewable and Sustainable Energy Reviews, vol. 13, no. 8, pp. 2181–2186 (2009), DOI: [10.1016/j.rser.2009.03.011](https://doi.org/10.1016/j.rser.2009.03.011).
- [8] Saidur R., Islam M.R., Rahim N.A., Solangi K.H., *A review on global wind energy policy*, Renewable and Sustainable Energy Reviews, vol. 14, no. 7, pp. 1744–1762 (2010), DOI: [10.1016/j.rser.2010.03.007](https://doi.org/10.1016/j.rser.2010.03.007).
- [9] Liserre M., Sauter T., Hung J.Y., *Future energy systems: Integrating renewable energy sources into the smart power grid through industrial electronics*, IEEE Industrial Electronics Magazine, vol. 4, no. 1, pp. 18–37 (2010), DOI: [10.1109/MIE.2010.935861](https://doi.org/10.1109/MIE.2010.935861).
- [10] Mohapatra A., Nayak B., Das P., Mohanty K.B., *A review on MPPT techniques of PV system under partial shading condition*, Renewable and Sustainable Energy Reviews, vol. 80, pp. 854–867 (2017), DOI: [10.1016/j.rser.2017.05.083](https://doi.org/10.1016/j.rser.2017.05.083).
- [11] Seyedmahmoudian M., Horan B., Soon T.K., Rahmani R., Than Oo A.M., Mekhilef S. *et al.*, *State of the art artificial intelligence-based MPPT techniques for mitigating partial shading effects on PV systems – A review*, Renewable and Sustainable Energy Reviews, vol. 64, pp. 435–455 (2016), DOI: [10.1016/j.rser.2016.06.053](https://doi.org/10.1016/j.rser.2016.06.053).
- [12] Yang B., Zhu T., Wang J., Shu H., Yu T., Zhang X. *et al.*, *Comprehensive overview of maximum power point tracking algorithms of PV systems under partial shading condition*, Journal of Cleaner Production, p. 121983 (2020), DOI: [10.1016/j.jclepro.2020.121983](https://doi.org/10.1016/j.jclepro.2020.121983).
- [13] Subudhi B., Pradhan R., *A comparative study on maximum power point tracking techniques for photovoltaic power systems*, IEEE Transactions on Sustainable Energy, vol. 4, no. 1, pp. 89–98 (2012), DOI: [10.1109/TSTE.2012.2202294](https://doi.org/10.1109/TSTE.2012.2202294).
- [14] Salam Z., Ahmed J., Merugu B.S., *The application of soft computing methods for MPPT of PV system: A technological and status review*, Applied Energy, vol. 107, pp. 135–148 (2013), DOI: [10.1016/j.apenergy.2013.02.008](https://doi.org/10.1016/j.apenergy.2013.02.008).
- [15] Seddjar A., Kerrouche K.D.E., Wang L., *Simulation of the proposed combined Fuzzy Logic Control for Maximum Power Point Tracking and Battery Charge Regulation used in CubeSat*, Archives of Electrical Engineering, vol. 69, no. 3, pp. 521–543 (2020), DOI: [10.24425/aee.2020.133916](https://doi.org/10.24425/aee.2020.133916).
- [16] Verma D., Nema S., Shandilya A.M., Dash S.K., *Maximum power point tracking (MPPT) techniques: Recapitulation in solar photovoltaic systems*, Renewable and Sustainable Energy Reviews, vol. 54, pp. 1018–1034 (2016), DOI: [10.1016/j.rser.2015.10.068](https://doi.org/10.1016/j.rser.2015.10.068).
- [17] Esram T., Chapman P.L., *Comparison of photovoltaic array maximum power point tracking techniques*, IEEE Transactions on Energy Conversion, vol. 22, no. 2, pp. 439–449 (2007), DOI: [10.1109/TEC.2006.874230](https://doi.org/10.1109/TEC.2006.874230).
- [18] Ali A.N.A., Saied M.H., Mostafa M.Z., Abdel-Moneim T.M., *A survey of maximum PPT techniques of PV systems*, IEEE Energytech, pp. 1–17 (2012), DOI: [10.1109/EnergyTech.2012.6304652](https://doi.org/10.1109/EnergyTech.2012.6304652).
- [19] Kamarzaman N.A., Tan C.W., *A comprehensive review of maximum power point tracking algorithms for photovoltaic systems*, Renewable and Sustainable Energy Reviews, vol. 37, pp. 585–598 (2014), DOI: [10.1016/j.rser.2014.05.045](https://doi.org/10.1016/j.rser.2014.05.045).
- [20] Bendib B., Belmili H., Krim F., *A survey of the most used MPPT methods: Conventional and advanced algorithms applied for photovoltaic systems*, Renewable and Sustainable Energy Reviews, vol. 45, pp. 637–648 (2015), DOI: [10.1016/j.rser.2015.02.009](https://doi.org/10.1016/j.rser.2015.02.009).
- [21] Gupta A., Chauhan Y.K., Pachauri R.K., *A comparative investigation of maximum power point tracking methods for solar PV system*, Solar Energy, vol. 136, pp. 236–253 (2016), DOI: [10.1016/j.solener.2016.07.001](https://doi.org/10.1016/j.solener.2016.07.001).

- [22] Podder A.K., Roy N.K., Pota H.R., *MPPT methods for solar PV systems: a critical review based on tracking nature*, IET Renewable Power Generation, vol. 13, no. 10, pp. 1615–1632 (2019), DOI: [10.1049/iet-rpg.2018.5946](https://doi.org/10.1049/iet-rpg.2018.5946).
- [23] Tajuddin M.F.N., Arif M.S., Ayob S.M., Salam Z., *Perturbative methods for maximum power point tracking (MPPT) of photovoltaic (PV) systems: a review*, International Journal of Energy Research, vol. 39, no. 9, pp. 1153–1178 (2015), DOI: [10.1049/iet-rpg.2019.1163](https://doi.org/10.1049/iet-rpg.2019.1163).
- [24] Danandeh M.A., Mousavi G.S.M., *Comparative and comprehensive review of maximum power point tracking methods for PV cells*, Renewable and Sustainable Energy Reviews, vol. 82, pp. 2743–2267 (2018), DOI: [10.1016/j.rser.2017.10.009](https://doi.org/10.1016/j.rser.2017.10.009).
- [25] Bollipo R.B., Mikkili S., Bonthagorla P.K., *Critical Review on PV MPPT Techniques: Classical, Intelligent and Optimisation*, IET Renewable Power Generation, vol. 19, no. 9, pp. 1433–1452 (2020), DOI: [10.1049/iet-rpg.2019.1163](https://doi.org/10.1049/iet-rpg.2019.1163).
- [26] Karami N., Moubayed N., Outbib R., *General review and classification of different MPPT Techniques*, Renewable and Sustainable Energy Reviews, vol. 68, pp. 1–18 (2017), DOI: [10.1016/j.rser.2016.09.132](https://doi.org/10.1016/j.rser.2016.09.132).
- [27] Mao M., Cui L., Zhang Q., Guo K., Zhou L., Huang H., *Classification and summarization of solar photovoltaic MPPT techniques: A review based on traditional and intelligent control strategies*, Energy Reports, vol. 6, pp. 1312–1327 (2020), DOI: [10.1016/j.egypr.2020.05.013](https://doi.org/10.1016/j.egypr.2020.05.013).
- [28] Zhang B., Hong D., Wang T., Zhang Z., Wang D., *A novel two-phase interleaved parallel bi-directional DC/DC converter*, Archives of Electrical Engineering, vol. 70, no. 1, pp. 219–231 (2021), DOI: [10.24425/ae.2021.136063](https://doi.org/10.24425/ae.2021.136063).
- [29] Killi M., Samanta S., *Modified perturb and observe MPPT algorithm for drift avoidance in photovoltaic systems*, IEEE Transactions on Industrial Electronics, vol. 62, no. 9, pp. 5549–5559 (2015), DOI: [10.1109/TIE.2015.2407854](https://doi.org/10.1109/TIE.2015.2407854).
- [30] Masoum M.A.S., Dehbonei H., Fuchs E.F., *Theoretical and experimental analyses of photovoltaic systems with voltage and current-based maximum power-point tracking*, IEEE Transactions on Energy Conversion, vol. 17, no. 4, pp. 514–522 (2002), DOI: [10.1109/TEC.2002.805205](https://doi.org/10.1109/TEC.2002.805205).
- [31] Bharath K.R., Suresh E., *Design and implementation of improved fractional open circuit voltage based maximum power point tracking algorithm for photovoltaic applications*, International Journal of Renewable Energy Research, vol. 7, no. 3, pp. 1108–1113 (2017), DOI: [10.20508/ijrer.v7i3.5899.g7141](https://doi.org/10.20508/ijrer.v7i3.5899.g7141).
- [32] Leedy A.W., Guo L., Aganah K.A., *A constant voltage MPPT method for a solar powered boost converter with DC motor load*, Proceedings of IEEE Southeastcon, pp. 1–6 (2012), DOI: [10.1109/SECon.2012.6196885](https://doi.org/10.1109/SECon.2012.6196885).
- [33] Ahmad J., *A fractional open circuit voltage based maximum power point tracker for photovoltaic arrays*, 2010 2nd International Conference on Software Technology and Engineering, vol. 1, pp. V1-247 (2010), DOI: [10.1109/ICSTE.2010.5608868](https://doi.org/10.1109/ICSTE.2010.5608868).
- [34] Das P., *Maximum power tracking based open circuit voltage method for PV system*, Energy Procedia, vol. 90, pp. 2–13 (2016), DOI: [10.1016/j.egypro.2016.11.165](https://doi.org/10.1016/j.egypro.2016.11.165).
- [35] Sher H.A., Murtaza A.F., Noman A., Addoweesh K.E., Chiaberge M., *An intelligent control strategy of fractional short circuit current maximum power point tracking technique for photovoltaic applications*, Journal of Renewable and Sustainable Energy, vol. 7, no. 1, p. 13114 (2015), DOI: [10.1063/1.4906982](https://doi.org/10.1063/1.4906982).
- [36] Asim M., Tariq M., Mallick M.A., Ashraf I., *An improved constant voltage based MPPT technique for PMDC motor*, International Journal of Power Electronics and Drive Systems, vol. 7, no. 4 (2016), DOI: [10.11591/ijpeds.v7i4.pp1330-1336](https://doi.org/10.11591/ijpeds.v7i4.pp1330-1336).
- [37] Baimel D., Tapuchi S., Levron Y., Belikov J., *Improved fractional open circuit voltage mppt methods for pv systems*, Electronics, vol. 8, no. 3, p. 321 (2019), DOI: [10.3390/electronics8030321](https://doi.org/10.3390/electronics8030321).

- [38] El Mentaly L., Amghar A., Sahsa H., *Improvement of the Temperature Parametric (TP) Method for Fast Tracking of Maximum Power Point in Photovoltaic Modules*, International Journal of Electrical Power and Energy Systems, vol. 20, no. 5 (2019), DOI: [10.1515/ijeeps-2018-0311](https://doi.org/10.1515/ijeeps-2018-0311).
- [39] Karanjkar D.S., Chatterji S., Shimi S.L., Kumar A., *An improved current feedback based maximum power point tracking controller for solar photo-voltaic system*, Annual International Conference on Emerging Research Areas and 2013 International Conference on Microelectronics, Communications and Renewable Energy, pp. 1–6 (2013), DOI: [10.1109/AICERA-ICMiCR.2013.6576032](https://doi.org/10.1109/AICERA-ICMiCR.2013.6576032).
- [40] Sanjeevikumar P., Grandi G., Wheeler P.W., Blaabjerg F., Loncarski J., *A simple MPPT algorithm for novel PV power generation system by high output voltage DC–DC boost converter*, 2015 IEEE 24th International Symposium on Industrial Electronics (ISIE), pp. 214–220 (2015), DOI: [10.1109/ISIE.2015.7281471](https://doi.org/10.1109/ISIE.2015.7281471).
- [41] Kobayashi K., Matsuo H., Sekine Y., *An excellent operating point tracker of the solar-cell power supply system*, IEEE Transactions on Industrial Electronics, vol. 53, no. 2, pp. 495–499 (2006), DOI: [10.1109/tie.2006.870669](https://doi.org/10.1109/tie.2006.870669).
- [42] Huang Y.-P., Hsu S.-Y., *A performance evaluation model of a high concentration photovoltaic module with a fractional open circuit voltage-based maximum power point tracking algorithm*, Computers and Electrical Engineering, vol. 51, pp. 331–342 (2016), DOI: [10.1016/j.compeleceng.2016.01.009](https://doi.org/10.1016/j.compeleceng.2016.01.009).
- [43] Hsu T.-W., Wu H.-H., Tsai D.-L., Wei C.-L., *Photovoltaic energy harvester with fractional open-circuit voltage based maximum power point tracking circuit*, IEEE Transactions on Circuits and Systems II: Express Briefs, vol. 66, no. 2, pp. 257–261 (2018), DOI: [10.1109/TCSII.2018.2838672](https://doi.org/10.1109/TCSII.2018.2838672).
- [44] Ankaiah B., Nageswararao J., *Enhancement of Solar Photovoltaic Cell by Using Short-Circuit Current MPPT Method*, International Journal of Science and Engineering Invention, vol. 2, no. 2, pp. 45–50 (2013).
- [45] Kumari J.S., Babu C.S., Yugandhar J., *Design and investigation of short circuit current based maximum power point tracking for photovoltaic system*, International Journal of Electrical and Computer Engineering, vol. 1 (2011).
- [46] Sandali A., Oukhoya T., Cheriti A., *Modeling and design of PV grid connected system using a modified fractional short-circuit current MPPT*, International Renewable and Sustainable Energy Conference, 2014, p. 224–9 (2014), DOI: [10.1109/IRSEC.2014.7059859](https://doi.org/10.1109/IRSEC.2014.7059859).
- [47] Kumar R., Sahu B., Shiva C.K., Rajender B., *A control topology for frequency regulation capability in a grid integrated PV system*, Archives of Electrical Engineering, vol. 69, no. 2, pp. 389–401 (2020), DOI: [10.24425/ae.2020.133033](https://doi.org/10.24425/ae.2020.133033).
- [48] Subudhi B., Pradhan R., *Characteristics evaluation and parameter extraction of a solar array based on experimental analysis*, 2011 IEEE Ninth International Conference on Power Electronics and Drive Systems, pp. 340–344 (2011), DOI: [10.1109/PEDS.2011.6147269](https://doi.org/10.1109/PEDS.2011.6147269).
- [49] Waszynczuk O., *Dynamic behavior of a class of photovoltaic power systems*, IEEE Transactions on Power Apparatus and Systems, no. 9, pp. 3031–3037 (1983), DOI: [10.1109/TPAS.1983.318109](https://doi.org/10.1109/TPAS.1983.318109).
- [50] Shimizu T., Hashimoto O., Kimura G., *A novel high-performance utility-interactive photovoltaic inverter system*, IEEE Transactions on Power Electronics, vol. 18, no. 2, pp. 704–11 (2003), DOI: [10.1109/TPEL.2003.809375](https://doi.org/10.1109/TPEL.2003.809375).
- [51] Koutroulis E., Kalaitzakis K., Voulgaris N.C., *Development of a microcontroller-based, photovoltaic maximum power point tracking control system*, IEEE Transactions on Power Electronics, vol. 16, no. 1, pp. 46–54 (2001), DOI: [10.1109/63.903988](https://doi.org/10.1109/63.903988).
- [52] Veerachary M., Senjyu T., Uezato K., *Maximum power point tracking control of IDB converter supplied PV system*, IEE Proceedings - Electric Power Applications, vol. 148, no. 6, pp. 494–502 (2001), DOI: [10.1049/ip-epa:20010656](https://doi.org/10.1049/ip-epa:20010656).

- [53] Xiao W., Dunford W.G., *A modified adaptive hill climbing MPPT method for photovoltaic power systems*, 2004 IEEE 35th Annual Power Electronics Specialists Conference, vol. 3, pp. 1957–1963 (2004), DOI: [10.1109/PESC.2004.1355417](https://doi.org/10.1109/PESC.2004.1355417).
- [54] Vicente E.M., dos Santos Vicente P., Moreno R.L., Ribeiro E.R., *High-efficiency MPPT method based on irradiance and temperature measurements*, IET Renewable Power Generation, vol. 14, no. 3, pp. 986–995 (2020), DOI: [1049/iet-rpg.2019.0849](https://doi.org/10.1049/iet-rpg.2019.0849).
- [55] El Mentaly L., Amghar A., Sahsah H., *Comparison between Seven MPPT Techniques Implemented in a Buck Converter*, Recent Advances in Electrical and Electronic Engineering, vol. 12, no. 6, pp. 476–486 (2019), DOI: [10.2174/2352096511666180705113647](https://doi.org/10.2174/2352096511666180705113647).
- [56] Park M., Yu I.-K., *A study on the optimal voltage for MPPT obtained by surface temperature of solar cell*, 30th Annual Conference of IEEE Industrial Electronics Society, vol. 3, pp. 2040–2045 (2004), DOI: [10.1109/IECON.2004.1432110](https://doi.org/10.1109/IECON.2004.1432110).
- [57] Faranda R., Leva S., Maugeri V., *MPPT techniques for PV systems: Energetic and cost comparison*, 2008 IEEE Power and Energy Society General Meeting, pp. 1–6 (2008), DOI: [10.1109/PES.2008.4596156](https://doi.org/10.1109/PES.2008.4596156).
- [58] Fernández H., Martínez A., Guzmán V., Gímenez M.I., *A simple, low cost design using current feedback to improve the efficiency of a MPPT-PV system for isolated locations*, 2008 13th International Power Electronics and Motion Control Conference, pp. 1947–50 (2008), DOI: [10.1109/EPEPEMC.2008.4635550](https://doi.org/10.1109/EPEPEMC.2008.4635550).
- [59] Femia N., Petrone G., Spagnuolo G., Vitelli M., *Optimization of perturb and observe maximum power point tracking method*, IEEE Transactions on Power Electronics, vol. 20, no. 4, pp. 963–973 (2005), DOI: [10.1109/TPEL.2005.850975](https://doi.org/10.1109/TPEL.2005.850975).
- [60] Wolfs P.J., Tang L., *A single cell maximum power point tracking converter without a current sensor for high performance vehicle solar arrays*, 2005 IEEE 36th Power Electronics Specialists Conference, pp. 165–71 (2005), DOI: [10.1109/PESC.2005.1581619](https://doi.org/10.1109/PESC.2005.1581619).
- [61] D'Souza N.S., Lopes L.A.C., Liu X., *An intelligent maximum power point tracker using peak current control*, 2005 IEEE 36th Power Electronics Specialists Conference, p. 172 (2005), DOI: [10.1109/PESC.2005.1581620](https://doi.org/10.1109/PESC.2005.1581620).
- [62] Pandey A., Dasgupta N., Mukerjee A.K., *High-performance algorithms for drift avoidance and fast tracking in solar MPPT system*, IEEE Transactions on Energy Conversion, vol. 23, no. 2, pp. 681–689 (2008), DOI: [10.1109/TEC.2007.914201](https://doi.org/10.1109/TEC.2007.914201).
- [63] Sefa I., Özdemir Ş., *Experimental study of interleaved MPPT converter for PV systems*, 35th Annual Conference of IEEE Industrial Electronics, pp. 456–461 (2009), DOI: [10.1109/IECON.2009.5414965](https://doi.org/10.1109/IECON.2009.5414965).
- [64] Hua C., Lin J.R., *DSP-based controller application in battery storage of photovoltaic system*, Proceedings of the 1996 IEEE IECON, 22nd International Conference on Industrial Electronics, Control, and Instrumentation, vol. 3, pp. 1705–1710 (1996), DOI: [10.1109/IECON.1996.570673](https://doi.org/10.1109/IECON.1996.570673).
- [65] Elgendy M.A., Zahawi B., Atkinson D.J., *Assessment of perturb and observe MPPT algorithm implementation techniques for PV pumping applications*, IEEE Transactions on Sustainable Energy, vol. 3, no. 1, pp. 21–33 (2011), DOI: [10.1109/TSTE.2011.2168245](https://doi.org/10.1109/TSTE.2011.2168245).
- [66] Ahmed J., Salam Z., *An improved perturb and observe (P&O) maximum power point tracking (MPPT) algorithm for higher efficiency*, Applied Energy, vol. 150, pp. 97–108 (2015), DOI: [10.1016/j.apenergy.2015.04.006](https://doi.org/10.1016/j.apenergy.2015.04.006).
- [67] Jusoh A. Bin, Mohammed O.J.E.I., Sutikno T., *Variable step size Perturb and observe MPPT for PV solar applications*, Telkomnika, vol. 13, no. 1, p. 1 (2015), DOI: [10.12928/TELKOMNIKA.v13i1.1180](https://doi.org/10.12928/TELKOMNIKA.v13i1.1180).
- [68] Alik R., Jusoh A., *An enhanced P&O checking algorithm MPPT for high tracking efficiency of partially shaded PV module*, Solar Energy, vol. 163, pp. 570–580 (2018), DOI: [10.1016/j.solener.2017.12.050](https://doi.org/10.1016/j.solener.2017.12.050).

- [69] Lee J.-S., Lee K.B., *Variable DC-link voltage algorithm with a wide range of maximum power point tracking for a two-string PV system*, *Energies*, vol. 6, no. 1, pp. 58–78 (2013), DOI: [10.3390/en6010058](https://doi.org/10.3390/en6010058).
- [70] Matsui M., Kitano T., Xu D., Yang Z., *A new maximum photovoltaic power tracking control scheme based on power equilibrium at DC link*, *Conference Record of the 1999 IEEE Industry Applications Conference*, vol. 2, pp. 804–809 (1999), DOI: [10.1109/IAS.1999.801599](https://doi.org/10.1109/IAS.1999.801599).
- [71] Kitano T., Matsui M., Xu D., *Power sensor-less MPPT control scheme utilizing power balance at DC link-system design to ensure stability and response*, *IECON'01. 27th Annual Conference of the IEEE Industrial Electronics Society*, vol. 2, pp. 1309–1314 (2001), DOI: [1109/IECON.2001.975971](https://doi.org/10.1109/IECON.2001.975971).
- [72] Ding G., Gao F., Tian H., Ma C., Chen M., He G. *et al.*, *Adaptive DC-link voltage control of two-stage photovoltaic inverter during low voltage ride-through operation*, *IEEE Transactions on Power Electronics*, vol. 31, no. 6, pp. 4182–4194 (2015), DOI: [10.1109/TPEL.2015.2469603](https://doi.org/10.1109/TPEL.2015.2469603).
- [73] Zhang L., Hurley W.G., Wölflé W.H., *A new approach to achieve maximum power point tracking for PV system with a variable inductor*, *IEEE Transactions on Power Electronics*, vol. 26, no. 4, pp. 1031–1037 (2010), DOI: [10.1109/TPEL.2010.2089644](https://doi.org/10.1109/TPEL.2010.2089644).
- [74] Costa V.S., Perdigo M.S., Mendes A.S., Abbas D., Aitouche A., *Analysis and simulation of a LLC-VI resonant converter for solar applications*, *2017 52nd International Universities Power Engineering Conference*, pp. 1–6 (2017), DOI: [10.1109/UPEC.2017.8231962](https://doi.org/10.1109/UPEC.2017.8231962).