

THE INFLUENCE OF THE PROCESSING CONDITIONS ON CHANGES IN PHYSICAL AND STRUCTURAL PROPERTIES OF INJECTION MOULDED PARTS MADE OF POLYPROPYLENE

The injection moulding conditions may change the degree of crystallinity of the plastic to some extent, which affects the mechanical properties such as tensile strength and hardness. Moreover, the cooling conditions of the moulded parts may contribute to changes in their shrinkage. The paper presents the results of determination of the melting enthalpy of a polypropylene. The melting enthalpy ΔH_m was determined by differential scanning calorimetry. It was found, that the value of the melting enthalpy depends on the physical conditions prevailing during the sample production process, such as the temperature of the liquid material, the cooling rate of the plastic (related to the mould temperature T_m) and the flow rate of the plastic in the mould. The degree of crystallinity of the obtained samples was also determined, which, depending on the measured enthalpy of fusion, influences the degree of structural order of the polymer. Standardized test samples were also analysed in terms of transversal shrinkage and longitudinal shrinkage. The shrinkage of the injection moulded parts results from the change of physical state of plastic during its solidification in the mould.

Keywords: injection moulding; polypropylene; shrinkage; degree of crystallinity

1. Introduction

The plastic injection moulding process is widely used in the manufacturing of various products. The use of plastic parts in everyday life has increased significantly in recent decades. Injection moulding enables the formation of products of various shapes while maintaining excellent surface quality. The injection conditions and process parameters play a decisive role that affects the quality and efficiency of the production of plastic products. The most important injection moulding parameters are injection and mould temperature, injection time as well as holding time and pressure. Optimal process parameters not only reduce cycle time but also increase product quality [1,2]. In the work [3] it was shown that the rheological properties of the material and the processing conditions are of decisive importance for ensuring the complete filling of the mould cavity. The mould temperature was the factor that had the greatest impact on the size and crystallinity of the spherulite in PE-LD parts [4]. E. Farotti et al. [5] showed that the mould temperature and holding pressure are the factors determining the mechanical properties of moulded parts. Increases in temperature and injection speed can reduce the tensile strength and degree of crystallinity of

mouldings. On the other hand, the increase in mould temperature and injection pressure contribute to an increase in their tensile strength and the degree of crystallinity [6].

One of the few important aspects determining the quality of injection-moulded parts is processing shrinkage, which is the reduction in the volume of the part due to material behaviour. Dimensional contractions are assessed simultaneously in the transversal and longitudinal directions. Processing parameters, material and mould design are among many factors that may affect shrinkage [2,7-9]. In the work [10] it was shown that the location of the cooling channels has a large impact on the cooling process of the plastic product and the distribution of the shrinkage rate in the entire moulded part. The shrinkage value can be effectively influenced if the injection conditions are properly selected, within the processing capacity of the injection moulding machine, which was demonstrated by the analysis of injection shrinkage carried out by the authors in [11]. Both the addition or increase of the filler content in the polymer material and the extension of the injection and cooling times can lead to a reduction in injection shrinkage and, consequently, to an increase in the dimensional accuracy of the moulded part. Semi-crystalline materials have higher shrinkage values than amorphous ones.

¹ CZESTOCHOWA UNIVERSITY OF TECHNOLOGY, FACULTY OF MECHANICAL ENGINEERING AND COMPUTER SCIENCE, DEPARTMENT OF TECHNOLOGY AND AUTOMATION, 19C ARMII KRAJOWEJ AV., 42-201 CZESTOCHOWA, POLAND

* Corresponding author: pawel.palutkiewicz@pep.pl



The dimensions of injection-moulded parts made of semi-crystalline materials decrease over time after the moulding process. Post-moulding shrinkage is an effect of secondary crystallization, and an increase in the degree of polymer crystallinity leads to an increase in stiffness and a decrease in the impact strength of plastics [12]. The shrinkage of the material continues after the part has been moulded, because polymer particles can change the order of its structures even at room temperature [13]. Generally, the injection moulded part shrinkage depends on molecular arrangement after mould cavity filling and the phenomena occurring later, like cooling, crystallinity development and stress release [14].

Computer simulation processes are often performed to minimize and understand the relationship between plastic injection moulding parameters and part shrinkage [15]. In the calculations of plastic shrinkage the p-v-T model plays the dominant role [16]. It was shown in works [17-19], that for polypropylene the most important process parameter influencing shrinkage is the holding pressure, then the injection temperature and the mould temperature. The cooling time and the holding time have the least influence on the shrinkage value. As the mould temperature and (simultaneously) cooling time increases, the shrinkage value increases, with the amount of the injected material, crystallinity and orientation of the material having the greatest impact on it. The holding pressure was identified as the main factor of shrinkage value in the case of polyoxymethylene, which is, like polypropylene, a semi-crystalline polymer [20]. One of the most common reasons for warping of plastic components is due to shrinkage changes during the injection process [21]. The authors in [22] showed that the effect of processing conditions on shrinkage is different than on warping. The holding pressure affects shrinkage, while holding time is the dominant factor in determining warpage. In turn, in the case of thin-walled products, the melting point of processed polymer and holding pressure are the parameters that have the greatest impact on their shrinkage [23]. The shrinkage differences between thin and thick walls can cause the warpage of products and since that there are special design rules used for the injection moulded parts [24]. It has been shown in [25] that cooling time and holding time have a smaller effect on shrinkage and warping, however, optimal levels of both parameters are required in the thin-walled part forming process to achieve the best possible results. In addition, the shrinkage values vary depending on the distance from the gate. Conventional strategies for controlling shrinkage, despite limited opportunities to improve the quality of injection moulding, include optimization of the number and location of gates (injection points), cooling system and mould conditions, and secondary annealing [21]. As it was proved on the example of polypropylene [26], the value of plastic Melt Flow Rate (MFR or MFI) influences moulded parts' shrinkage. The values of shrinkage are smaller in the case of higher MFR. The shrinkage sensitivity on different processing parameters makes the prediction of the final part dimensions very complex and that's why the optimization of processing parameters can be used to identify the shrinkage dependence on the parameters' values and to minimize the shrinkage as well [27-29].

2. Purpose and scope of research

The aim of this work was to evaluate the influence of injection moulding conditions (injection temperature, mould temperature and injection speed (and therefore injection time) on the shrinkage and degree of crystallinity of injection moulded parts. In the investigations, polypropylene Moplen HP648T (Basell Polyolefins) was used (Melt Flow Rate (230°C/2.16 kg) 53 g/10 min, and Vicat Softening Temperature (A50) 154°C). 2% of a green dye 47145F PE (RAL 6017) (Lifocolor) was also added to the material. The maximum processing temperature of the dye was 290°C. The test samples, in form of "house-shaped" moulded parts according to PN-EN ISO 294-4:2019-03 standard, were produced using a Krauss-Maffei KM65-160 C4 injection moulding machine with a mould clamping force of 65 tons (650 kN). The injection moulding machine was equipped with a Tempro Plus 140 mould thermostating device (Wittmann). The 3D model of the moulded parts is shown in Fig. 1, while Fig. 2 shows the characteristic dimensions of the mould cavity.

The variable injection moulding conditions used in the research plan are shown in TABLE 1.

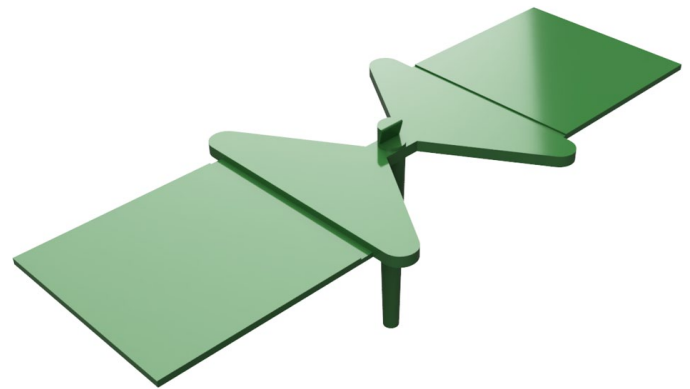

Fig. 1. 3D drawing of injection moulded parts with sprue

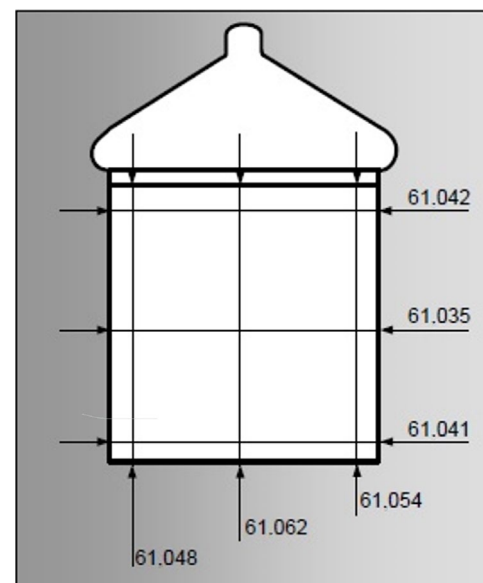

Fig. 2. Characteristic dimensions of the mould cavity (values in mm, determined at 40°C) [30]

TABLE 1

Ranges of variable injection parameters

Parameter	Symbol	Unit	Values		
			1	2	3
Mould temperature	T_m	°C	20 (min)	45 (med.)	70 (max)
Injection temperature	T_{in}	°C	210 (min)	235 (med.)	260 (max)
Injection speed	v	mm/s	15 (min)	67.5 (med.)	120 (max)
Injection time	t_{in}	s	3.8 (max)	1.8 (med.)	0.2 (min)

The remaining injection conditions were as follows:

- injection pressure: 80 MPa,
- holding pressure: 60 MPa,
- holding time: 30 s,
- cooling time: 6 s.

These parameters were determined on the basis of preliminary tests, so that the moulded parts were of good quality, i.e. they did not have any burns, sink marks, etc. The research plan is presented in TABLE 2. The injection speed depends on the injection time, therefore it has been marked in the table of research plan.

TABLE 2

Research plan parameters: mould temperature, injection temperature, injection speed and injection time

Series number	Mould temperature	Injection temperature	Injection speed	Injection time
	T_m , °C	T_{in} , °C	v , mm/s	t_{in} , s
1	20 (min)	235 (med.)	67.5 (med.)	1.8 (med.)
2	70 (max)	235 (med.)	67.5 (med.)	1.8 (med.)
3	45 (med.)	210 (min)	67.5 (med.)	1.8 (med.)
4	45 (med.)	260 (max)	67.5 (med.)	1.8 (med.)
5	45 (med.)	235 (med.)	15 (min)	3.8 (max)
6	45 (med.)	235 (med.)	120 (max)	0.2 (min)
7	45 (med.)	235 (med.)	67.5 (med.)	1.8 (med.)

3. Research equipment

The longitudinal and transversal shrinkage was measured with a Vis Sylvac System digital micrometer with an accuracy of ± 0.01 mm, 24 hours after the injection cycle had been completed. The thermal properties of the samples were tested by the Differential Scanning Calorimetry (DSC) method with the use of a heat-flux DSC calorimeter: Polyma 214 (Netzsch). From the obtained thermograms, the degree of crystallinity, the enthalpy of melting (ΔH_m), the peak melting point (T_m) and the melting temperature range were determined. The samples in the form of test pieces weighing about 10 mg were heated up to the temperature of 220°C under a nitrogen atmosphere. These samples were cut out from the bottom edges of the injection moulded specimens for shrinkage measurements. It means that the areas of the end of the plastic flow were compared in DSC tests.

4. Processing shrinkage measurement results

The work involved measurements of the transversal and longitudinal processing shrinkage. The transversal shrinkage was determined at 3 points (places) of the mouldings: at the beginning of the part length (P1), in the middle of the moulded part (P2), and at the end of the moulded part length (P3). The longitudinal shrinkage was determined at one point, in the centre of the part (W). The measurement places are marked in Figs. 3, 5, 7 and 9.

When analysing the results of the transversal processing shrinkage at point P1 (Fig. 4), it can be noticed that the highest shrinkage values (of about 1.6%) occur at a high value of the mould temperature (70°C – moulded parts from series 2), and at the lowest value of injection temperature (210°C – moulded parts from series 3). The lowest values of shrinkage at the P1 point (about 1.52%) occur in the case of parts obtained at a low value of the mould temperature (20°C – series 1), and at the highest injection temperature (260°C – series 4). Comparing samples obtained at the extreme values of the injection speed (parts from series 5 and 6), it can be noticed, that the increase of the injection speed contributes to the increase of shrinkage from 1.54% to 1.57%.

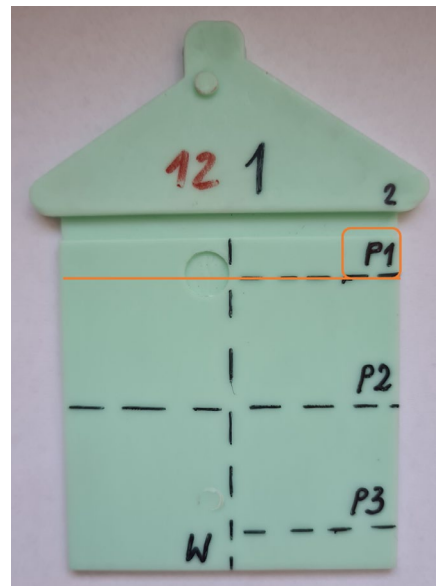

Fig. 3. Place of measuring the processing shrinkage at point P1

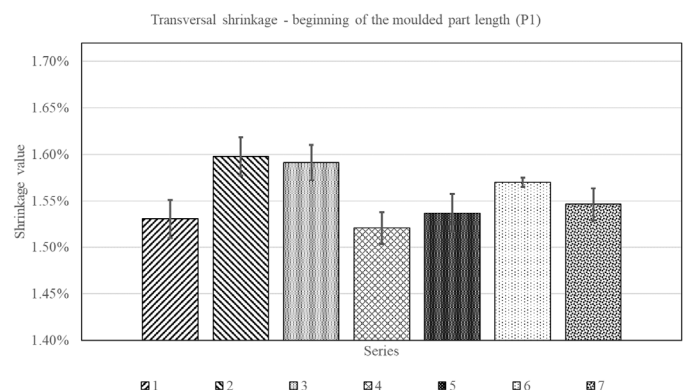

Fig. 4. The results of the transversal processing shrinkage at the beginning of the moulding length (point P1)

1.57%. The series 7 samples were obtained with the mean values of the test plan.

The greatest difference between the shrinkage extremes at point P1 (approximately 5%) was observed between the samples obtained at the highest mould temperature (Series 2) and those obtained at the highest injection temperature (Series 4).

Comparing the results (Fig. 6) of transversal shrinkage in the middle of the length of the moulded part (in point P2), it can be stated that the highest shrinkage values (ranging from 1.68 ÷ 1.69%) are characteristic for parts obtained at a low injection temperature (210°C – moulded parts from series 3), and the highest injection speed (120 mm/s – parts from series 6). The lowest shrinkage values (1.62%) are characteristic for samples manufactured at a low mould temperature (20°C – series 1), and also at a high injection temperature (260°C – series 4) for which the shrinkage was 1.63%.

From the measurements of the transversal shrinkage at point P2 it was found out that the difference between the extreme values was about 4.1% – the smallest shrinkage value had the moulded parts from series 1, obtained at the lowest injection temperature, and the largest for parts from series 3, obtained at the lowest mould temperature.

In the case of measuring the transversal processing shrinkage at the end of the moulded part length, at the point P3 (Fig. 8), the relationships between the changes in the shrinkage value depending on the injection conditions are similar as in the case of the measurements at the point P2.

The highest shrinkage values (within the range of about 1.66 ÷ 1.67%) characterize moulded parts obtained at low mould temperature (210°C – parts from the series 3) and high injection speed (120 mm/s – parts from the series 6). Lower shrinkage occurs for moulded parts produced at low mould temperature (20°C – parts from series 1) (1.59%), as well as at high injection temperature (260°C – parts from series 4) and is 1.60%.

The moulded parts from series 1 and 6 were characterized by the largest difference in the transversal shrinkage at point P3, amounting to about 4.8%. These differences were observed for the lowest mould temperature (series 1) and the highest injection speed (series 6).

During analysing the changes in the longitudinal shrinkage of the moulded parts depending on the injection parameters at the W point (Fig. 10), it can be noticed, that the highest shrinkage values (1.78%) have the parts injected at the highest mould temperature (70°C – samples from series 2). The lowest shrink-

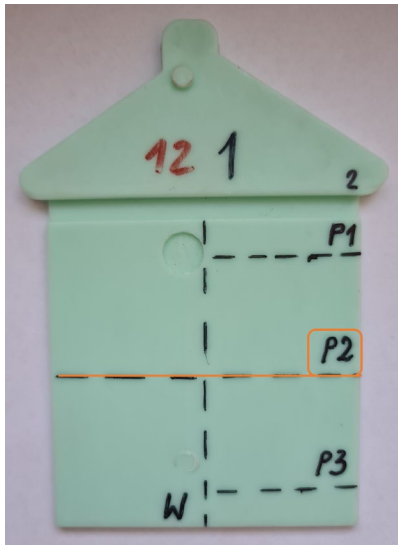

Fig. 5. Place of measuring the processing shrinkage at point P2



Fig. 7. Place of measuring the processing shrinkage at point P3

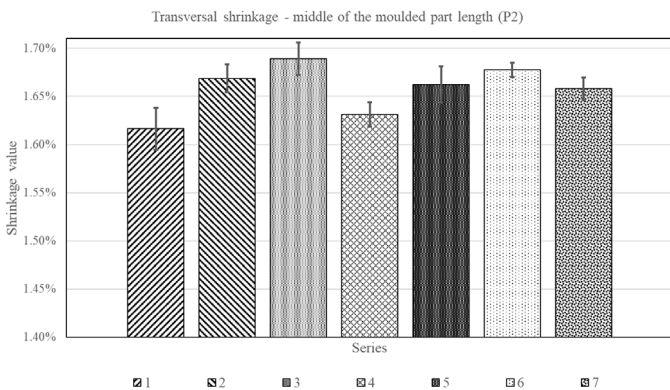

Fig. 6. The results of the transversal processing shrinkage in the middle of the part length (Point P2)

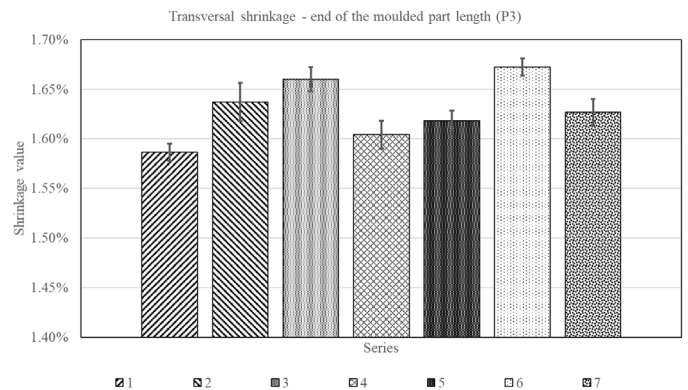

Fig. 8. Results of the transversal processing shrinkage at the end of the moulded part length (point P3)

age value can be observed for series 1 moulded parts, injected at the lowest mould temperature of 20°C.

The difference between the extreme values of the longitudinal shrinkage at the measurement point W was 5.6%.

The nature of changes in the transversal shrinkage value is similar to changes in the longitudinal shrinkage. Differences in the values of achieved shrinkage were observed.

5. The DSC investigations

According to the review of the literature, there is a pressure drop along the flow path of the liquid plastic in an injection mould, due to the increase in the flow resistance. Depending on the adopted processing conditions, there are differences in the pressure recorded in the individual areas of a moulded part, which depend on the shape of the part and cooling method of the mould. This causes different crystallization conditions in these areas, which, in turn, leads to different longitudinal and transversal processing shrinkage.

The results of all tested samples are presented in TABLE 3. The enthalpy of melting was used to calculate the degree of

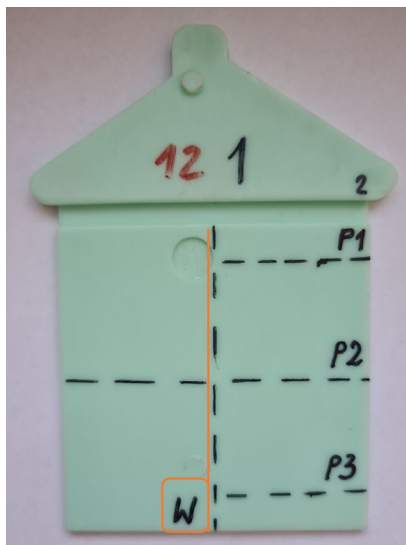

Fig. 9. Place of measurement of longitudinal shrinkage at point W

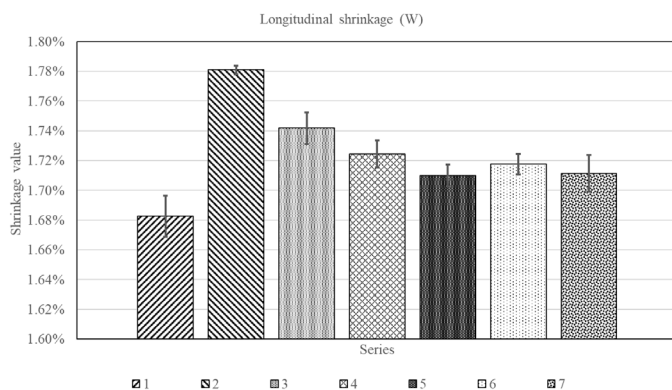

Fig. 10. Results of the longitudinal processing shrinkage in the middle of the moulded part (W point)

TABLE 3

DSC test results: degree of crystallinity, melting temperature, melting range and enthalpy of melting

Series number	Degree of crystallinity, %	Melting temperature, °C	Melting range, °C	Enthalpy of melting, J/g
1	36.05	168.3	155.1-174.6	75.35
2	48.03	166.2	158.6-174.7	100.4
3	46.11	167.8	157.2-174.3	96.38
4	44.40	166.2	161.7-173.5	92.79
5	38.52	167.4	155.0-174.2	80.50
6	45.25	167.0	157.5-173.6	94.57
7	44.08	168.0	153.8-175.0	92.12

crystallinity. In order to show the direct influence of processing conditions on the degree of crystallinity of the material and the values characteristic for semi-crystalline materials, the values from the first heating were analysed.

An increase in the value of the enthalpy of melting indicates an increase in the mass fraction of the crystalline phase in the structure. The results of the first heating show that the mould temperature had the greatest impact on the value of the melting enthalpy, and thus the degree of crystallinity. The samples made at the mould temperature of 70°C (serie 2) were characterized by the highest degree of crystallinity. This situation may be due to the tendency for the molecular chains to arrange themselves during post-mould cooling at an elevated mould temperature. An increase in mould temperature helps to reduce the temperature difference between the molten polymer and the mould cavity, so that the polymer molecules have the right temperature range and sufficient time to crystallize. The impact of the injection temperature on the degree of crystallinity is also remarkable (series 3 and 4). A plastic of a lower temperature value is characterized by higher viscosity, which favours the orientation of polymer molecules in the direction as they flow through the mould. This will result in higher crystallinity degree. In addition, higher molten polymer temperature increases the relaxation and disorientation of the polymer molecules during the cooling process.

The decrease in mould temperature and the increase in injection temperature increased the value of the peak melting point. The lowest melting point value was observed for T_m of 70°C and T_{in} = 210°C, which was 166.2°C. The injection temperature had the greatest impact on the melting range – the samples made at 210°C had the narrowest range of the beginning and end of melting.

High mould temperature and high injection speed contribute to increasing the degree of crystallinity of the tested plastic. Extremely high values of these processing parameters contribute to an increase in the temperature of the processed material, and thus also contribute to an increase in the melting enthalpy.

6. Conclusions

In this study the impact of injection moulding conditions (injection temperature, mould temperature and injection speed) on changes in the shrinkage value and the degree of crystallinity of mouldings was investigated.

Differences in the values of transversal shrinkage in particular areas of mouldings indicate different conditions of their solidification, which occur during the filling, holding and cooling phases. This fact may result from the nature of rheological and thermal phenomena that take place during the flow and cooling of the material in the mould. The tests showed the occurrence of shrinkage differentiation in individual areas of the mouldings. The transversal shrinkage is greater at locations further from the gate than directly behind the gate. The reason for this may be the occurrence of different temperature values of the material along its flow path in the moulding cavity.

When analysing changes in the value of transversal processing shrinkage, it can be noticed that the shrinkage decreases with decreasing mould temperature (series 1). The transversal shrinkage also decreases with increasing injection temperature (comparison of series 3 and 4). Increasing the injection speed contributes to an increase in the value of the transversal shrinkage. In the case of longitudinal shrinkage the relationships are similar to those observed for the transversal shrinkage.

The results of the first heating in DSC examination show that the mould temperature had the greatest impact on the value of the degree of crystallinity. The samples made at the mould temperature of 70°C were characterized by the highest degree of crystallinity. The conclusion of this part of the research is that higher degree of crystallinity of the mouldings' material results in higher mouldings' shrinkage.

REFERENCES

- [1] X.-P. Dang, *Simul. Model. Pract. Theory* **41**, 15-27 (2014). DOI: <https://doi.org/10.1016/j.simpat.2013.11.003>
- [2] M. Kurt, Y. Kaynak, O.S. Kamber, B. Mutlu, B. Bakir, U. Koklu, *Int. J. Adv. Manuf. Technol.* **46**, 571-578 (2010). DOI: <https://doi.org/10.1007/s00170-009-2149-x>
- [3] J.S. Han, C.W. Gal, J.H. Kim, S.J. Park, *Ceram. Int.* **42** (8), 9475-9481 (2016). DOI: <https://doi.org/10.1016/j.ceramint.2016.03.011>
- [4] C. Leyva-Porras, A. Balderrama-Aguilar, Y. Estrada-Ávila, I. Espelosín-Gómez, M. Mendoza-Duarte, C. Piñón-Balderrama, M.Z. Saavedra-Leos, I. Estrada-Moreno, *Polymers* **13** (20), 3597-3609 (2021). DOI: <https://doi.org/10.3390/polym13203597>
- [5] E. Farotti, M. Natalini, *Procedia Struct. Ineg.* **8**, 256-264 (2018). DOI: <https://doi.org/10.1016/j.prostr.2017.12.027>
- [6] Y. Liu, X. Zhao, W. Hua, T. Yu, D. Zhao, Y. Jin, T. Zhu, *Polym. Eng. Sci.* **62** (7), 2119-2130 (2022). DOI: <https://doi.org/10.1002/pen.25993>
- [7] R. Abdul, G. Guo, J.C. Chen, J.J.-W. Yoo, *Int. J. Interact. Des. Manuf.* **14**, 345-357 (2020). DOI: <https://doi.org/10.1007/s12008-019-00593-4>
- [8] E. Hakimian, A.B. Sulong, *Mater. Des.* **42**, 62-71 (2012). DOI: <https://doi.org/10.1016/j.matdes.2012.04.058>
- [9] S.-H. Nian, C.-Y. Wu, M.-S. Huang, *Int. Commun. Heat Mass Transf.* **61**, 102-110 (2015). DOI: <https://doi.org/10.1016/j.icheatmasstransfer.2014.12.008>
- [10] H. Hassan, N. Regnier, C. Pujos, E. Arquis, G. Defaye, *Appl. Therm. Eng.* **30**, 1547-1557 (2010). DOI: <https://doi.org/10.1016/j.applthermaleng.2010.02.025>
- [11] T. Jachowicz, I. Gajdoš, V. Krasinskyi, *Adv. Sci. Technol. Res. J.* **8** (23), 6-13 (2014). DOI: <https://doi.org/10.12913/22998624.1120308>
- [12] A. Kościuszko, D. Marciniak, D. Sykutera, *Mater.* **14** (1), 22-37 (2021). DOI: <https://doi.org/10.3390/ma14010022>
- [13] R. Sánchez, J. Aisa, A. Martínez, D. Mercado, *Measurement* **45** (5), 1051-1056 (2012). DOI: <https://doi.org/10.1016/j.measurement.2012.01.039>
- [14] M.-L. Wang, R.Y. Chang, C.-H. Hsu, *Molding Simulation. Theory and Practice*, Hanser Publishers, Munich, Cincinnati (2018).
- [15] M.A. Barghash, F.A. Alkaabneh, *Qual. Eng.* **26** (3), 319-334 (2014). DOI: <https://doi.org/10.1080/08982112.2013.852679>
- [16] B. Kowalska, *Polimery* **52** (4), 280-285 (2007). DOI: <https://doi.org/10.14314/polimery>
- [17] R. Wang, J. Zeng, X. Feng, Y. Xia, *J. Macromol. Sci. Phys.* **52** (1), 206-221 (2012). DOI: <https://doi.org/10.1080/00222348.2012.700234>
- [18] M. Altan, *Mater. Des.* **31** (1), 599-604 (2010). DOI: <https://doi.org/10.1016/j.matdes.2009.06.049>
- [19] K.M.B. Jansen, D.J. Van Dijk, M.H. Husselman, *Polym. Eng. Sci.* **38** (5), 838-846 (1998). DOI: <https://doi.org/10.1002/pen.10249>
- [20] P. Postawa, *Polimery* **50** (3), 201-207 (2005). DOI: <https://doi.org/10.14314/polimery>
- [21] S.-H. Nian, M.-H. Li, M.-S. Huang, *Int. J. Heat Mass Transf.* **86**, 358-368 (2015). DOI: <https://doi.org/10.1016/j.ijheatmasstransfer.2015.03.027>
- [22] F. Liu, S. Zeng, H. Zhou, J. Li, *J. Appl. Polym. Sci.* **125** (1), 731-744 (2012). DOI: <https://doi.org/10.1002/app.35564>
- [23] D. Masato, J. Rathore, M. Sorgato, S. Carmignato, G. Lucchetta, *Mater. Des.* **132**, 496-504 (2017). DOI: <https://doi.org/10.1016/j.matdes.2017.07.032>
- [24] J.M. Fisher, *Handbook of molded part shrinkage and warpage*. Plastic Design Library, William Andrew Inc., Norwich 2003.
- [25] M.D. Azaman, S.M. Sapuan, S. Sulaiman, E.S. Zainudin, A. Khalina, *Mater. Des.* **52**, 1018-1026 (2013). DOI: <https://doi.org/10.1016/j.matdes.2013.06.047>
- [26] A.J. Pontes, M.J. Oliveira, A.Z. Pozada, *Materials Sci. Forum* **455-456**, 814-817 (2004). DOI: <https://doi.org/10.4028/www.scientific.net/MSF.455-456.814>
- [27] M. Bogucki, S. Płaska, P. Stączek, *Polimery* **48** (10), 714-719 (2003). DOI: <https://doi.org/10.14314/polimery>
- [28] H. Radhwan, M.T. Mustafa, A.F. Anuar, H. Azmi, M.Z. Zakaria, A.N.M. Khalil, *J. Adv. Research* **10** (1), 1-8 (2015).
- [29] G. Hiyane-Nashiro, M. Hernández-Hernández, J. Rojas-García, J. Rodríguez-Resendiz, J.M., Álvarez-Alvarado, *Polymers* **14** (23), 5133 (2022). DOI: <https://doi.org/10.3390/polym14235133>
- [30] P. Postawa, *Analysis of the influence of processing conditions on the shaping of selected characteristics of injection mouldings*. PhD thesis, Czestochowa University of Technology, Czestochowa, 2003.