

Determination of slot leakage inductance for three-phase induction motor winding using an analytical method

JAN STASZAK

*Department of Electrical Machines and Mechatronic Systems
Kielce University of Technology
al. Tysiąclecia PP 7, Kielce, Poland
e-mail: meljs@tu.kielce.pl*

(Received: 23.04.2012, revised: 05.04.2013)

Abstract: The article introduced some expressions for self- and mutual slot leakage inductance of phase windings for the mathematical model of an induction machine in the natural phase coordinate system and for $dq0$ model and in an arbitrary coordinate frame. Calculation of self- and mutual slot leakage inductance have been performed for three-phase double-layer, delta and delta-modified winding connections. Introduced expressions may be useful in the design of windings and in the analysis of dynamic states of AC electrical machines.

Key words: slot leakage inductance, self- and mutual inductances, induction motor

1. Introduction

The analysis of dynamic states of induction machines can be carried out in the natural three-phase system [6, 7] or in the common arbitrary reference frame. The matrix of mutual inductances between the stator and rotor windings L_{sr} in the natural coordinate frame depends on electric angle ϑ between a axes of the stator and rotor windings. Introduction of a common arbitrary reference frame for the stator and rotor makes that the mutual inductance matrix L_{sr} has its coefficients which are angle-independent on the rotor rotation. In the classical theory of electrical machines we may discriminate inductance of the stator and rotor windings, associated with the main magnetic flux and the inductance associated with leakage flux. The issue of determining the self- and mutual inductances associated with the main flux has been widely discussed in the literature [1, 3, 4, 7]. The inductance is determined under the knowledge of the spatial distribution of the stator magnetic flux and its ampere-turns [1, 6, 7, 9, 11]. However, much of the problem gives rise to the determination of the leakage inductance of windings. In the monoharmonic model of three-phase induction machine the leakage flux of each winding consists of slot leakage flux, air-gap leakage flux, end winding and skew leakage flux. The largest participation in the total leakage flux has the component associated with the slot leakage one. So far, to calculate the slot leakage inductance are generally used the complex values [5, 11]. This way the slot leakage inductance is determined for steady state

of an induction machine. The use of complex values does not allow to determinate of self- and mutual inductances of slot leakage. The book [7] introduced dependencies the self- and mutual inductances of slot leakage flux for the double-layer winding, using instantaneous values of stator's currents. This book presents how to determine the self- and mutual inductances of the slot leakage flux for the mathematical model in natural three-phase system and for $dq0$ model in an arbitrary reference frame. Calculations have been performed for three-phase double-layer, delta and delta-modified windings. In such windings, the common slot has two sides of different coils, and in some slots, the sides may belong to different phases. This produces mutual slot leakage inductance for the single-layer winding which equal to zero.

2. A mathematical model of three-phase induction machine for the natural phase system

Arrangement of the stator and rotor windings in symmetrical three-phase induction machine with one pair of poles is shown in Figure 1. Three-phase induction machine is considered as a system of magnetically coupled stator- and rotor windings. The fixed magnetic axes a_s, b_s, c_s for the stator and the rotating magnetic axes a_r, b_r, c_r of the rotor are moving each to other with angular electric velocity ω . The stator windings are identical and symmetrical distributed, by 120 electrical degrees. Similarly, three-phase rotor winding consists of three identical distributed windings, displaced in space by 120 electrical degrees [6, 7].

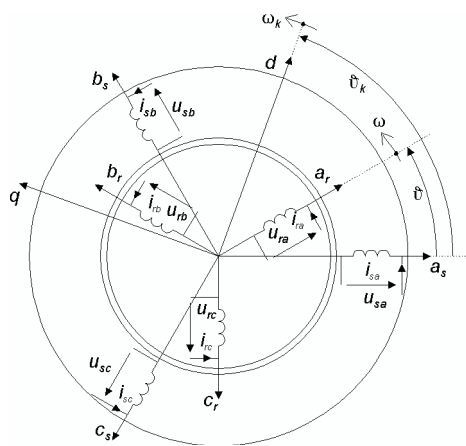

Fig. 1. Arrangement of three-phase windings of the induction machine and the reference stator and rotor variables within common reference frame

Voltage equations of the stator and rotor's winding in the natural reference frame in the matrix form are [6, 7]

$$\left. \begin{aligned} \mathbf{u}_s &= \mathbf{R}_s \mathbf{i}_s + \frac{d\boldsymbol{\Psi}_s}{dt} \\ \mathbf{u}_r &= \mathbf{R}_r \mathbf{i}_r + \frac{d\boldsymbol{\Psi}_r}{dt} \end{aligned} \right\}, \quad (1)$$

where: $\mathbf{u}_s, \mathbf{u}_r, \mathbf{i}_s, \mathbf{i}_r, \boldsymbol{\Psi}_s, \boldsymbol{\Psi}_r$ – column vectors of voltages, currents and leakage fluxes associated stator and rotor windings, $\mathbf{R}_s, \mathbf{R}_r$ – matrix of the stator and rotor winding resistance

$$\mathbf{u}_s = \begin{Bmatrix} u_{sa} \\ u_{sb} \\ u_{sc} \end{Bmatrix}, \quad \mathbf{i}_s = \begin{Bmatrix} i_{sa} \\ i_{sb} \\ i_{sc} \end{Bmatrix}, \quad \boldsymbol{\Psi}_s = \begin{Bmatrix} \Psi_{sa} \\ \Psi_{sb} \\ \Psi_{sc} \end{Bmatrix}, \quad (2)$$

$$\mathbf{u}_r = \begin{Bmatrix} u_{ra} \\ u_{rb} \\ u_{rc} \end{Bmatrix}, \quad \mathbf{i}_r = \begin{Bmatrix} i_{ra} \\ i_{rb} \\ i_{rc} \end{Bmatrix}, \quad \boldsymbol{\Psi}_r = \begin{Bmatrix} \Psi_{ra} \\ \Psi_{rb} \\ \Psi_{rc} \end{Bmatrix}. \quad (3)$$

Matrices of stator and rotor resistances are diagonal

$$\mathbf{R}_s = \begin{bmatrix} R_s & 0 & 0 \\ 0 & R_s & 0 \\ 0 & 0 & R_s \end{bmatrix}, \quad \mathbf{R}_r = \begin{bmatrix} R_r & 0 & 0 \\ 0 & R_r & 0 \\ 0 & 0 & R_r \end{bmatrix}, \quad (4)$$

where: R_s, R_r – resistance of one phase winding of stator and rotor

Stator $\boldsymbol{\Psi}_s$ and rotor $\boldsymbol{\Psi}_r$ linked fluxes can be expressed by the inductance matrices by the following equations

$$\left. \begin{aligned} \boldsymbol{\Psi}_s &= \mathbf{L}_s \mathbf{i}_s + \mathbf{L}_{sr}(\vartheta) \mathbf{i}_r \\ \boldsymbol{\Psi}_r &= \mathbf{L}_{rs}(\vartheta) \mathbf{i}_s + \mathbf{L}_r \mathbf{i}_r \end{aligned} \right\}, \quad (5)$$

where: $\mathbf{L}_s, \mathbf{L}_r$ – stator and rotor self inductance matrix, \mathbf{L}_{sr} – matrix of mutual inductances between stator and rotor windings, $\mathbf{L}_{rs} = \mathbf{L}_{sr}^T$, ϑ – electrical angle between the rotor and stator (Fig. 1).

In the above equations, the index s refers to variables and parameters of stator circuits and index r to variables and parameters of the rotor's circuit. Matrices of self inductance of stator and rotor consist of a matrix of self inductance associated with the main flux and the matrix associated with the leakage inductance associated with leakage flux

$$\mathbf{L}_s = \mathbf{L}_{ms} + \mathbf{L}_{\sigma s}, \quad \mathbf{L}_r = \mathbf{L}_{mr} + \mathbf{L}_{\sigma r} \quad (6)$$

where: $\mathbf{L}_{ms}, \mathbf{L}_{mr}$ – matrixes of self inductances of stator and rotor, connected with the main flux in air gap, $\mathbf{L}_{\sigma s}, \mathbf{L}_{\sigma r}$ – matrixes of leakage inductances of stator and rotor. Matrices of leakage inductance of stator and rotor of (3×3) dimensions are symmetric matrices and contain their self inductance leakage flux and the mutual inductance leakage flux

$$\mathbf{L}_{\sigma s} = \begin{bmatrix} L_{\sigma se} & L_{\sigma ms} & L_{\sigma ms} \\ L_{\sigma ms} & L_{\sigma se} & L_{\sigma ms} \\ L_{\sigma ms} & L_{\sigma ms} & L_{\sigma se} \end{bmatrix}, \quad \mathbf{L}_{\sigma r} = \begin{bmatrix} L_{\sigma re} & L_{\sigma mr} & L_{\sigma mr} \\ L_{\sigma mr} & L_{\sigma re} & L_{\sigma mr} \\ L_{\sigma mr} & L_{\sigma mr} & L_{\sigma re} \end{bmatrix}, \quad (7)$$

where: $L_{\sigma se}$, $L_{\sigma re}$ – leakage flux self inductance of one phase of stator and rotor's winding, $L_{\sigma ms}$, $L_{\sigma mr}$ – mutual inductance of leakage flux between the stator windings or rotor windings.

In the single-layer and full-pitch double-layer windings the stator and rotor mutual leakage inductances are equal to zero. Self inductance matrices of stator and rotor connected with the main flux of (3×3) dimensions are symmetric matrices with constant coefficients

$$\mathbf{L}_{ms} = L_{ms} \begin{bmatrix} 1 & -\frac{1}{2} & -\frac{1}{2} \\ -\frac{1}{2} & 1 & -\frac{1}{2} \\ -\frac{1}{2} & -\frac{1}{2} & 1 \end{bmatrix}, \quad \mathbf{L}_{mr} = L_{mr} \begin{bmatrix} 1 & -\frac{1}{2} & -\frac{1}{2} \\ -\frac{1}{2} & 1 & -\frac{1}{2} \\ -\frac{1}{2} & -\frac{1}{2} & 1 \end{bmatrix}, \quad (8)$$

where: L_{ms} , L_{mr} – magnetizing inductance of the stator and rotor windings connected with the main flux.

Magnetizing inductance of stator L_{ms} and rotor L_{mr} are defined by expressions [6, 9]

$$L_{ms} = \frac{4}{\pi} \frac{\mu_0 r l_e}{\delta_e} \left(\frac{N_s k_{ws}}{p} \right)^2, \quad L_{mr} = \frac{4}{\pi} \frac{\mu_0 r l_e}{\delta_e} \left(\frac{N_r k_{wr}}{p} \right)^2 = \frac{1}{n_{sr}^2} L_{ms}, \quad (9)$$

where: μ_0 – magnetic permeability of vacuum, r – average radius of air gap, δ_e – effective thickness of air gap, l_e – effective length of the stator's core, N_s , N_r – number of series connected turns in windings stator and rotor's phase, k_{ws} , k_{wr} – coefficients of stator and rotor's windings, n_{sr} – turn ratio, whereby

$$n_{sr} = \frac{N_s k_{ws}}{N_r k_{wr}}. \quad (10)$$

The matrix of mutual inductance between the stator and rotor windings \mathbf{L}_{sr} is a matrix with coefficients depending on electrical angle of rotor rotation \mathcal{G}

$$\mathbf{L}_{sr} = L_{msr} \begin{bmatrix} \cos(\mathcal{G}) & \cos(\mathcal{G} + \frac{2}{3}\pi) & \cos(\mathcal{G} + \frac{4}{3}\pi) \\ \cos(\mathcal{G} + \frac{4}{3}\pi) & \cos(\mathcal{G}) & \cos(\mathcal{G} + \frac{2}{3}\pi) \\ \cos(\mathcal{G} + \frac{2}{3}\pi) & \cos(\mathcal{G} + \frac{4}{3}\pi) & \cos(\mathcal{G}) \end{bmatrix}, \quad (11)$$

L_{msr} maximum mutual inductance between the stator and rotor windings is determined by relation [6, 9]

$$L_{msr} = \frac{4}{\pi} \frac{\mu_0 r l_e}{\delta_e} \left(\frac{N_s k_{ws}}{p} \right) \left(\frac{N_r k_{wr}}{p} \right) = \frac{1}{n_{sr}} L_{ms}. \quad (12)$$

Taking into account (5) between the fluxes associated with the stator and rotor windings and

stator and rotor currents, the voltage equations for the stator and rotor (1) take the following form

$$\left. \begin{aligned} \mathbf{u}_s &= \mathbf{R}_s \mathbf{i}_s + \mathbf{L}_s \frac{d\mathbf{i}_s}{dt} + \mathbf{L}_{sr}(\vartheta) \frac{d\mathbf{i}_r}{dt} + \frac{d\mathbf{L}_{sr}(\vartheta)}{dt} \mathbf{i}_r \\ \mathbf{u}_r &= \mathbf{R}_r \mathbf{i}_r + \mathbf{L}_r \frac{d\mathbf{i}_r}{dt} + \mathbf{L}_{rs}(\vartheta) \frac{d\mathbf{i}_s}{dt} + \frac{d\mathbf{L}_{rs}(\vartheta)}{dt} \mathbf{i}_s \end{aligned} \right\} \quad (13)$$

Taking into consideration the time derivatives of the inductances

$$\left. \begin{aligned} \frac{d\mathbf{L}_{sr}(\vartheta)}{dt} &= \frac{d\mathbf{L}_{sr}(\vartheta)}{d\vartheta} \frac{d\vartheta}{dt} = \frac{d\mathbf{L}_{sr}(\vartheta)}{d\vartheta} \omega \\ \frac{d\mathbf{L}_{rs}(\vartheta)}{dt} &= \frac{d\mathbf{L}_{rs}(\vartheta)}{d\vartheta} \frac{d\vartheta}{dt} = \frac{d\mathbf{L}_{rs}(\vartheta)}{d\vartheta} \omega \end{aligned} \right\} \quad (14)$$

the matrix Equations (13) can be written as

$$\left. \begin{aligned} \mathbf{u}_s &= \mathbf{R}_s \mathbf{i}_s + \mathbf{L}_s \frac{d\mathbf{i}_s}{dt} + \mathbf{L}_{sr}(\vartheta) \frac{d\mathbf{i}_r}{dt} + \omega \frac{d\mathbf{L}_{sr}(\vartheta)}{d\vartheta} \mathbf{i}_r \\ \mathbf{u}_r &= \mathbf{R}_r \mathbf{i}_r + \mathbf{L}_r \frac{d\mathbf{i}_r}{dt} + \mathbf{L}_{rs}(\vartheta) \frac{d\mathbf{i}_s}{dt} + \omega \frac{d\mathbf{L}_{rs}(\vartheta)}{d\vartheta} \mathbf{i}_s \end{aligned} \right\} \quad (15)$$

In order to do the calculations for the dynamic states of an induction motor the stator and rotor voltage equations (15) should be supplemented by the equation of movement

$$J \frac{d\Omega}{dt} = T_e - T_h, \quad (16)$$

where: J – moment of inertia, T_e – electromagnetic torque, T_h – load torque.

Electromagnetic torque of an induction motor in natural three-phase reference frame is calculated from dependencies [6, 8, 9]

$$T_e = p_b \mathbf{i}_s^T \frac{d\mathbf{L}_{sr}(\vartheta)}{d\vartheta} \mathbf{i}_r. \quad (17)$$

3. A mathematical model of three-phase induction motor in the arbitrary reference frame

In order to simplify the analysis it is convenient to take the rotor variables (voltages, currents and fluxes) for stator side according to turns ratio

$$\mathbf{u}'_r = n_{sr} \mathbf{u}_r, \quad \boldsymbol{\psi}'_r = n_{sr} \boldsymbol{\psi}_r, \quad \mathbf{i}'_r = \frac{\mathbf{i}_r}{n_{sr}}. \quad (18)$$

Considering dependencies (18) the voltage and flux equations take the form

$$\left. \begin{aligned} \mathbf{u}_s &= \mathbf{R}_s \mathbf{i}_s + \frac{d\boldsymbol{\Psi}_s}{dt} \\ \mathbf{u}'_r &= \mathbf{R}'_r \mathbf{i}'_r + \frac{d\boldsymbol{\Psi}'_r}{dt} \end{aligned} \right\}, \quad (19)$$

$$\left. \begin{aligned} \boldsymbol{\Psi}_s &= \mathbf{L}_s \mathbf{i}_s + \mathbf{L}'_{sr}(\vartheta) \mathbf{i}'_r \\ \boldsymbol{\Psi}'_r &= \mathbf{L}'_{rs}(\vartheta) \mathbf{i}_s + \mathbf{L}'_r \mathbf{i}'_r \end{aligned} \right\}. \quad (20)$$

Combining the expressions (18), (9) and (10) with rotor resistance matrix \mathbf{R}'_r and its inductances \mathbf{L}'_r , \mathbf{L}'_{sr} we obtain

$$\mathbf{R}'_r = n_{sr}^2 \mathbf{R}_r, \quad \mathbf{L}'_r = n_{sr}^2 \mathbf{L}_r = \mathbf{L}'_{\sigma r} + \mathbf{L}'_{mr}, \quad (21)$$

$$\mathbf{L}'_{\sigma r} = n_{sr}^2 \mathbf{L}_{\sigma r}, \quad (22)$$

$$\mathbf{L}'_{mr} = L_{ms} \begin{bmatrix} 1 & -\frac{1}{2} & -\frac{1}{2} \\ -\frac{1}{2} & 1 & -\frac{1}{2} \\ -\frac{1}{2} & -\frac{1}{2} & 1 \end{bmatrix}, \quad (23)$$

$$\mathbf{L}'_{sr} = n_{sr} \mathbf{L}_{sr} = L_{ms} \begin{bmatrix} \cos(\vartheta) & \cos(\vartheta + \frac{2}{3}\pi) & \cos(\vartheta + \frac{4}{3}\pi) \\ \cos(\vartheta + \frac{4}{3}\pi) & \cos(\vartheta) & \cos(\vartheta + \frac{2}{3}\pi) \\ \cos(\vartheta + \frac{2}{3}\pi) & \cos(\vartheta + \frac{4}{3}\pi) & \cos(\vartheta) \end{bmatrix}. \quad (24)$$

In order to obtain equations with constant coefficients it is needed to carry out the transformation of the stator and rotor variables to a common arbitrary reference frame $d, q, 0$ which is rotating with any angular velocity ω_k

$$\left. \begin{aligned} \mathbf{u}_{sdq0} &= \mathbf{C} \mathbf{u}_s & \mathbf{i}_{sdq0} &= \mathbf{C} \mathbf{i}_s & \boldsymbol{\Psi}_{sdq0} &= \mathbf{C} \boldsymbol{\Psi}_s \\ \mathbf{u}'_{rdq0} &= \mathbf{D} \mathbf{u}'_r & \mathbf{i}'_{rdq0} &= \mathbf{D} \mathbf{i}'_r & \boldsymbol{\Psi}'_{rdq0} &= \mathbf{D} \boldsymbol{\Psi}'_r \end{aligned} \right\}. \quad (25)$$

The transformation matrix \mathbf{C} of stator phases a, b, c to the arbitrary reference frame of $d, q, 0$ and the inverse matrix \mathbf{C}^{-1} are determined by

$$\mathbf{C} = \frac{2}{3} \begin{bmatrix} \cos(\vartheta_k) & \cos\left(\vartheta_k - \frac{2}{3}\pi\right) & \cos\left(\vartheta_k - \frac{4}{3}\pi\right) \\ -\sin(\vartheta_k) & -\sin\left(\vartheta_k - \frac{2}{3}\pi\right) & -\sin\left(\vartheta_k - \frac{4}{3}\pi\right) \\ \frac{1}{2} & \frac{1}{2} & \frac{1}{2} \end{bmatrix}, \quad (26)$$

$$\mathbf{C}^{-1} = \begin{bmatrix} \cos(\vartheta_k) & -\sin(\vartheta_k) & 1 \\ \cos\left(\vartheta_k - \frac{2}{3}\pi\right) & -\sin\left(\vartheta_k - \frac{2}{3}\pi\right) & 1 \\ \cos\left(\vartheta_k - \frac{4}{3}\pi\right) & -\sin\left(\vartheta_k - \frac{4}{3}\pi\right) & 1 \end{bmatrix}. \quad (27)$$

However, transformation matrix \mathbf{D} of rotor phases a, b, c to the arbitrary reference frame of $d, q, 0$ and the inverse matrix \mathbf{D}^{-1} are determined by

$$\mathbf{D} = \frac{2}{3} \begin{bmatrix} \cos(\vartheta_k - \vartheta) & \cos\left(\vartheta_k - \vartheta - \frac{2}{3}\pi\right) & \cos\left(\vartheta_k - \vartheta - \frac{4}{3}\pi\right) \\ -\sin(\vartheta_k - \vartheta) & -\sin\left(\vartheta_k - \vartheta - \frac{2}{3}\pi\right) & -\sin\left(\vartheta_k - \vartheta - \frac{4}{3}\pi\right) \\ \frac{1}{2} & \frac{1}{2} & \frac{1}{2} \end{bmatrix}, \quad (28)$$

$$\mathbf{D}^{-1} = \begin{bmatrix} \cos(\vartheta_k - \vartheta) & -\sin(\vartheta_k - \vartheta) & 1 \\ \cos\left(\vartheta_k - \vartheta - \frac{2}{3}\pi\right) & -\sin\left(\vartheta_k - \vartheta - \frac{2}{3}\pi\right) & 1 \\ \cos\left(\vartheta_k - \vartheta - \frac{4}{3}\pi\right) & -\sin\left(\vartheta_k - \vartheta - \frac{4}{3}\pi\right) & 1 \end{bmatrix}. \quad (29)$$

In the above-mentioned matrices, ϑ_k angle is an electric angle between stator magnetic axis a and the axis d of common arbitrary reference frame. However, ϑ angle is the angle between the stator axis a and rotor axis a . The time derivatives of the angles ϑ_k and ϑ angles (as indicated in Fig. 1) give the electrical angular velocity ω_k in arbitrary reference frame and electrical angular speed of rotor ω

$$\omega_k = \frac{d\vartheta_k}{dt}, \quad \omega = \frac{d\vartheta}{dt}. \quad (30)$$

The flux-voltage Equations (19) and (20) stored in the common arbitrary reference frame $dq0$, according to dependence (25) give

$$\left. \begin{aligned} \mathbf{u}_{sdq0} &= \mathbf{C}\mathbf{R}_s\mathbf{C}^{-1}\mathbf{i}_{sd0} + \mathbf{C} \frac{d(\mathbf{C}^{-1}\boldsymbol{\Psi}_{sdq0})}{dt} \\ \mathbf{u}'_{rdq0} &= \mathbf{D}\mathbf{R}'_r\mathbf{D}^{-1}\mathbf{i}'_{rdq0} + \mathbf{D} \frac{d(\mathbf{D}^{-1}\boldsymbol{\Psi}'_{rdq0})}{dt} \end{aligned} \right\}, \quad (31)$$

$$\left. \begin{aligned} \boldsymbol{\Psi}_{sdq0} &= \mathbf{C}\mathbf{L}_s\mathbf{C}^{-1}\mathbf{i}_{sdq0} + \mathbf{C}\mathbf{L}'_{sr}(\vartheta)\mathbf{D}^{-1}\mathbf{i}'_{rdq0} \\ \boldsymbol{\Psi}'_{rdq0} &= \mathbf{D}\mathbf{L}'_{rs}(\vartheta)\mathbf{C}^{-1}\mathbf{i}_{sdq0} + \mathbf{D}\mathbf{L}'_r\mathbf{D}^{-1}\mathbf{i}'_{rdq0} \end{aligned} \right\}. \quad (32)$$

After determining the matrix Equations (31) and (32) one can obtain

$$\mathbf{C}\mathbf{R}_s\mathbf{C}^{-1} = \begin{bmatrix} R_s & 0 & 0 \\ 0 & R_s & 0 \\ 0 & 0 & R_s \end{bmatrix}, \quad \mathbf{C}\mathbf{L}'_{sr}(\mathcal{G})\mathbf{D}^{-1} = \begin{bmatrix} \frac{3}{2}L_{ms} & 0 & 0 \\ 0 & \frac{3}{2}L_{ms} & 0 \\ 0 & 0 & 0 \end{bmatrix}, \quad \mathbf{D}\mathbf{R}'_r\mathbf{D}^{-1} = \begin{bmatrix} R'_r & 0 & 0 \\ 0 & R'_r & 0 \\ 0 & 0 & R'_r \end{bmatrix}, \quad (33)$$

$$\mathbf{C}\mathbf{L}_s\mathbf{C}^{-1} = \begin{bmatrix} L_{\sigma s} & 0 & 0 \\ 0 & L_{\sigma s} & 0 \\ 0 & 0 & L_{\sigma 0s} \end{bmatrix} + \begin{bmatrix} \frac{3}{2}L_{ms} & 0 & 0 \\ 0 & \frac{3}{2}L_{ms} & 0 \\ 0 & 0 & 0 \end{bmatrix}, \quad (34)$$

$$\mathbf{D}\mathbf{L}'_r\mathbf{D}^{-1} = \begin{bmatrix} L'_{\sigma r} & 0 & 0 \\ 0 & L'_{\sigma r} & 0 \\ 0 & 0 & L'_{\sigma 0r} \end{bmatrix} + \begin{bmatrix} \frac{3}{2}L_{ms} & 0 & 0 \\ 0 & \frac{3}{2}L_{ms} & 0 \\ 0 & 0 & 0 \end{bmatrix}, \quad (35)$$

$$\left. \begin{aligned} \mathbf{C} \frac{d(\mathbf{C}^{-1}\boldsymbol{\Psi}_{sdq0})}{dt} &= \omega_k \mathbf{K}_s \boldsymbol{\Psi}_{sdq0} + \frac{d\boldsymbol{\Psi}_{sdq0}}{dt} \\ \mathbf{D} \frac{d(\mathbf{D}^{-1}\boldsymbol{\Psi}_{rdq0})}{dt} &= (\omega_k - \omega) \mathbf{K}_r \boldsymbol{\Psi}_{sdq0} + \frac{d\boldsymbol{\Psi}_{sdq0}}{dt} \end{aligned} \right\}, \quad (36)$$

where:

$$\mathbf{K}_s = \mathbf{K}_r = \begin{bmatrix} 0 & -1 & 0 \\ 1 & 0 & 0 \\ 0 & 0 & 0 \end{bmatrix}.$$

Diagonal matrix of leakage inductance contains stator leakage inductance $L_{\sigma s}$ and rotor one $L_{\sigma r}$ as well as stator leakage inductance $L_{\sigma 0s}$ and the rotor $L_{\sigma 0r}$ one

$$\left. \begin{aligned} L_{\sigma s} &= L_{\sigma es} - L_{\sigma ms} & L_{\sigma r} &= L_{\sigma er} - L_{\sigma mr} \\ L_{\sigma 0s} &= L_{\sigma es} + 2L_{\sigma ms} & L_{\sigma 0r} &= L_{\sigma er} + 2L_{\sigma mr} \end{aligned} \right\}. \quad (37)$$

Leakage inductances of stator $L_{\sigma s}$ and rotor $L_{\sigma r}$ are the difference of self leakage inductance of a particular winding and mutual leakage inductances between the phase windings of the stator or rotor. Such inductance is winding leakage inductance of the components d, q of leakage flux. However, the leakage stator inductance $L_{\sigma 0s}$ and rotor $L_{\sigma 0r}$ is winding leakage inductance for zero leakage flux sequence component. It is the sum of winding self leakage inductance and double mutual leakage inductance of stator or rotor's windings.

Taking into account the dependencies (33)-(36) the matrix equations of the stator and rotor voltages (31) and fluxes (32) in the system of coordinates $d, q, 0$ (in the arbitrary reference-frame) takes the form of

$$\left. \begin{aligned} \mathbf{u}_{sdq0} = \begin{Bmatrix} u_{sd} \\ u_{sq} \\ u_{s0} \end{Bmatrix} &= \begin{bmatrix} R_s & 0 & 0 \\ 0 & R_s & 0 \\ 0 & 0 & R_s \end{bmatrix} \begin{Bmatrix} i_{sd} \\ i_{sq} \\ i_{s0} \end{Bmatrix} + \frac{d}{dt} \begin{Bmatrix} \Psi_{sd} \\ \Psi_{sq} \\ \Psi_{s0} \end{Bmatrix} + \omega_k \begin{Bmatrix} -\Psi_{sq} \\ \Psi_{sd} \\ 0 \end{Bmatrix} \\ \mathbf{u}_{rdq0} = \begin{Bmatrix} u'_{rd} \\ u'_{rq} \\ u'_{r0} \end{Bmatrix} &= \begin{bmatrix} R'_r & 0 & 0 \\ 0 & R'_r & 0 \\ 0 & 0 & R'_r \end{bmatrix} \begin{Bmatrix} i'_{rd} \\ i'_{rq} \\ i'_{r0} \end{Bmatrix} + \frac{d}{dt} \begin{Bmatrix} \Psi_{rd} \\ \Psi_{rq} \\ \Psi_{r0} \end{Bmatrix} + (\omega_k - \omega) \begin{Bmatrix} -\Psi_{rq} \\ \Psi_{rd} \\ 0 \end{Bmatrix} \end{aligned} \right\}, \quad (38a)$$

$$\left. \begin{aligned} \Psi_{sdq0} = \begin{Bmatrix} \Psi_{sd} \\ \Psi_{sq} \\ \Psi_{s0} \end{Bmatrix} &= \begin{bmatrix} L_{\sigma s} + L_m & 0 & 0 \\ 0 & L_{\sigma s} + L_m & 0 \\ 0 & 0 & L_{\sigma s0} \end{bmatrix} \begin{Bmatrix} i_{sd} \\ i_{sq} \\ i_{s0} \end{Bmatrix} + \begin{bmatrix} L_m & 0 & 0 \\ 0 & L_m & 0 \\ 0 & 0 & 0 \end{bmatrix} \begin{Bmatrix} i'_{rd} \\ i'_{rq} \\ i'_{r0} \end{Bmatrix} \\ \Psi_{rdq0} = \begin{Bmatrix} \Psi'_{rd} \\ \Psi'_{rq} \\ \Psi'_{r0} \end{Bmatrix} &= \begin{bmatrix} L_m & 0 & 0 \\ 0 & L_m & 0 \\ 0 & 0 & 0 \end{bmatrix} \begin{Bmatrix} i_{sd} \\ i_{sq} \\ i_{s0} \end{Bmatrix} + \begin{bmatrix} L_m + L'_{\sigma r} & 0 & 0 \\ 0 & L_m + L'_{\sigma r} & 0 \\ 0 & 0 & L'_{\sigma r0} \end{bmatrix} \begin{Bmatrix} i'_{rd} \\ i'_{rq} \\ i'_{r0} \end{Bmatrix} \end{aligned} \right\}, \quad (38b)$$

where

$$L_m = \frac{3}{2} L_{ms}.$$

Figure 2 shows the equivalent diagrams corresponding to expressions (38a) and (38b).

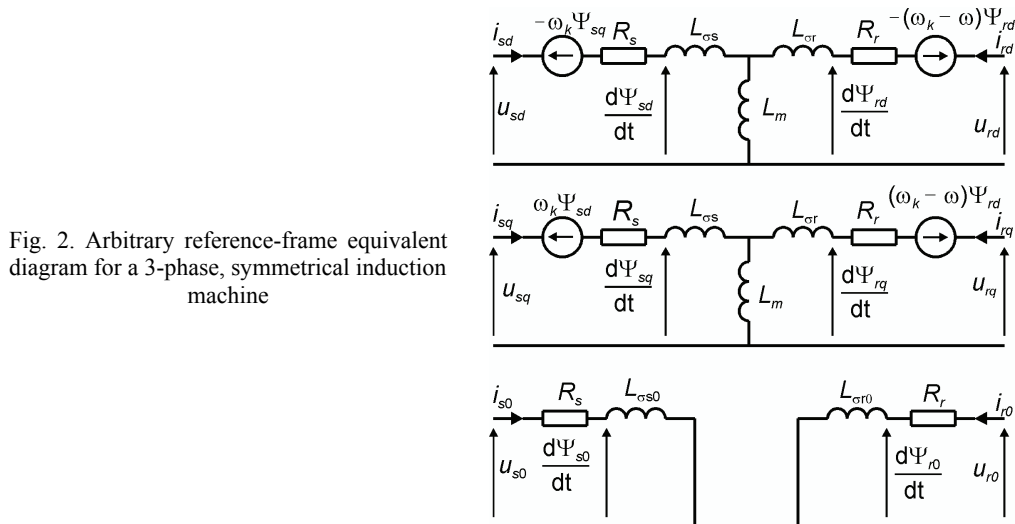

Fig. 2. Arbitrary reference-frame equivalent diagram for a 3-phase, symmetrical induction machine

Electromagnetic torque in the common reference frame $dq0$ is determined by dependence [1, 6, 7]

$$T_e = \frac{3}{2} p_b L_m (i_{rd} i_{sq} - i_{rq} i_{sd}). \quad (39)$$

4. Determination of slot leakage inductance of double-layer winding

In the double-layer winding there are slots which are situated in upper and lower layer the coil sides. One side of the coil is located in the bottom layer of a slot and the second side of the coil is located upper the slot. In the case of double-layer windings we can distinguish the slots, in which the lower and upper layers are with different phases. Figure 3 shows the distribution of coil wires in the slots of stator of the three-phase induction motor of stator with slot number $Q_s = 18$, the number of pole pairs $p = 1$, the number of slots per pole and phase $q_s = 3$ and short pitch $y_s = 7/9$.

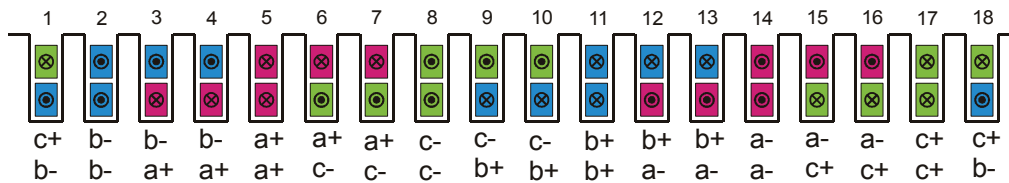

Fig. 3. Arrangement of coil sides of a double-layer windings with short pitch $y_s = 7/9$

Slot leakage inductance is determined by the following simplifying assumptions:

- magnetic permeability of ferromagnetic material surrounding the slot is equal to infinity,
- distribution of the magnetic field lines along the width of slot is straight.

Slot leakage inductance is determined from the magnetic leakage flux energy stored in all slots. If the magnetic field strength changes along slot height, then magnetic field strength, according to the designations in Figure 4, is calculated from the following dependencies

$$W_m = \frac{1}{2} \mu_0 b_s l_e \int_0^{h_Q} H_x^2(y) dy. \quad (40)$$

Magnetic energy of an individual slot is the sum of magnetic energies of slot part (Fig. 4).

$$W_{mQ} = \frac{1}{2} \mu_0 b_s l_e \left\{ \int_0^{h_d} H_{x4}^2(y) dy + \int_{h_d}^{h_d+h_i+h_d} H_{x3}^2(y) dy + \int_{h_d+h_i+h_d}^{h_d+h_i+h_d+h_g} H_{x2}^2(y) dy + \int_{h_d+h_i+h_d+h_g}^{h_d+h_i+h_d+h_g+h_s} H_{x1}^2(y) dy \right\} \quad (41)$$

Fig. 4. Cross-section of a slot with coil sides for a double-layer windings with main dimensions to calculate the slot leakage inductance

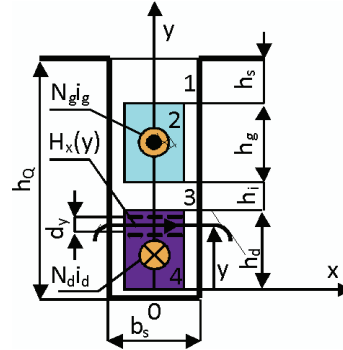

Magnetic field strength of each slot part filled only with phase winding a ($i_d = i_g = i_a$) is equal to

- in part 4

$$\underline{H}_{x4}(y) = \frac{N_d i_a}{b_s} \frac{y}{h_d} \quad \text{for } 0 \leq y \leq h_d, \quad (42)$$

- in part 3

$$\underline{H}_{x3}(y) = \frac{N_d i_a}{b_s} \quad \text{for } h_d \leq y \leq h_d + h_i, \quad (43)$$

- in part 2

$$\underline{H}_{x2}(y) = \frac{N_d i_a}{b_s} + \frac{N_g i_a}{b_s} \frac{y - h_g - h_i}{h_g} \quad \text{for } h_d + h_i \leq y \leq h_d + h_i + h_g, \quad (44)$$

- in part 1

$$\underline{H}_{x1}(y) = \frac{N_d i_a}{b_s} + \frac{N_g i_a}{b_s} \quad \text{for } h_d + h_i + h_g \leq y \leq h_d + h_i + h_g + h_s. \quad (45)$$

The total magnetic energy of a single slot, filled only with phase winding a is equal to

$$W_{maQ} = \frac{1}{2} \mu_0 l_e N_c^2 \left\{ \left(\frac{N_d}{N_c} \right)^2 \left(\frac{h_d}{3b_s} + \frac{h_g}{b_s} + \frac{h_i}{b_s} + \frac{h_s}{b_s} \right) + \left(\frac{N_g}{N_c} \right)^2 \left(\frac{h_g}{3b_s} + \frac{h_s}{b_s} \right) + \right. \\ \left. + 2 \frac{N_d}{N_c} \frac{N_g}{N_c} \left(\frac{h_g}{2b_s} + \frac{h_s}{b_s} \right) \right\} i_a^2. \quad (46)$$

Analogous expressions are obtained if the slot is filled in only with phase winding b or c . Number of slots with conductors carrying the currents of the same winding phase is equal to

$$Q_s \left(y_s - \frac{2}{3} \right).$$

Therefore, the total magnetic energy associated with slots where the coil currents concern the same phases (Fig. 1)

$$W_{ma,b,c} = \frac{1}{2} \mu_0 l_e N_c^2 Q_s \left(y_s - \frac{2}{3} \right) \cdot \left\{ \left(\frac{N_d}{N_c} \right)^2 \left(\frac{h_d}{3b_s} + \frac{h_g}{b_s} + \frac{h_i}{b_s} + \frac{h_s}{b_s} \right) + \left(\frac{N_g}{N_c} \right)^2 \left(\frac{h_g}{3b_s} + \frac{h_s}{b_s} \right) + 2 \frac{N_d}{N_c} \frac{N_g}{N_c} \left(\frac{h_g}{2b_s} + \frac{h_s}{b_s} \right) \right\} (i_a^2 + i_b^2 + i_c^2) \quad (47)$$

If the slot which contains the sides of coils with different phases and oriented with different directions, wherein the lower layer includes phase sides a and the upper layer include the phase b , the magnetic energy of a single slot is calculated from the following dependencies

$$W_{mQab} = \frac{1}{2} \mu_0 l_e N_c^2 \left\{ \left(\frac{N_d}{N_c} \right)^2 \left(\frac{h_d}{3b_s} + \frac{h_g}{b_s} + \frac{h_i}{b_s} + \frac{h_s}{b_s} \right) i_a^2 + \left(\frac{N_g}{N_c} \right)^2 \left(\frac{h_g}{3b_s} + \frac{h_s}{b_s} \right) i_b^2 - 2 \frac{N_d}{N_c} \frac{N_g}{N_c} \left(\frac{h_g}{2b_s} + \frac{h_s}{b_s} \right) i_a i_b \right\} \quad (48)$$

Similar dependencies are obtained if the lower layer contains the phase c current, while the upper layer contains the phase current a

$$W_{mQca} = \frac{1}{2} \mu_0 l_e N_c^2 \left\{ \left(\frac{N_d}{N_c} \right)^2 \left(\frac{h_d}{3b_s} + \frac{h_g}{b_s} + \frac{h_i}{b_s} + \frac{h_s}{b_s} \right) i_c^2 + \left(\frac{N_g}{N_c} \right)^2 \left(\frac{h_g}{3b_s} + \frac{h_s}{b_s} \right) i_a^2 - 2 \frac{N_d}{N_c} \frac{N_g}{N_c} \left(\frac{h_g}{2b_s} + \frac{h_s}{b_s} \right) i_c i_a \right\} \quad (49)$$

When the lower layer contains the phase b current and the top layer has the phase current a

$$W_{mQbc} = \frac{1}{2} \mu_0 l_e N_c^2 \left\{ \left(\frac{N_d}{N_c} \right)^2 \left(\frac{h_d}{3b_s} + \frac{h_g}{b_s} + \frac{h_i}{b_s} + \frac{h_s}{b_s} \right) i_b^2 + \left(\frac{N_g}{N_c} \right)^2 \left(\frac{h_g}{3b_s} + \frac{h_s}{b_s} \right) i_c^2 - 2 \frac{N_d}{N_c} \frac{N_g}{N_c} \left(\frac{h_g}{2b_s} + \frac{h_s}{b_s} \right) i_b i_c \right\} \quad (50)$$

The wires inside slots have the coil sides oppositely directed and the coil sides of particular phase occupy only the lower layer. The wire number is to $Q_s(1 - y_s)$. Thus, the magnetic energy of slots with different phase sides is equal to

$$W_{mab, bc, ca} = \frac{1}{2} \mu_0 l_e N_c^2 Q_s (1 - y_s) \cdot \left\{ \left[\left(\frac{N_d}{N_c} \right)^2 \left(\frac{h_d}{3b_s} + \frac{h_g}{b_s} + \frac{h_i}{b_s} + \frac{h_s}{b_s} \right) + \left(\frac{N_g}{N_c} \right)^2 \left(\frac{h_g}{3b_s} + \frac{h_s}{b_s} \right) \right] (i_a^2 + i_b^2 + i_c^2) \right. \\ \left. - 2 \frac{N_d}{N_c} \frac{N_g}{N_c} \left(\frac{h_g}{2b_s} + \frac{h_s}{b_s} \right) (i_a i_b + i_b i_c + i_c i_a) \right\} \quad (51)$$

Total magnetic energy stored in all stator slots is determined by the expression

$$W_m = \frac{1}{2} \mu_0 l_e N_c^2 Q_s \left\{ \frac{1}{3} \left(\frac{N_d}{N_c} \right)^2 \left(\frac{h_d}{3b_s} + \frac{h_g}{b_s} + \frac{h_i}{b_s} + \frac{h_s}{b_s} \right) \right. \\ \left. + \frac{1}{3} \left(\frac{N_g}{N_c} \right)^2 \left(\frac{h_g}{3b_s} + \frac{h_s}{b_s} \right) + \right. \\ \left. + 2 \frac{N_d}{N_c} \frac{N_g}{N_c} \left(\frac{h_g}{2b_s} + \frac{h_s}{b_s} \right) \left(y_s - \frac{2}{3} \right) \right\} (i_a^2 + i_b^2 + i_c^2) + \\ - \mu_0 l_e N_c^2 Q_s (1 - y_s) \left\{ \frac{N_d}{N_c} \frac{N_g}{N_c} \left(\frac{h_g}{2b_s} + \frac{h_s}{b_s} \right) (i_a i_b + i_b i_c + i_c i_a) \right\}. \quad (52)$$

The resultant slot leakage self inductance $L_{Q\sigma}$ and mutual inductance $L_{Qm\sigma}$ can be calculated from the energy balance of the magnetic field leakage in all Q_s stator's slots. This energy can be represented as [7]

$$W_m = \frac{1}{2} \{ i_a \ i_b \ i_c \} \begin{bmatrix} L_{Q\sigma} & L_{Qm\sigma} & L_{Qm\sigma} \\ L_{Qm\sigma} & L_{Q\sigma} & L_{Qm\sigma} \\ L_{Qm\sigma} & L_{Qm\sigma} & L_{Q\sigma} \end{bmatrix} \begin{Bmatrix} i_a \\ i_b \\ i_c \end{Bmatrix} = \\ = \frac{1}{2} L_{Q\sigma} (i_a^2 + i_b^2 + i_c^2) + L_{Qm\sigma} (i_a i_b + i_b i_c + i_c i_a). \quad (53)$$

The comparison of dependencies (52) and (53) results in self- and mutual inductance of slot leakage flux with double-layer short pitch winding

$$L_{Q\sigma} = \mu_0 l_e N_c^2 Q_s \left\{ \frac{1}{3} \left(\frac{N_d}{N_c} \right)^2 \left(\frac{h_d}{3b_s} + \frac{h_g}{b_s} + \frac{h_i}{b_s} + \frac{h_s}{b_s} \right) + \frac{1}{3} \left(\frac{N_g}{N_c} \right)^2 \left(\frac{h_g}{3b_s} + \frac{h_s}{b_s} \right) + \right. \\ \left. + 2 \frac{N_d}{N_c} \frac{N_g}{N_c} \left(\frac{h_g}{2b_s} + \frac{h_s}{b_s} \right) \left(y_s - \frac{2}{3} \right) \right\} \quad (54)$$

$$L_{Qm\sigma} = -\mu_0 l_e N_c^2 Q_s (1 - y_s) \frac{N_d}{N_c} \frac{N_g}{N_c} \left\{ \frac{h_g}{2b_s} + \frac{h_s}{b_s} \right\}. \quad (55)$$

Taking into consideration the expressions

$$Q = 6pq_s, \quad N_c = \frac{N_s}{pq_s} \quad (56)$$

and taking into account that for the double-layer winding $h_d = h_g = h_c/2$ as well as $N_d = N_g = N_c/2$, the expression for self- and mutual slot leakage inductance can be written as

$$L_{Q\sigma} = 2\mu_0 l_e \frac{N_c^2}{pq_s} \left\{ \frac{h_c}{3b_s} k_{Q1} + \frac{h_i}{4b_s} + \frac{h_s}{b_s} k_{Q2} \right\}, \quad (57)$$

$$L_{Qm\sigma} = -2\mu_0 l_e \frac{N_s^2}{pq_s} \left\{ \frac{h_c}{3b_s} k_{m1} + \frac{h_s}{b_s} k_{m2} \right\}, \quad (58)$$

where the coefficients k_{Q1} , k_{Q2} and k_{m1} , k_{m2} are determined by the following formulas

$$\left. \begin{aligned} k_{Q1} &= \frac{9}{8} y_s - \frac{1}{8} & k_{Q2} &= \frac{3}{2} y_s - \frac{1}{2} \\ k_{m1} &= \frac{9}{16} - \frac{9}{16} y_s & k_{m2} &= \frac{3}{4} - \frac{3}{4} y_s \end{aligned} \right\} \quad (59)$$

Slot leakage inductance for components d , q as well as the zero sequence component (according to dependence (37)) can be written as

$$L_{\sigma} = L_{Q\sigma} - L_{Qm\sigma} = 2\mu_0 l_e \frac{N_s^2}{pq_s} \left\{ \frac{h_c}{3b_s} k_1 + \frac{h_i}{4b_s} + \frac{h_s}{b_s} k_2 \right\}, \quad (60)$$

$$L_{\sigma 0} = L_{Q\sigma} + 2L_{Qm\sigma} = 2\mu_0 l_e \frac{N_s^2}{pq_s} \left\{ \frac{h_c}{3b_s} k_{02} + \frac{h_i}{4b_s} + \frac{h_s}{b_s} k_{02} \right\}, \quad (61)$$

where the coefficients k_1 and k_2 and k_{01} and k_{02} are given by the following formulas

$$\left. \begin{aligned} k_1 &= \frac{9}{16} y_s + \frac{7}{16}, & k_2 &= \frac{3}{4} y_s + \frac{1}{4}, \\ k_{01} &= \frac{27}{16} y_s - \frac{11}{16}, & k_{02} &= \frac{9}{4} y_s - \frac{5}{4} \end{aligned} \right\} \quad (62)$$

The values of the factors for self inductances k_{Q1} and k_{Q2} and mutual inductances k_{m1} and k_{m2} of slot leakage for double-layer winding are given in Figure 5. Figure 6 shows the values of factors k_1 and k_2 for the dq components, and coefficients k_{01} and k_{02} for zero sequence component.

Fig. 5. The factors k_{Q1} , k_{Q2} and k_{m1} , k_{m2} of coil vs the span y_s values

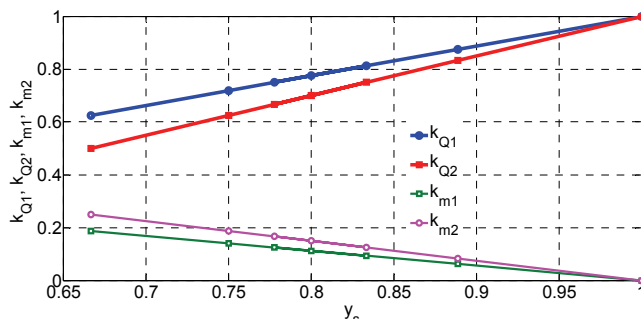
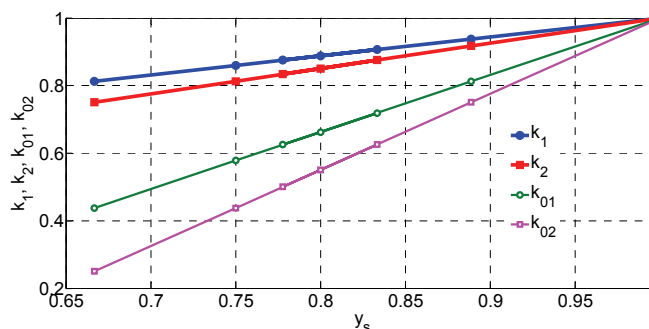

Fig. 6. The factors k_1 and k_2 for coil vs the span y_s values



5. Determination of slot leakage inductance for delta winding

Location of delta winding in each stator slot are presented in Figure 7. The winding is characterized by delta distribution of the linear density of the current [2].

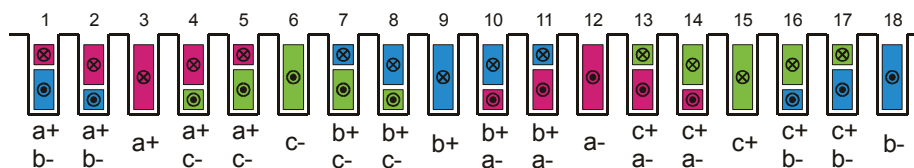

Fig. 7. Arrangement of the coil sides for delta winding with the number of slots per pole and phase $q_s = 3$ and the number of pole pairs $p = 2$

A sketch of a slot with coil sides for delta connecting of the winding with main dimensions to calculate the slot leakage inductance is shown in Figure 8.

The magnetic field strength for particular slot parts for k -of slot, wherein $k = 1, 2, \dots, q_s - 1$, according to the designations in Figure 8, is calculated from the following dependencies

- in part 4 (lower part of a slot – current flows i_b)

$$\underline{H}_{x4}(y) = \frac{\frac{q-k}{q} N_c i_b}{b_s} \frac{y}{\frac{q-k}{q} h_c} \quad \text{for } 0 \leq y \leq \frac{q-k}{q} h_c, \quad (63)$$

- in part 3

$$\underline{H}_{x3}(y) = \frac{\frac{q-k}{q} N_c i_b}{b_s} \quad \text{for } \frac{q-k}{q} h_c \leq y \leq \frac{q-k}{q} h_c + h_i, \quad (64)$$

- in part 2

$$\underline{H}_{x2}(y) = \frac{\frac{q-k}{q} N_c i_b}{b_s} + \frac{\frac{k}{q_s} N_c i_a}{\frac{k}{q_s} h_c} \frac{y}{\frac{k}{q_s} h_c} \quad \text{for } \frac{q-k}{q} h_c + h_i \leq y \leq \frac{q-k}{q} h_c + h_i + \frac{k}{q_s} h_c, \quad (65)$$

- in part 1

$$\underline{H}_{x1}(y) = \frac{\frac{q-k}{q} N_c i_b}{b_s} + \frac{\frac{k}{q_s} N_c i_a}{\frac{k}{q_s} h_c} \quad \text{for } \frac{q-k}{q} h_c + h_i + \frac{k}{q_s} h_c \leq y \leq \frac{q-k}{q} h_c + h_i + \frac{k}{q_s} h_c + h_s, \quad (66)$$

where: h_c – the height of the slot occupied by coil sides in the slot.

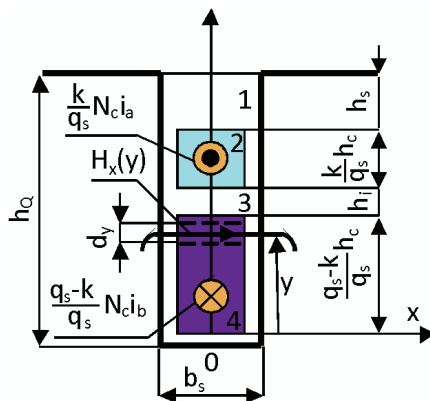

Fig. 8. A sketch of a slot with coil sides of delta winding with main dimensions to calculate the slot leakage inductance ($k = 1, 2, \dots, q_s - 1$)

The magnetic energy of the k -of such slot, which is the sum of the energies of individual slot parts, is determined from the following expressions

$$\begin{aligned}
 W_{Qk} &= W_{m1} + W_{m2} + W_{m3} + W_{m4} = \\
 &= \frac{1}{2} \mu_0 l_e N_c^2 \left\{ \left[\left(\frac{q-k}{q} \right)^3 \frac{h_c}{3b_s} + \left(\frac{q-k}{q} \right)^2 \frac{k h_c}{q b_s} + \left(\frac{q-k}{q} \right)^2 \frac{h_i}{b_s} + \left(\frac{q-k}{q} \right)^2 \frac{h_s}{b_s} \right] i_b^2 + \right. \\
 &\quad \left. + \left[\left(\frac{k}{q} \right)^3 \frac{h_c}{3b_s} + \left(\frac{k}{q} \right)^2 \frac{h_s}{b_s} \right] i_a^2 - 2 \frac{q-k}{q} \left[\left(\frac{k}{q} \right)^2 \frac{h_c}{2b_s} i_a i_b + \frac{k h_s}{q b_s} \right] i_a i_b \right\}. \quad (67)
 \end{aligned}$$

Magnetic energy for slot $4q-k$ is calculated in the same way as for k slot exchanging current i_a with current i_b

$$\begin{aligned}
 W_{Q(4q-k)} &= W_{m1} + W_{m2} + W_{m3} + W_{m4} = \\
 &= \frac{1}{2} \mu_0 l_e N_c^2 \left\{ \left[\left(\frac{q-k}{q} \right)^3 \frac{h_c}{3b_s} + \left(\frac{q-k}{q} \right)^2 \frac{k h_c}{q b_s} + \left(\frac{q-k}{q} \right)^2 \frac{h_i}{b_s} + \left(\frac{q-k}{q} \right)^2 \frac{h_s}{b_s} \right] i_a^2 + \right. \\
 &\quad \left. + \left[\left(\frac{k}{q} \right)^3 \frac{h_c}{3b_s} + \left(\frac{k}{q} \right)^2 \frac{h_s}{b_s} \right] i_b^2 - 2 \frac{q-k}{q} \left[\left(\frac{k}{q} \right)^2 \frac{h_c}{2b_s} i_a i_b + \frac{k h_s}{q b_s} \right] i_a i_b \right\}. \quad (68)
 \end{aligned}$$

Total magnetic energy for k -of such slot and for slot $(4q-k)$ is equal to

$$\begin{aligned}
 W_{Qk,(4q-k)} &= W_{Qk} + W_{Q(4q-k)} = \frac{1}{2} \mu_0 l_e N_c^2 \cdot \\
 &\left\{ \left[\left(\left(\frac{q-k}{q} \right)^3 + 3 \left(\frac{q-k}{q} \right)^2 \frac{1}{q} + \left(\frac{k}{q} \right)^3 \right) \frac{h_c}{3b_s} + \left(\frac{q-k}{q} \right)^2 \frac{h_i}{b_s} + \left(\left(\frac{q-k}{q} \right)^2 + \left(\frac{k}{q} \right)^2 \right) \frac{h_s}{b_s} \right] (i_a^2 + i_b^2) \right. \\
 &\quad \left. - 4 \frac{q-k}{q} \left[\left(\frac{k}{q} \right)^2 \frac{h_c}{2b_s} + \frac{k h_s}{q b_s} \right] i_a i_b \right\}. \quad (69)
 \end{aligned}$$

The total energy of slots with the currents i_a and i_b is determined by the following dependence

$$\begin{aligned}
 W_{Q(a,b)} &= \frac{1}{2} \mu_0 l_e N_c^2 \cdot \\
 &\cdot \sum_{k=1}^{q-1} \left\{ \left[\left(\left(\frac{q-k}{q} \right)^3 + 3 \left(\frac{q-k}{q} \right)^2 \frac{k}{q} + \left(\frac{k}{q} \right)^3 \right) \frac{h_c}{3b_s} + \left(\frac{q-k}{q} \right)^2 \frac{h_i}{b_s} + \left(\left(\frac{q-k}{q} \right)^2 + \left(\frac{k}{q} \right)^2 \right) \frac{h_s}{b_s} \right] (i_a^2 + i_b^2) \right. \\
 &\quad \left. - 4 \frac{q-k}{q} \left[\left(\frac{k}{q} \right)^2 \frac{h_c}{2b_s} + \frac{k h_s}{q b_s} \right] i_a i_b \right\}. \quad (70)
 \end{aligned}$$

Using expressions of finite series of numbers [12]

$$\left. \begin{aligned} 1 + 2 + \dots + (q-1) &= \frac{q(q-1)}{2} \\ 1^2 + 2^2 + 3^2 + \dots + (q-1)^2 &= \frac{q(q-1)(2q-1)}{6} \\ 1^3 + 2^3 + 3^3 + \dots + (q-1)^3 &= \frac{q^2(q-1)^2}{4} \end{aligned} \right\} \quad (71)$$

and expression (70) we obtain the final form for the total energy

$$W_{Q(a,b)} = \frac{1}{2} \mu_0 l_e N_c^2 \left\{ \begin{aligned} &\left[\frac{(q-1)(3q-1)}{4q} \frac{h_c}{3b_s} + \frac{(q-1)(2q-1)}{6q} \frac{h_i}{b_s} + \frac{(q-1)(2q-1)}{3q} \frac{h_s}{b_s} \right] (i_a^2 + i_b^2) \\ &- 2 \left[\frac{(q-1)(q+1)}{4q} \frac{h_c}{3b_s} + \frac{(q-1)(q+1)}{3q} \frac{h_s}{b_s} \right] i_a i_b \end{aligned} \right\}. \quad (72)$$

Similar dependencies for magnetic energy are given for slots which contain pairs of phase currents (i_b, i_c) and (i_c, i_a)

$$W_{Q(b,c)} = \frac{1}{2} \mu_0 l_e N_c^2 \left\{ \begin{aligned} &\left[\frac{(q-1)(3q-1)}{4q} \frac{h_c}{3b_s} + \frac{(q-1)(2q-1)}{6q} \frac{h_i}{b_s} + \frac{(q-1)(2q-1)}{3q} \frac{h_s}{b_s} \right] (i_b^2 + i_c^2) \\ &- 2 \left[\frac{(q-1)(q+1)}{4q} \frac{h_c}{3b_s} + \frac{(q-1)(q+1)}{3q} \frac{h_s}{b_s} \right] i_b i_c \end{aligned} \right\}, \quad (73)$$

$$W_{Q(c,a)} = \frac{1}{2} \mu_0 l_e N_c^2 \left\{ \begin{aligned} &\left[\frac{(q-1)(3q-1)}{4q} \frac{h_c}{3b_s} + \frac{(q-1)(2q-1)}{6q} \frac{h_i}{b_s} + \frac{(q-1)(2q-1)}{3q} \frac{h_s}{b_s} \right] (i_c^2 + i_a^2) \\ &- 2 \left[\frac{(q-1)(q+1)}{4q} \frac{h_c}{3b_s} + \frac{(q-1)(q+1)}{3q} \frac{h_s}{b_s} \right] i_c i_a \end{aligned} \right\}. \quad (74)$$

The total magnetic energy of slots with the currents of different phases with pair of poles is equal to

$$W_{Q(a,b,c)} = \frac{1}{2} \mu_0 l_e N_c^2 \left\{ \begin{aligned} &\left[\frac{(q-1)(3q-1)}{4q} \frac{h_c}{3b_s} + \frac{(q-1)(2q-1)}{6q} \frac{h_i}{b_s} + \frac{(q-1)(2q-1)}{3q} \frac{h_s}{b_s} \right] (i_a^2 + i_b^2 + i_c^2) \\ &- \left[\frac{(q-1)(q+1)}{4q} \frac{h_c}{3b_s} + \frac{(q-1)(q+1)}{3q} \frac{h_s}{b_s} \right] (i_a i_b + i_b i_c + i_c i_a) \end{aligned} \right\}. \quad (75)$$

The magnetic energy, for slots which contain only windings with current of the same phase (two slots of a particular phase for one pair of poles) and the number of coils N_c in a slot can be calculated from

$$W_{a,b,c} = \frac{1}{2} \mu_0 l_e N_c^2 \left\{ \frac{h_c}{3b_s} + \frac{h_s}{b_s} \right\} (i_a^2 + i_b^2 + i_c^2). \quad (76)$$

When the winding is disposed in two layers in a such slots we obtain

$$W_{a,b,c} = \frac{1}{2} \mu_0 l_e N_c^2 2 \left\{ \frac{h_c}{3b_s} + \frac{h_i}{4b_s} + \frac{h_s}{b_s} \right\} (i_a^2 + i_b^2 + i_c^2). \quad (77)$$

Taking into account the dependencies (75) and (77) total magnetic energy of all slots will be determined by the following dependence

$$W_Q = \frac{1}{2} \mu_0 l_e p N_c^2 2 \left\{ \begin{array}{l} \left[\frac{3q^2 + 1}{4q} \frac{h_c}{3b_s} + \frac{4q^2 - 3q + 2}{3q} \frac{h_i}{4b_s} + \frac{2q^2 + 1}{3q} \frac{h_s}{b_s} \right] (i_a^2 + i_b^2 + i_c^2) \\ - \left[\frac{q^2 - 1}{4q} \frac{h_c}{3b_s} + \frac{q^2 - 1}{3q} \frac{h_s}{b_s} \right] (i_a i_b + i_b i_c + i_c i_a) \end{array} \right\}. \quad (78)$$

From the comparison of equations (53) and (78), and taking into account the expressions (37), we can calculate the self- and mutual slot leakage inductance for delta winding

$$L_{\sigma Q} = 2 \mu_0 l_e \frac{N_s^2}{pq} \left\{ \frac{h_c}{3b_s} k_{Q1} + \frac{h_i}{4b_s} k_{Q3} + \frac{h_s}{b_s} k_{Q2} \right\}, \quad (79)$$

$$L_{\sigma m} = -2 \mu_0 l_e \frac{N_s^2}{pq} \left\{ \frac{h_c}{3b_s} k_{m1} + \frac{h_s}{b_s} k_{m2} \right\}, \quad (80)$$

where the coefficients k_{Q1} , k_{Q2} and k_{Q3} and k_{m1} , k_{m2} are given by the following dependencies

$$\left. \begin{array}{l} k_{Q1} = \frac{3q^2 + 1}{4q^2} \quad k_{Q2} = \frac{2q^2 + 1}{3q^2} \quad k_{Q3} = \frac{4q^2 - 3q + 2}{3q^2} \\ k_{m1} = \frac{q^2 - 1}{8q^2} \quad k_{m2} = \frac{q^2 - 1}{6q^2} \end{array} \right\}. \quad (81)$$

However, slot leakage inductance for components dq and zero sequence component according to (79) and (80) and (37) amounts to

$$L_{\sigma} = 2 \mu_0 l_e \frac{N_s^2}{pq} \left\{ \frac{h_c}{3b_s} k_1 + \frac{h_i}{4b_s} k_3 + \frac{h_s}{b_s} k_2 \right\}, \quad (82)$$

$$L_{\sigma 0s} = 2 \mu_0 l_e \frac{N_s^2}{pq} \left\{ \frac{h_c}{3b_s} k_{01} + \frac{h_i}{4b_s} k_{03} + \frac{h_s}{b_s} k_{02} \right\}. \quad (83)$$

The coefficients k_1 , k_2 and k_{01} , k_{02} are given by the following expressions

$$\left. \begin{array}{l} k_1 = \frac{7q^2 + 1}{8q^2} \quad k_2 = \frac{5q^2 + 1}{6q^2} \quad k_3 = \frac{4q^2 - 3q + 2}{3q^2} \\ k_{01} = \frac{q^2 + 1}{2q^2} \quad k_{02} = \frac{q^2 + 2}{3q^2} \quad k_{03} = \frac{4q^2 - 3q + 2}{3q^2} \end{array} \right\}. \quad (84)$$

the values of self inductance factors k_{Q1} and k_{Q2} as well as the factors for mutual k_{m1} and k_{m2} inductances for the slot leakage of double-layer winding are given in Figure 9. Figure 10 shows the values of the factors k_1 and k_2 for components dq and coefficients k_{01} and k_{02} for zero sequence component.

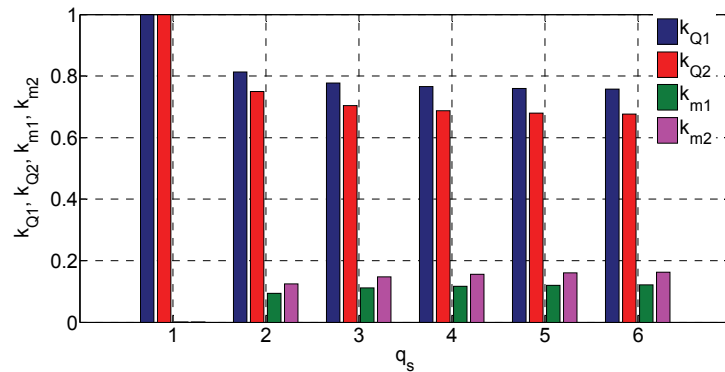

Fig. 9. Factors k_{Q1} , k_{Q2} and k_{m1} , k_{m2} vs the number of slots per pole and phase q_s .

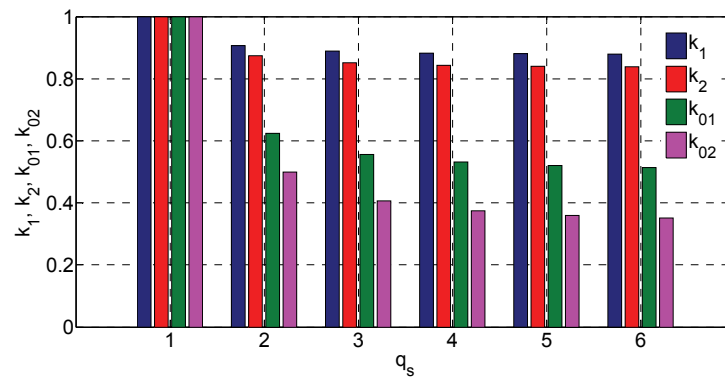

Fig. 10. Factors k_1 and k_2 vs the number of slots per pole and phase q_s .

6. Determination of delta-modified slot leakage inductance

Spatial distribution of linear density of current for delta winding connection is closer to the sinusoidal shape than that obtained for the double-layer winding. Delta winding does not allow to eliminate any harmonic belt spatial frequency components in the magnetic field distribution. For example, the fifth and seventh harmonic components in magnetic field. Delta-modified winding, whose we designed has been patented in [10]. It is characterized by scant higher harmonic spatial content and allows for a significant reduction in the fifth and seventh harmonics as the most significant. The spatial distribution is similar to the sinusoidal one. It is obtained for that winding by reducing the number of wires in the coils of delta winding, which have the maximum number. It concern the coils which are placed in slots 3, 6, 9, 12, 15, 18 in Figure 7. Distribution of delta-modified winding group can be written as

$$\frac{1}{q_s} N_c \quad \frac{2}{q_s} N_c \quad \dots \quad \frac{q_s - 1}{q_s} N_c \quad h N_c \quad \frac{q_s - 1}{q_s} N_c \quad \dots \quad \frac{2}{q_s} N_c \quad \frac{1}{q_s} N_c, \quad (85)$$

where: N_c – maximum number of windings in a slot, q_s – number of slots on the pole and phase.

The coefficient h in the formula (85) comprises a range of $0 < h < 1$, wherein for winding in delta connection we had $h = 1$. By a suitable selection of coefficient h we may obtain distribution of the magnetic field close to a sinusoidal distribution. Rules for the selection of coefficient h are given in the patent description [10]. Magnetic energy of slots, where there are only windings with the same phase (the slots of particular phase per one pair of poles) placed in two layers, with the number of windings hN_c in a slot is equal to

$$W_{a,b,c} = \frac{1}{2} \mu_0 l_e N_c^2 2 \left\{ \frac{h_c}{3b_s} h^2 + \frac{h_i}{4b_s} h^2 + \frac{h_s}{b_s} h^2 \right\} (i_a^2 + i_b^2 + i_c^2). \quad (86)$$

Taking into account the dependencies (75) and (86), the total magnetic energy of all slots for delta-modified winding is determined by the following expressions

$$W_Q = \frac{1}{2} 2\mu_0 l_e \frac{N_c^2}{pq} \cdot \left\{ \left[\frac{3q^2 - 4q(1-h^2) + 1}{4q^2} \frac{h_c}{3b_s} + \frac{4q^2 - 3q(2q-h^2) + 2}{3q^2} \frac{h_i}{4b_s} + \frac{2q^2 - 3q(1-h^2) + 1}{3q^2} \frac{h_s}{b_s} \right] (i_a^2 + i_b^2 + i_c^2) \right. \\ \left. - \left[\frac{(q-1)(q+1)}{4q} \frac{h_c}{3b_s} + \frac{(q-1)(q+1)}{3q} \frac{h_s}{b_s} \right] (i_a i_b + i_b i_c + i_c i_a) \right\}. \quad (87)$$

From comparison of the equations (87) and (53), and taking into account expressions (37), the results for self- and mutual inductance associated with the slot leakage flux for delta-modified winding can be expressed

$$L_{\sigma Q} = 2\mu_0 l_e \frac{N_s^2}{pq} \left\{ \frac{h_c}{3b_s} k_{Q1} + \frac{h_i}{4b_s} k_{Q3} + \frac{h_s}{b_s} k_{Q2} \right\}, \quad (88)$$

$$L_{\sigma m} = -2\mu_0 l_e \frac{N_s^2}{pq} \left\{ \frac{h_c}{3b_s} k_{m1} + \frac{h_s}{b_s} k_{m2} \right\}. \quad (89)$$

Where coefficients k_{Q1} , k_{Q2} and k_{Q3} are described by expressions

$$k_{Q1} = \frac{3q^2 - 4q(1-h^2) + 1}{4q^2}, \quad k_{Q2} = \frac{2q^2 - 3q(1-h^2) + 1}{3q^2}, \quad k_{Q3} = \frac{4q^2 - 3q(2q-h^2) + 2}{3q^2}, \quad (90)$$

however, coefficients k_{m1} and k_{m2} are identical as in delta winding.

Slot leakage inductance for components dq and zero sequence component according to (88) and (89) and (37) will amount to

$$L_{\sigma} = 2\mu_0 l_e \frac{N_s^2}{pq} \left\{ \frac{h_c}{3b_s} k_1 + \frac{h_i}{4b_s} k_3 + \frac{h_s}{b_s} k_2 \right\}, \quad (91)$$

$$L_{\sigma 0s} = 2\mu_0 l_e \frac{N_s^2}{pq} \left\{ \frac{h_c}{3b_s} k_{01} + \frac{h_i}{4b_s} k_{03} + \frac{h_s}{b_s} k_{02} \right\}. \quad (92)$$

Where coefficients k_1 , k_2 and k_{01} , k_{02} are described by

$$\left. \begin{aligned} k_1 &= \frac{7q^2 - 4q(1-h^2) + 1}{8q^2}, & k_2 &= \frac{5q^2 - 3q(1-h^2) + 1}{6q^2}, & k_3 &= \frac{4q^2 - 3q(2q-h^2) + 2}{3q^2}, \\ k_{01} &= \frac{q^2 - 4q(1-h^2) + 1}{2q^2}, & k_{02} &= \frac{q^2 - 3q(1-h^2) + 2}{3q^2}, & k_{03} &= \frac{4q^2 - 3q(2q-h^2) + 2}{3q^2} \end{aligned} \right\}. \quad (93)$$

The procedure for calculating of slot leakage inductance can be simplified under omitting small interlayer insulation thickness h_i between the two sides of the windings in each a slot. As a result of such simplification, the slot leakage inductance can be calculated in the same way as for a single-layer winding, but one should use the two factors taking into account the phase currents reallocation on both sides of the winding in a slot. The coefficient k_1 to the slot part occupied by the winding and the coefficient k_2 to the top of a slot without winding should be taken into account. The slot leakage inductance is then determined from the following expressions

$$\left. \begin{aligned} L_{\sigma Q} &= 2\mu_0 l_e \frac{N_s^2}{pq} (\lambda_{Qa} k_{Q1} + \lambda_{Qb} k_{Q2}) \\ L_{\sigma m} &= -2\mu_0 l_e \frac{N_s^2}{pq} (\lambda_{Qa} k_{m1} + \lambda_{Qb} k_{m2}) \end{aligned} \right\}, \quad (94)$$

$$\left. \begin{aligned} L_{\sigma} &= 2\mu_0 l_e \frac{N_s^2}{pq} (\lambda_{Qa} k_1 + \lambda_{Qb} k_2) \\ L_{\sigma 0s} &= 2\mu_0 l_e \frac{N_s^2}{pq} (\lambda_{Qa} k_{01} + \lambda_{Qb} k_{02}) \end{aligned} \right\}, \quad (95)$$

Magnetic conductivity coefficients λ_{Qa} and λ_{Qb} in the formulas above refer to the single-layer winding of any shape, where in the coefficient λ_{Qa} refers to the slot part comprising the winding and coefficient λ_{Qb} refers to the top of the slot without winding. The coefficients k_{Q1} , k_{Q2} , k_{m1} , k_{m2} , k_1 , k_2 , k_{01} , k_{02} calculated for rectangular slot can also be used to calculate the slot leakage inductance of other shapes [4, 11], committing only a small error. Dependencies on magnetic conductivity coefficients of single-layer windings of any shape, appearing in formulas (94) and (95), can be found in the works [3, 4, 5, 11].

Table 1 shows the values of the coefficients k_1 and k_2 for different types of windings, for $q_s = 3$.

Table 1. Coefficients k_1 and k_2 for different types of windings

k_1	k_2	Type of winding – $q_s = 3$
1	1	single-layer
0.906	0.875	double-layer – $y_s = 5/6$
0.889	0.852	delta
0.845	0.808	delta-modified – $h = 0.858$

7. Conclusions

In this paper, the inductances of the windings for induction motor have been calculated. The dependence of the magnetic field energy on the arrangement of the motor coils is overwritten. For the three-phase current values, the author derived the formulas for the slot leakage inductance of double-layer, delta and delta-modified windings. The method presented in the paper allows to calculate self- and mutual slot leakage inductance of an induction machine in a natural system of coordinate and slot leakage inductance for components dq and zero component. Presented dependencies and graphs show that the placement of the coil in the slot which are belong to different phases causes a reduction in slot leakage inductance in comparison to a single layer winding. Comparing coefficients shown in Table 1, we can state that the greatest reduction in inductance is observed for delta-modified winding, then delta and the smallest one is for the double-layer winding. Developed analytical dependencies may be useful in the design of windings and in the analysis of dynamic states of the AC electric machines.

References

- [1] Boldea I., Nasar S.J., *The Induction Machine Handbook*. CRC Press Boca Raton, London (2002).
- [2] Czaczet J. S., *Electric Micro-machines automation* (in Polish). WNT, Warszawa (1968).
- [3] Dąbrowski M., *Design of AC electrical machines* (in Polish). WNT, Warszawa (1994).
- [4] Głowacki A., *Electromagnetic calculations of three-phase induction motors* (in Polish). WNT, Warszawa (1993).
- [5] Kamiński G., Przyborowski W., *Windings and parameters of electrical machines* (in Polish). Oficyna Wydawnicza Politechniki Warszawskiej, Warszawa (1998).
- [6] Krause P.C., Wasynczuk O., Sudhoff S.D., *Analysis of Electrical Machinery and Drive System* (2nd ed.). IEEE Press, John Wiley & Sons, New York (2002).
- [7] Paszek W., *Dynamics of electric alternating current machines* (in Polish). WNT, Warszawa (1986).
- [8] Pieńkowski K., *Analysis and control of dual stator winding induction motor*. Archives of Electrical Engineering 61(3): 421-438 (2012).
- [9] Sobczyk T.J., *Methodological aspects of mathematical modelling of induction machines* (in Polish). WNT, Warszawa (2004).
- [10] Staszak J., Nadolski R., *Winding of low spatial harmonics in the magnetic field*. PL 213957 B1, Patent Republic of Poland (2012).
- [11] Śliwiński T., *Methods for calculating the induction motors. T. 1, Analysis*. Wydawnictwo Naukowe PWN, Warszawa (2008).
- [12] Zwillinger D., *Standard Mathematical Tables and Formulae*. Chapman & Hall/CRC, Boca Raton – London – New York – Washington (2003).