

Experience in the development and operation of asynchronous turbogenerators and condensers in the Russian Power System

YURY SHAKARYAN, PAVEL SOKUR

*R&D Center of Federal Grid Company
22 bld.3, Kashirskoye Shosse, Moscow, 115201, Russia
e-mail: {shakarian_yg/sokur_pv}@ntc-power.ru*

(Received: 10.09.2014, revised: 18.12.2014)

Abstract: Asynchronous (doubly-fed) machines with two (three) exciting winding and reversing excitation system allow to control vector of magnetomotive force. This solution allows separating regulation of the electromagnetic torque (active power) and voltage (reactive power). This paper describes the experience in the development and operation of asynchronous turbogenerators and condensers.

Key words: asynchronous machine, condenser, doubly-fed machine, reactive power, vector control

1. Introduction

Modern development of electricity networks imposes high requirements for power generators. Such requirements may include:

- high limits of static and dynamic stability;
- ability to operate with the consumption of reactive power;
- ability to operate with variable speed (for wind powered and water powered generators).

The above advantages can be achieved when applying the asynchronous machines (doubly-fed machines).

There are two or three exciting windings placed on the machine rotor. The rotor may be fed with direct or alternating current. Unlike the traditional synchronous machine, there is carried out the vector control of excitation, when independently of each other the electromagnetic torque (active power) and voltage (reactive power) have been adjusted, which enables the stable operation throughout the whole range of operating conditions. When rotor is fed with the alternating currents, the excitation field rotates in reference to the rotor while the synchronism with the stator field has been maintained. As a result, it is possible to operate with variable speed of the turbine, which is important for hydro generators and wind powered generators.

2. Structure of excitation

Structure of direct and quadrature axis excitation and the presence of reversible exciters for each exciting winding enables to orient in the optimal way magnetomotive force (MMF) of generator in order to create a maximum braking electromagnetic torque (Fig. 1) or to rotate MMF vector with reference to the rotor.

Active and reactive power:

$$M = P = \frac{U \cdot E_q}{x} \sin \delta + \frac{U \cdot E_d}{x} \cos \delta, \quad (1)$$

$$Q = -\frac{U^2}{x} + \frac{U \cdot E_q}{x} \cos \delta - \frac{U \cdot E_d}{x} \sin \delta.$$

Control has been carried out as follows:

$$E_d = E_y \cos \delta - E_x \sin \delta, \quad (2)$$

$$E_q = E_y \sin \delta + E_x \cos \delta,$$

where E_x and E_y – specified control laws.

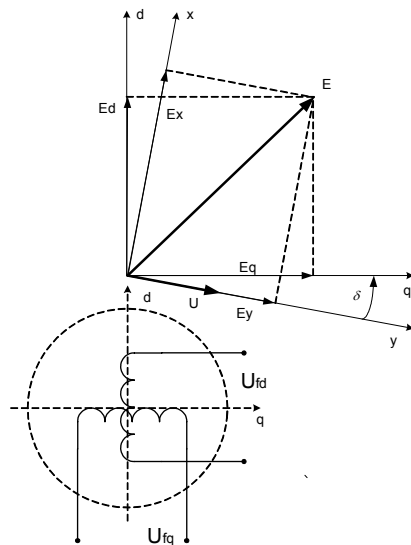

Fig. 1. Attitude position of the exciting windings

Out from (1) & (2) we have:

$$M = P = \frac{U \cdot E_y}{x}, \quad (3)$$

$$Q = -\frac{U^2}{x} + \frac{U \cdot E_x}{x}.$$

Thus, as can be seen from (3) the separate control of electromagnetic torque and voltage (reactive power) is carried out regardless of the current angular position of the rotor.

3. Technical and economic aspects

The world's first asynchronized hydro generator with 50 MVA power and with variable speed ($\pm 1\%$ from synchronous speed) was developed and placed into service in Russia in 1971 on Iovskaya Hydro Power Plant. Further, these generators were widely used on pumped storage power plants (PSPP) in Japan and Europe.

As in Russia, the most part of the electricity is produced by thermal electric power stations, the asynchronized turbogenerators (ASTG) are the most widely used here. Since the turbine generators have massive rotors, the steady state operation with slip is not profitable because there are large losses in the solid rotor. Therefore, at steady state operations, ASTG operate with synchronous rotation speed. Whereas the vector control has been maintained and the exciting windings can have either identical created MMF or different ones.

As we know, in synchronous turbine generators within the underexcited modes there have been introduced the limitation of minimum excitation (LME), which is associated with the increased heating of the end zones of the stator and a significant decrease in stocks of static and dynamic stability.

The matter is settled already with asynchronized turbogenerators, and the diagram of admissible modes in its left side is limited only by the nominal current of the stator. As seen from Figure 2 asynchronized turbogenerators have significantly greater opportunities of control of the reactive power consumption (curve 2, Fig. 2) in comparison with synchronous turbogenerators, in which the consumption mode is limited by LME (curve 4, Fig. 2).

Technical and economic effects of the use of asynchronized turbogenerators is as follows:

- 1) Refusal from additional compensation devices of reactive power (reactors) on station buses.
- 2) Improvement of operation modes for reactive power of synchronous turbine generators of the power plant by eliminating the unfavorable modes with the consumption of reactive power (or close to consumption).
- 3) Increase of the performance reliability of the generating equipment.

Since 1985, there have been put into operation 7 asynchronized turbogenerators ranging from 110 to 320 MW. Experience has shown that asynchronized turbogenerators are in demand in electric power systems and operate within wide range of voltage control, especially in the modes of deep reactive power consumption, which is not achievable by traditional synchronous turbine generators [1]. Voltage change in a wide range is characteristic for non-uniform load diagrams (large cities, industrial plants), as well as for electric power systems with a large number of high voltage cable lines. Figure 3 shows the daily diagrams of reactive power of asynchronized turbogenerators T3FAU-160-2U3 type, 160 MW capacity, operating in Moscow electric power system. As can be seen from the diagrams the reactive power consumption reaches – 160 Mvar.

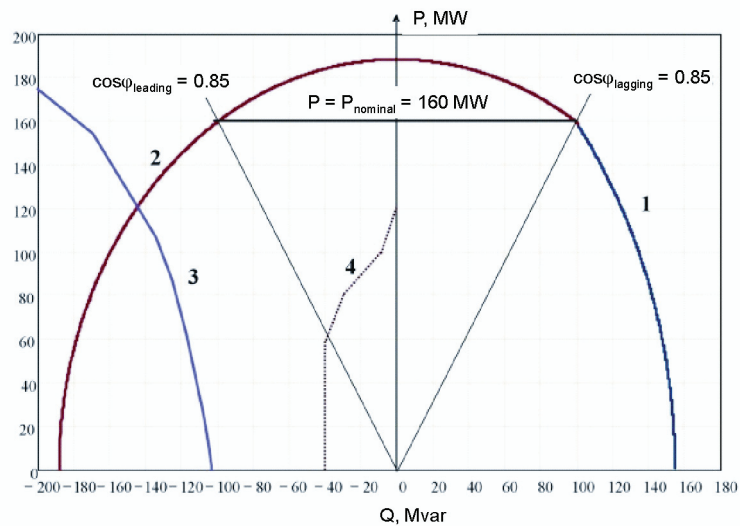

Fig. 2. Diagram of permissible modes of the asynchronous turbogenerator T3FAU-160-2U3. (1 – limitation by the nominal excitation current; 2 – limitation by the nominal current of the stator; 3 – asynchronous characteristics; 4 – LME of synchronous turbogenerator T3FG-160-2U3)

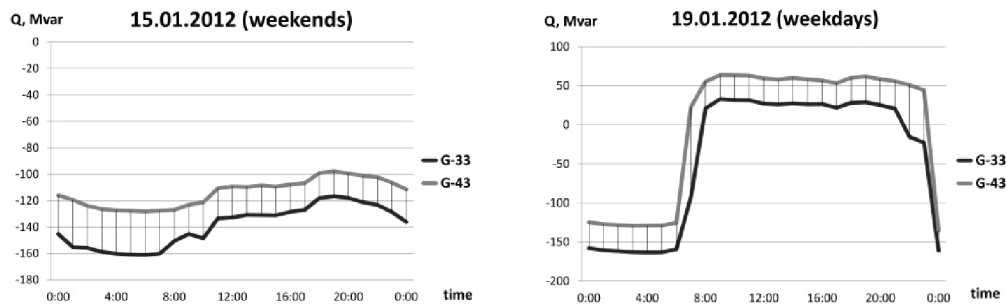

Fig. 3. Daily diagrams of reactive power of asynchronous turbogenerators T3FAU-160-2U3, unit No33 and unit No43, Heat Power Station-27 “Mosenergo” for weekday and weekend.

As known the static var compensators based on power electronics are widely used in electric power system. Along with the undeniable advantages (high speed of operation, no moving parts), they also have disadvantages (harmonic generation, dependence of the output or input reactive power on the voltage at the connection point, inability to carry out short term current (power) overload, without increasing of the specified capacity).

Synchronous condensers withstand short-term double overload that for static devices can be actually achieved only through the doubling of the specified capacity. Resistance to possible surge voltages in lines is also important (for example, due to thunderstorm activity).

At OJSC “Research & development center of Federal Grid Company” together with OJSC “Power Machines” there have been designed, manufactured and put into operation the new type of condensers, ASC-100-4 type with a biaxial excitation and 100 MVA capacity. Asynchronous condenser (ASC) is designed for steady state operation with synchronous rotation

speed. The experience of development of asynchronized turbogenerators was taken into account when designing and manufacturing.

Availability of two exciting windings with excitation system and the above-mentioned vector control provide new features and advantages to such condensers as compared with traditional synchronous condensers with one exciting winding:

- 1) Extended range of reactive power control from +100 Mvar to -100 Mvar (traditional synchronous condensers from +100 Mvar to -40 Mvar).
- 2) Higher control rate of reactive power (voltage) due to the possibility of currents reversal in the exciting windings.
- 3) Improved dynamic performance.
- 4) Improved survivability at the expense of possible operates in standby modes in case of failure in the excitation system. At various failures in the excitation system the condenser can operate in standby modes:
 - with excitation only in the main winding ($-40 \text{ Mvar} < Q < +100 \text{ Mvar}$);
 - asynchronously without excitation ($Q \approx -40 \text{ Mvar}$).

Main technical characteristics of ASC are shown in the Table 1. Two condensers of ASC-100-4 type are installed in Moscow at the substation “Beskudnikovo” (Fig. 4).

Table 1. Technical characteristics of ASC

Parameter name	Value
Nominal power, MVA	100
Reactive power, Mvar	± 100
Stator voltage, kV	20
Stator current, A	2900
Current of rotor windings:	
Along the axis d, A	2200
Along the axis q, A	740
Rotation speed, rotation/minute	1500
Total losses in condenser, kW	1500

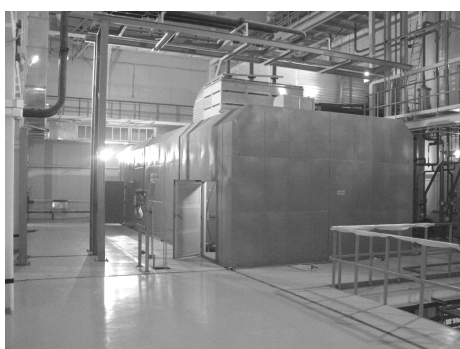

Fig. 4. Asynchronized condenser ASC-100-4 at the substation “Beskudnikovo”

Condenser is fully air cooled, including cooling of bearings oil. For losses tap off, which are evolved in the stator and rotor windings as well as in the magnetic circuit (in the stator core and the rotor shaft) there is provided the direct air cooling of the stator core and indirect air cooling of the stator and rotor windings. Condenser cooling system is an open one with intake of the outer air through the air handling unit and with a partial mix of the hot air in the cold time.

Condenser running out from the rotor standstill, and also stops of the condenser (including emergency mode with minimizing of stop time) is carried out using a static frequency converter.

The excitation current “if” consists of two components: current in the main exciting winding “ifd” and in the control exciting winding “ifq” (Fig. 5). The control exciting winding has fewer turns and smaller nominal current, as compared with the main exciting winding. Control winding MMF is 6% of MMF of the main exciting winding.

As seen from the vector diagram the mode of the deep reactive power consumption (Q) is provided at the expense of the current reversal in the main exciting winding. This ensures high control rate of the reactive power [2].

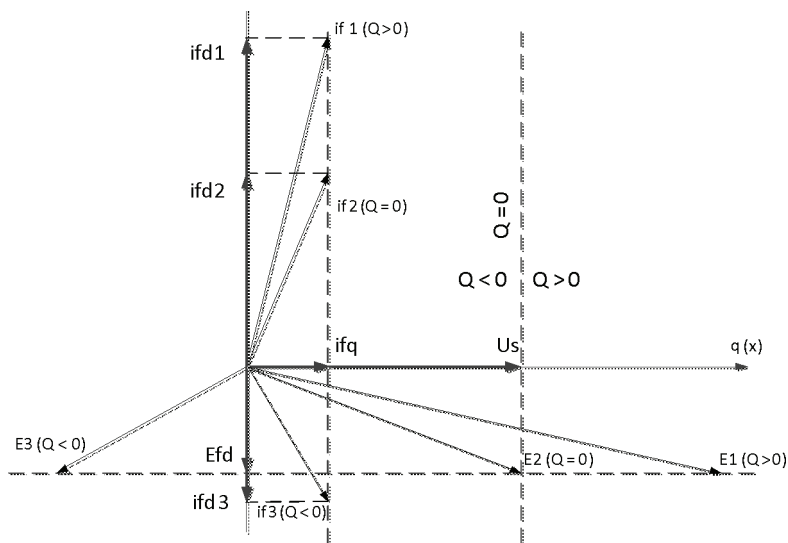

Fig. 5. Vector diagram of ASC-100-4 operation in the modes of output and reactive power consumption

Figure 6 shows the transition process while the reversal of the reactive power of condenser ASC-100-4. During the experiment there was carried out the step change of voltage setting of the automatic voltage regulator (AVR) from the initial value $U = 1,08$ p.u. to $U = 0,91$ p.u. for the time $\Delta t = 60$ s, and then the restoration of the original setpoint. At the chosen values of the voltage setting first the condenser operates in the reactive power output mode ($Q = 1,02$ p.u.) and then in the mode of the deep reactive power consumption ($Q = -0,89$ p.u.) at almost nominal stator current $i \approx 1$ p.u.

Reactive power reversal of the condenser is carried out at the expense of current reversal ifd in the main exciting winding. The angular position of the rotor of ASC at the reversal of the reactive power remains practically unchanged. Reactive power reversing process is dynamically stable. The new value of voltage at generator buses is set in about 0.8 seconds (it does not differ by more than 5% of the setting). Maximum rate of change of condenser reactive power is 300 Mvar /s.

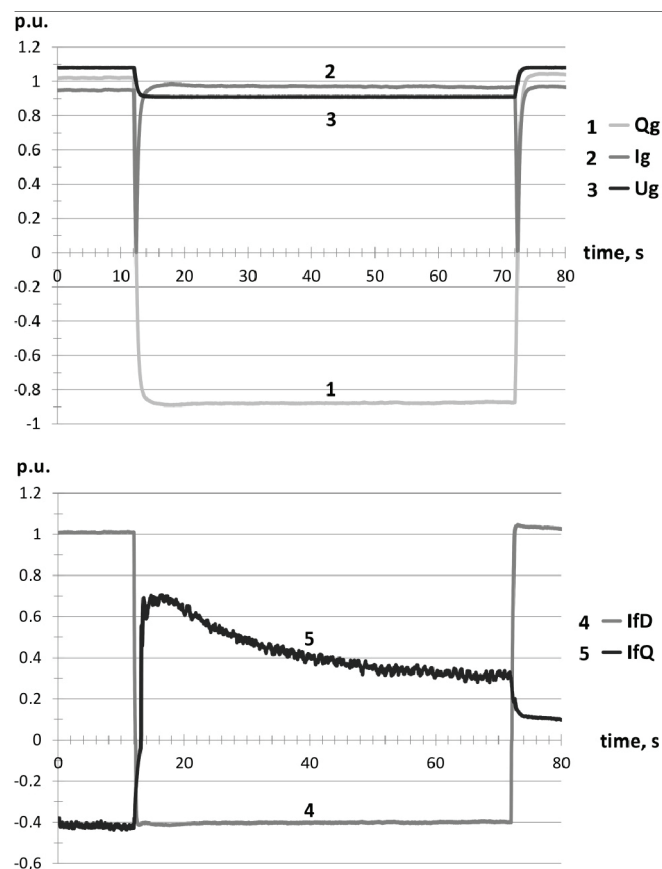

Fig. 6. Reversal of the reactive power of condenser ASC-100-4 (1 – reactive power, 2 – stator current, 3 – stator voltage, 4 – rotor current in the axis d, 5 – rotor current in the axis q)

Since April 2012 two asynchronous condensers ASC-100-4 are in operation on the SS “Beskudnikovo” (Moscow). Figure 7 shows the histogram of the distribution of the number of hours of operate on the ASC-1 by the reactive power for 2012-2013 period. As can be seen from the histogram, the most popular mode of operation is the mode of reactive power consumption from -50 Mvar to -90 Mvar.

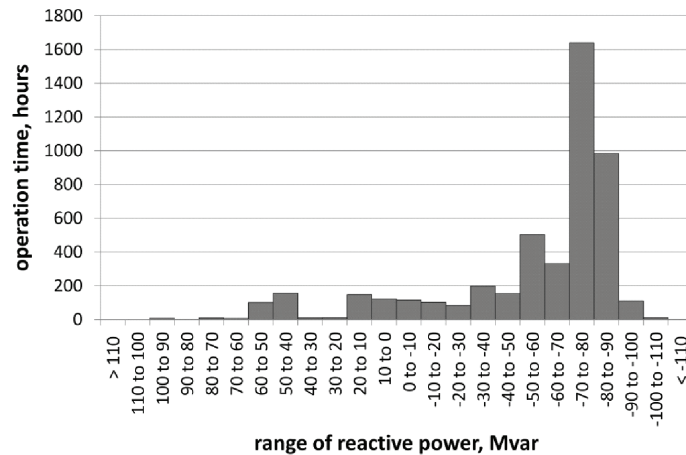

Fig. 7. Histogram of distribution of the number of hours of operate on the ASC-1 by reactive power for 2012-2013 period

4. Conclusions

- 1) Asynchronized machines or doubly-fed machines (generators, condensers, motors) are widely used in modern electric power industry due to the following main advantages:
 - high limits of static and dynamic stability;
 - ability to operate in the modes of deep reactive power consumption;
 - ability to operate with variable speed.
- 2) In Russia there has been set up production and put into operation the asynchronized turbo-generators ranging from 110 to 320 MW. Ability to operate in the modes of deep reactive power consumption allows these generators to control the voltage over a wide range. Technical and economic effect of the use of asynchronized turbogenerators is as follows:
 - refusal from additional compensation devices of reactive power (reactors) on station buses;
 - improvement of operation modes by reactive power of synchronous turbine generators of the power plant at the expense of eliminating of unfavorable modes with the consumption of reactive power (or close to consumption);
 - increase of performance reliability of the generating equipment.
- 3) There has been also set up the production and put into operation the asynchronized condenser with a nominal power of 100 MVA. The availability of two exciting windings with excitation system and vector control provides new features and advantages to such condensers as compared with the traditional synchronous condensers with one exciting winding:
 - extended range of reactive power control from +100% to -100% of nominal power (from +100% to \approx -40% on traditional synchronous condensers);
 - higher control rate of reactive power (voltage) due to the possible reversal of the current in the exciting windings;

- improved dynamic performance;
 - increased survivability at the expense of possible operation in standby modes in case of failure in the excitation system.
- 4) At present, in Russia there has been started the equipping of the PSPPs with asynchronized machines operating with variable speed, as it has been already done in many countries (Japan, Germany, Slovenia, etc.).

References

- [1] Shakaryan Yu.G., Labunets I.A., Sokur P.V. et al., *Experience in using asynchronous turbogenerators in the power stations of Russia*. Power Technology and Engineering 43(6): 389-393, (2009).
- [2] Dovganyuk I.Ya., Labunets I.A., Plotnikova T.V. et al., *The excitation control system of the ASK-100-4 asynchronous compensator*. Power Technology and Engineering 44(4): 327-333 (2010).