

Influence of the Aperture Edge Diffraction Effects on the Mutual Coupling Compensation Technique in Small Planar Antenna Arrays

Mariusz Zamłyński and Piotr Słobodzian

Abstract—In this paper the quality of a technique to compensate for mutual coupling (and other phenomena) in small linear antenna arrays is investigated. The technique consists in calculation of a coupling matrix, which is then used to determine corrected antenna array excitation coefficients. Although the technique is known for more than 20 years, there is still very little information about how different phenomena existing in a real antenna arrays influence its performance. In this paper two models of antenna arrays are used. In the first model the effect of mutual coupling is separated from the aperture edge diffraction. In the second model antenna both mutual coupling and aperture edge diffraction effects are included. It is shown that mutual coupling itself can be compensated very well and an ultralow sidelobe level (i.e. -50 dB) could be achieved in practice. In the presence of diffraction effects -46.3 dB sidelobe level has been attained, but radiation pattern can be controlled only in narrow angle range (i.e. up to $\pm 60^\circ$).

Keywords—Active element, mutual coupling, antenna array, diffraction.

I. INTRODUCTION

THE practical realization of a low sidelobe antenna array is not an easy task. The key problem arises at the stage of antenna array pattern synthesis. The classical, simplified approach to the synthesis, which is based on the pattern multiplication rule [1], can be successfully used only for large antenna arrays or when the antenna radiation pattern shape is not too complicated, and too demanding. The deficiency of the classical approach stems from the simplified antenna array model, which ignores mutual coupling between radiating elements and diffraction by edges of the finite array. In this case the antenna array pattern is expressed in terms of the so-called isolated element pattern. When a low sidelobe level (SLL) and/or deep nulls in desired directions are required the active element pattern should be used in the synthesis [2]. The conventional pattern synthesis techniques (e.g. Chebyshev, Taylor, Villeneuve, etc.) do not take into account the active element pattern and therefore a method for compensation of the aforementioned simplification is required.

Steyskal and Herd [3] proposed one of the most effective methods for compensation of undesired effects. In this method excitation coefficients, obtained by means of the conventional beam synthesis techniques, are multiplied by a coupling matrix, which provides compensation for mutual coupling. Such

approach was validated positively on the experimental way by many researchers [4], [5], [3]. However, the experimental determination of the coupling matrix is burdened with errors originated from diffraction effects and measurement accuracy itself. Once the coupling matrix is determined, its practical implementation within a “non-ideal” feeding network can further decrease (in a random way) the effect of compensation. All these effects introduce some degree of uncertainty into the experimental validation.

In this paper a different approach to the validation of the method for mutual coupling compensation is proposed. In our work an antenna array is modeled in two ways. In the first case, the mutual coupling effects are separated from other undesired phenomena. The separation is obtained by modeling an antenna array over an infinite perfectly conducting ground plane by means of a full wave Method of Moments based software. In this case the influence of diffraction effects on radiation patterns of an antenna array is completely eliminated. In the second case the antenna array is modeled in the presence of aperture edge diffraction, using a finite substrate and ground plane. In addition, an ideal feeding network is modeled as a set of separated voltage sources and impedances to eliminate influence of coupling through the feeding network. Both the antenna array models have been used to verify the quality of the mutual coupling compensation technique and the importance of diffraction effects has been demonstrated.

II. A LINEAR PHASED ARRAY IN THE PRESENCE OF MUTUAL COUPLING

In order to explain the approach to compensation for mutual coupling we will briefly introduce the theory of a linear antenna array in the presence of mutual coupling. We will show only an outline of the theory presented in [3]. The ideal radiation pattern $F_i(u)$ (where $u = \sin(\theta)$) of a linear antenna array, shown in Fig. 1, is given by

$$F_i(u) = f(u) \sum_{m=1}^N a_m \cdot E_m(u) \quad (1)$$

or in an equivalent matrix form as

$$F_i(u) = \mathbf{a}^T \cdot \mathbf{E}(u) \cdot f(u) \quad (2)$$

where $f(u)$ is the isolated element radiation pattern. The excitation coefficients a_m are calculated using the conventional beam synthesis techniques.

M. Zamłyński and P. Słobodzian are with the Institute of Telecommunications, Teleinformatics and Acoustics, Wrocław University of Technology, Janiszewskiego 7/9, 50-372 Wrocław, Poland (e-mails: mariusz.zamlynski@pwr.wroc.pl, piotr.slobodzian@pwr.wroc.pl).

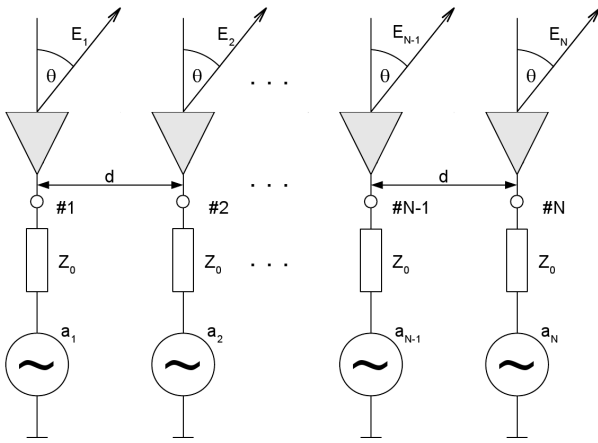
Fig. 1. Geometry of an uniform N element linear array.

In the presence of mutual coupling each radiating element has different radiation pattern, which is measured or simulated in the presence of the remaining array elements and is called the active element radiation pattern. During this measurement/simulation a single element is driven and other elements are terminated in matched loads (Fig. 2).

The active element pattern can be determined using a simplified theoretical model presented by Steyskal and Herd [3]. In this approach it is assumed that a contribution of m -th element to the radiation pattern of n -th element is proportional to the isolated element pattern. In this case, the active element pattern $g_n(u)$ can be expressed by

$$g_n(u) \approx f(u) \sum_{m=1}^N c_{nm} \cdot E_m(u) \quad \text{for } n = 1, \dots, N \quad (3)$$

where c_{nm} is the coupling coefficient and $E_m(u)$ is the incident field at m -th element from direction u . Equation (3) may be expressed in equivalent matrix form as

$$\begin{bmatrix} g_1(u) \\ g_2(u) \\ \vdots \\ g_N(u) \end{bmatrix} \approx \begin{bmatrix} c_{11} & \cdots & c_{1N} \\ c_{21} & \cdots & c_{2N} \\ \vdots & \ddots & \vdots \\ c_{N1} & \cdots & c_{NN} \end{bmatrix} \begin{bmatrix} E_1(u)f(u) \\ E_2(u)f(u) \\ \vdots \\ E_N(u)f(u) \end{bmatrix} \quad (4)$$

or

$$\mathbf{G}(u) \approx \mathbf{C} \cdot \mathbf{E}(u) \cdot f(u) \quad (5)$$

Using (2) and (5) the ideal array radiation pattern can be expressed by

$$F_i(u) \approx F_c(u) = \mathbf{a}^T \cdot \mathbf{C}^{-1} \cdot \mathbf{G}(u) \quad (6)$$

From (6) we can derive the compensated excitation coefficients, namely:

$$\mathbf{a}^s = \mathbf{a}^T \cdot \mathbf{C}^{-1} \quad (7)$$

The central problem of this method is the determination of the unknown coupling matrix \mathbf{C} . There are several methods to solve this problem:

- the Fourier decomposition [4], [6], [3],
- the least-squares approximation method [4],
- the method of moments [5],

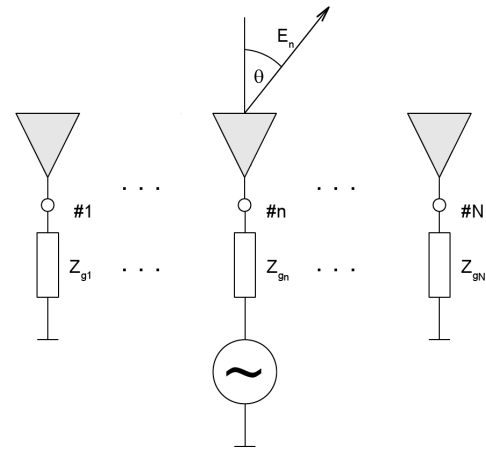

Fig. 2. Geometry for determination of the active element radiation pattern.

- the scattering matrix method [6], [3],
- the beamspace technique [7],
- the QR factorization [8].

In this work we propose a modification of the method described in [5]. As can be seen, equation (3) may be written in the following general form

$$b_n = \sum_{m=1}^N c_{nm} w_m \quad \text{for } n = 1, \dots, N \quad (8)$$

where b_n is the known approximated function and w_m is the weighting function. Both the functions can assume various forms, and several possible variants of these functions have been shown in Table I. The unknown coefficients c_{nm} can be found using the Galerkin method [9], [10], which leads to the following systems of linear equations

$$\mathbf{W} \cdot \mathbf{C}_n = \mathbf{B}_n \quad \text{for } n = 1, \dots, N \quad (9)$$

where

$$\mathbf{W} = \begin{bmatrix} \langle w_1, w_1 \rangle & \cdots & \langle w_N, w_1 \rangle \\ \langle w_1, w_2 \rangle & \cdots & \langle w_N, w_2 \rangle \\ \vdots & \ddots & \vdots \\ \langle w_1, w_N \rangle & \cdots & \langle w_N, w_N \rangle \end{bmatrix} \quad (10)$$

$$\mathbf{C}_n = [c_{n1} \ c_{n2} \ \cdots \ c_{nN}]^T \quad (11)$$

$$\mathbf{B}_n = [\langle b_n, w_1 \rangle \ \langle b_n, w_2 \rangle \ \cdots \ \langle b_n, w_N \rangle]^T \quad (12)$$

Solving for \mathbf{C}_n in (9) gives the approximate solution to (8).

The 1st variant of functions has been proposed and used [5]. This variant provides the best approximation of the active element radiation pattern, but on the other hand, does not guarantee the best solution to the mutual coupling compensation problem. The other variants (2nd – 4th) have been proposed by the authors of this paper, and the 4th variant yields usually better results than the first one, as will be shown in the next section.

TABLE I
DIFFERENT VARIANTS OF THE APPROXIMATED FUNCTION USED TO DETERMINE THE COUPLING COEFFICIENTS

Variant number	Approximated function b_n	Weighting function w_m
1	$g_n(\theta)$	$f(\theta) \cdot E_m(\theta)$
2	$g_n(u)$	$f(u) \cdot E_m(u)$
3	$g_n(\theta)/f(\theta)$	$E_m(\theta)$
4	$g_n(u)/f(u)$	$E_m(u)$

III. VERIFICATION OF THE MUTUAL COUPLING COMPENSATION TECHNIQUE

The model presented in the previous section has been verified based on simulation results of an antenna array obtained by the full-wave FEKO solver. The antenna array used in simulations consists of 8 probe feed microstrip patch elements operating at 2.45 GHz. These elements form a linear array extending in the E-plane (see, Fig. 3). The patch dimensions are $W = 54.36$ mm, $L = 33.98$ mm, $L_f = 10.06$ mm and d is the uniform element spacing. The array has been designed on 1.524 mm thick Isola IS680 ($\epsilon_r = 3$) dielectric substrate, modeled as an infinite layer. The probe diameter is 1 mm. The feed position on a patch element has been optimized to obtain very good impedance matching (for the isolated element). In turn, the active element does not have to be matched to the feeding network, since this does not affect the mutual coupling level.

Mutual coupling between two patches positioned collinearly along the E-plane is presented in Fig. 4. We will use different spacing between adjacent patches of the antenna array to illustrate how the level of mutual coupling influences the technique for mutual coupling compensation. Mutual coupling shown in Fig. 4 has been determined using the scattering matrix parameters as

$$MC_{nm} = \frac{|s_{nm}|^2}{1 - |s_{nn}|^2} \quad (13)$$

This definition removes the effect of impedance mismatching and reflects only the level of power penetrating between patches.

The excitation coefficients for the ideal antenna array were calculated using a Villeneuve technique [11]. Table II shows the best method for mutual coupling compensation for the assumed SLL and the element spacing (refer to Table I for the method designation).

The selection criterion of the best method is based on the

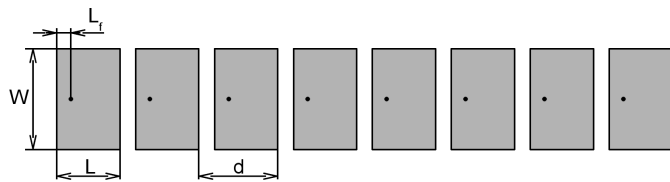

Fig. 3. Geometry of the array used in simulations.

TABLE II
OPTIMAL VARIANT OF THE METHOD FOR MUTUAL COUPLING COMPENSATION

Elements spacing	Optimum method		
	$SLL = -30$ dB	$SLL = -40$ dB	$SLL = -50$ dB
$0.35\lambda_0$	4	4	4
$0.4\lambda_0$	4	4	4
$0.45\lambda_0$	1	4	4
$0.5\lambda_0$	4	4	4
$0.55\lambda_0$	1	4	4
$0.6\lambda_0$	4	4	1
$0.65\lambda_0$	4	4	4
$0.7\lambda_0$	3	3	1

TABLE III
RMS ERROR FOR THE OPTIMAL VARIANT OF THE MUTUAL COUPLING COMPENSATION TECHNIQUE

Elements spacing	RMS Error [dB]		
	$SLL = -30$ dB	$SLL = -40$ dB	$SLL = -50$ dB
$0.35\lambda_0$	0.1029	0.3180	1.3096
$0.4\lambda_0$	0.1620	0.4566	0.8675
$0.45\lambda_0$	0.1742	0.4638	0.6907
$0.5\lambda_0$	0.5626	0.7227	0.9889
$0.55\lambda_0$	0.1265	0.3050	0.7895
$0.6\lambda_0$	0.1600	0.4157	2.7038
$0.65\lambda_0$	0.2850	0.5717	1.5348
$0.7\lambda_0$	0.2184	0.6037	1.6286

RMS error, calculated as

$$RMS = \sqrt{\frac{1}{P} \sum_{p=1}^P er^2(\theta_p)} \quad (14)$$

where

$$er(\theta) = \begin{cases} F_c(\theta) - F_i(\theta) & \text{for } F_i(\theta) > SLL - 30 \\ 0 & \text{for } F_i(\theta) \leq SLL - 30 \end{cases} \quad (15)$$

$F_c(\theta)$ and $F_i(\theta)$ are compensated and ideal antenna array patterns (in dB), respectively. The definition of the error function in (15) is used to make our criterion insensitive to a significant increase in RMS at very deep nulls directions.

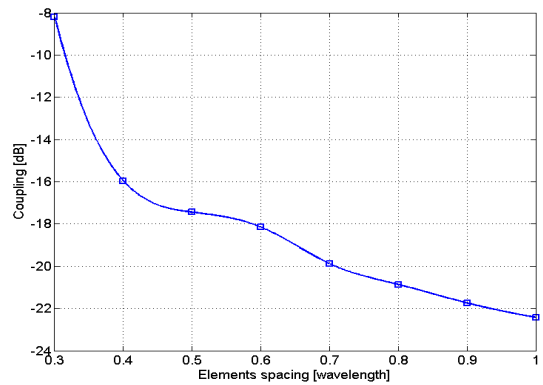

Fig. 4. The E-plane mutual coupling determined between two patches used to build the antenna array.

The results in Table II show that in most cases the best solution is provided by the 4th variant. Since the coupling matrix depends only on physical properties of an antenna array, the optimum variant of the method should be independent of sidelobe level. If this condition is not satisfied then optimum coupling matrices, calculated for different sidelobe levels, are similar. For example, for $0.45\lambda_0$ element spacing and $SLL = -30$ dB the difference between the RMS error for 4th and 1st variant is only 0.0154 dB.

Table III shows the minimum RMS error obtained by variants referred in Table II. Generally, the technique for mutual coupling compensation provides very good results for sidelobe levels as low as -40 dB. A consequence of mutual coupling between radiating elements is that the complex weights (amplitude and phase) applied to every element are in error [5]. Therefore, for ultralow sidelobe levels, such as -50 dB, the RMS error is greater, because such low SLLs require higher accuracy of excitation coefficients [12].

The Galerkin method used to determine the coupling matrix provides a good approximation of the active element radiation pattern (i.e. $g_n(\theta)$) for $-75^\circ < \theta < 75^\circ$. The degradation of mutual coupling compensation results from the fact that the basis functions used in Galerkin's scheme formulation are not suitable beyond that range of angles. This fact is particularly important for $0.5\lambda_0$ elements spacing and causes the RMS error to increase sharply.

A. Results for Infinite Ground Plane

In order to study the effect of mutual coupling on the sidelobe level and the effectiveness of the technique for mutual coupling compensation, radiation patterns for several linear antenna arrays of different geometry were calculated. The radiation pattern of these arrays were calculated using three different methods: multiplication rule (ideal pattern), full wave analysis without excitation coefficients compensation (uncompensated pattern) and full wave analysis with excitation coefficients compensation (compensated pattern). Figures 5 and 6 show examples of ultralow sidelobe level radiation patterns.

The compensation procedure causes equalization of sidelobe level and makes nulls deeper and closer to theoretical ones. If an ideal array pattern contains sidelobes significantly lower than SLL, they will not be restored. For example an array with $0.6\lambda_0$ elements spacing contains a pair of -80 dB sidelobes (see, Fig. 5). Therefore, error of mutual coupling compensation for this antenna array is very high.

Generally, the effect of mutual coupling is weak in antenna arrays with a large element spacing. On the other hand, the discrete array is very sensitive to any distortion. This distortion causes, for example, filled nulls of an uncompensated array pattern (see, Fig. 6).

The mutual coupling effect itself does not cause degradation of the radiation pattern for patch antenna arrays with sidelobe level up to -30 dB and elements spacing greater than $0.4\lambda_0$, because high accuracy of excitation coefficients is not required [12]. For example, the radiation pattern of the array with an element spacing of $0.5\lambda_0$ and $SLL = -30$ dB is presented

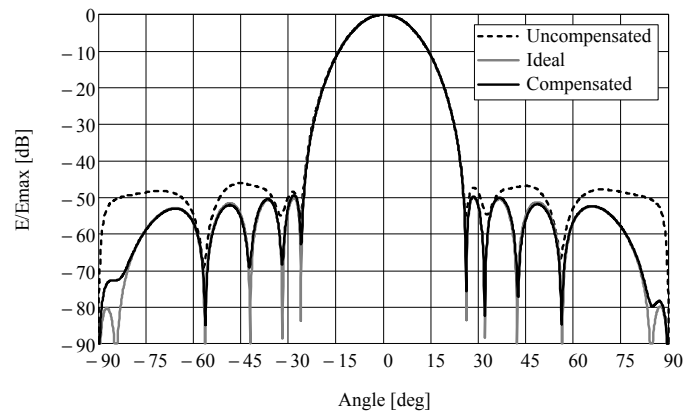

Fig. 5. Comparison of ideal, uncompensated and compensated radiation patterns of the antenna array for $0.6\lambda_0$ elements spacing.

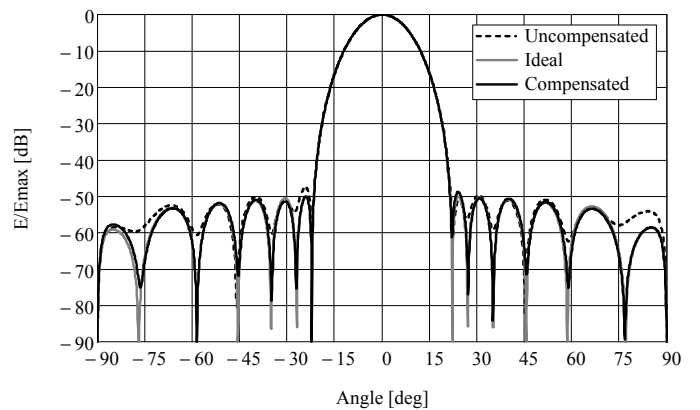

Fig. 6. Comparison of ideal, uncompensated and compensated radiation patterns of the antenna array for $0.7\lambda_0$ elements spacing.

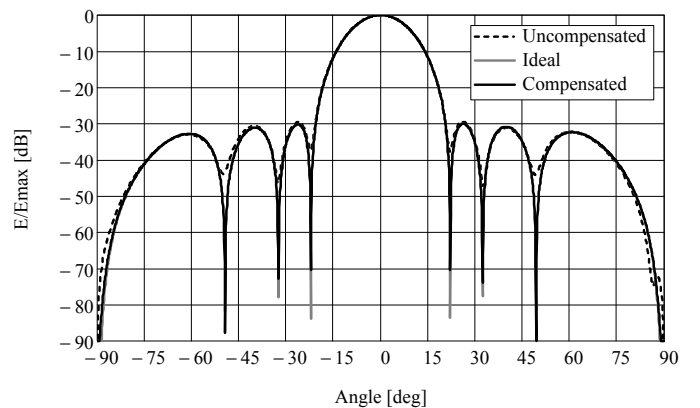

Fig. 7. Comparison of ideal, uncompensated and compensated radiation patterns of the antenna array for $0.5\lambda_0$ elements spacing.

in Fig. 7. The uncompensated radiation pattern contains filled nulls, but the required sidelobe level has been achieved.

IV. INFLUENCE OF DIFFRACTION EFFECTS ON COMPENSATION TECHNIQUE

In a real small planar antenna array the radiation pattern is also distorted by diffraction on the antenna array edges. The technique for mutual coupling compensation, described above,

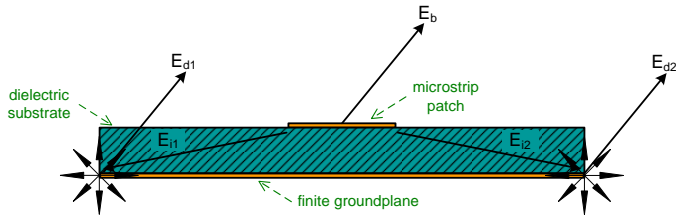

Fig. 8. Simplified visualization of influence of diffraction on radiation pattern of the microstrip patch antenna.

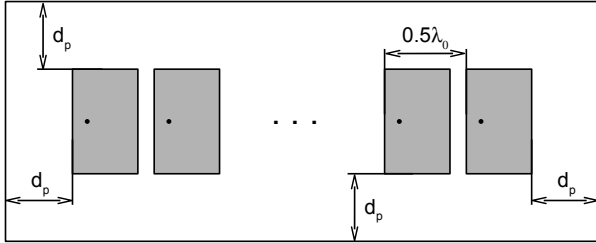

Fig. 9. Geometry of an antenna array over finite ground plane.

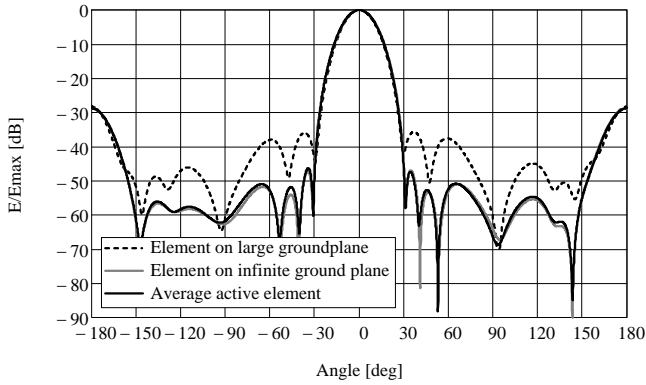

Fig. 10. Comparison of compensated radiation patterns of the antenna array for different isolated radiation patterns, $d_p = 0.25\lambda_0$ and $SLL = -50$ dB.

fails to take the diffraction phenomenon into account. This fact is often pointed out as the main reason for a discrepancy between the expected compensated radiation pattern and the measured one [7], [13], [14].

In general, the total radiation pattern of a single microstrip patch antenna in the presence of diffraction effects may be expressed as [15], [16]

$$E = E_b + E_{d1}(E_{i1}) + E_{d2}(E_{i2}) \quad (16)$$

where E_b is the electric field radiated by the microstrip patch antenna over an infinite ground plane, E_d is the edge diffracted electric field, and E_i is the electric field in points of the diffraction (see, Fig. 8). The radiation pattern of a linear antenna array may be calculated in a similar way.

In order to investigate the influence of diffraction on the performance of the mutual coupling compensation technique a radiation pattern of the antenna array over a finite ground plane has been tested. The antenna array under investigation is shown in Fig. 9. The element spacing d has been set to $0.5\lambda_0$. The distance between edges of the ground plane and the outermost radiating element has been denoted by d_p . In this case the direct application of equation (6) to determine the

TABLE IV
 NORMALIZED EXCITATION COEFFICIENTS OF THE COMPENSATED ANTENNA ARRAYS FOR $d_p = 0.25\lambda_0$ AND $SLL = -50$ dB

No.	Element on large ground plane		Element on infinite ground plane		Average active element	
	Amp. [dB]	Phase [°]	Amp. [dB]	Phase [°]	Amp. [dB]	Phase [°]
1	-16.31	24.86	-20.29	-4.29	-19.83	0.37
2	-8.34	2.84	-9.13	-3.03	-8.83	-0.98
3	-2.47	2.84	-2.67	1.04	-2.58	-1.99
4	-0.16	-2.72	-0.19	-2.82	-0.17	-2.46
5	0	0	0	0	0	0
6	-2.64	1.72	-2.78	0.04	-2.78	-0.16
7	-8.19	5.50	-8.90	0.65	-8.81	0.51
8	-16.16	26.58	-20.00	1.02	-19.77	1.50

compensated antenna array radiation pattern is not so obvious, since the definition of the isolated element is not clear as in the case with an array over an infinite ground plane. In order to mitigate this problem the following definitions of the isolated element can be taken into account:

- a single element placed in the middle of an antenna array ground plane,
- the average active element [7], [17],
- a single element placed over infinite ground plane.

The first definition is intuitive, but the central location of the element results only in a partial contribution to the total diffracted field, and hence is not fully justified. The second definition allows the whole diffraction effects to be indirectly included in the antenna array radiation pattern description. This definition has been successfully applied in [7]. The third definition has been proposed by the authors of this paper. This definition could seem improper since it did not include the diffraction phenomenon. However, the results of analysis have shown that the third definition is equally good as the first one do. It can be shown that a proper choice of the definition of the isolated element has a significant impact on the mutual coupling compensation technique (see, Fig. 10). The radiating element over infinite ground plane and the average active element provide virtually identical compensated radiation patterns (see, Table IV for a comparison of the resulting compensated excitation coefficients).

Also, the results of analysis have confirmed that the size of a ground plane has significant impact on the performance of the mutual coupling compensation technique. When the distance between edges of a ground plane and the outermost radiating elements is very small then the radiation pattern is strongly distorted by the diffraction effects. This phenomenon is clearly visible for pattern angles higher than $\pm 60^\circ$, as can be seen in, Fig. 11 and 12. In this case the ideal radiation pattern of an antenna array (in the presence of the diffraction effects) has been calculated using multiplication rule and the average active element pattern. Radiation patterns of the compensated and uncompensated antenna arrays are almost identical for a small ground plane and angles higher than $\pm 60^\circ$ (see, Fig. 12). This is caused by the fact, that for angles higher than $\pm 60^\circ$ the main contribution to the radiated field comes from

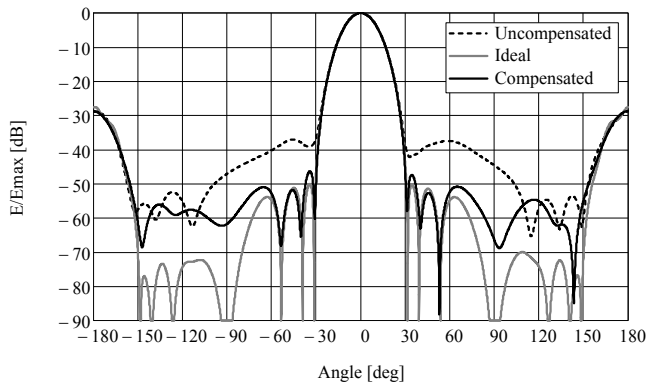

Fig. 11. Comparison of ideal, uncompensated and compensated radiation patterns of the antenna array for $d_p = 0.25\lambda_0$ and $SLL = -50$ dB.

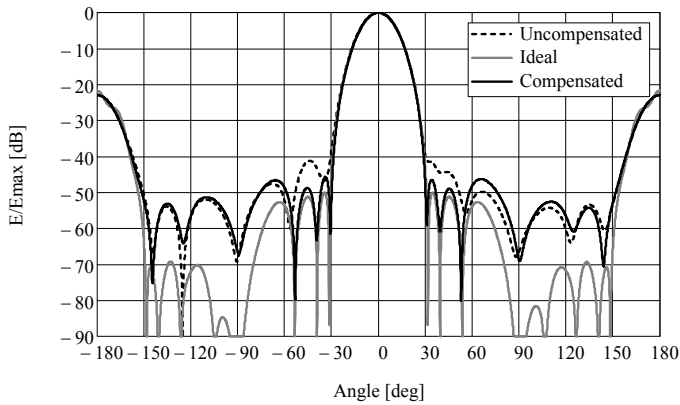

Fig. 12. Comparison of ideal, uncompensated and compensated radiation patterns of the antenna array for $d_p = 0.1\lambda_0$ and $SLL = -50$ dB.

edges of the ground plane. This radiation is not included in the antenna array model described by (3)–(6).

For larger ground planes influence of the diffraction effect is smaller and the compensation technique is more effective due to lower radiation contributed by edges of the finite ground plane. The sidelobe levels of ideal, uncompensated and compensated antenna arrays has been compared in Table V. As we can see, the SLL hardly depends on the size of the ground plane. However, the compensated radiation pattern is closer to the ideal one for larger ground plane.

V. SUMMARY AND FUTURE WORK

A technique to compensate mutual coupling and other phenomena in small antenna arrays was described and verified. The method works very well for arrays whose radiation patterns are not distorted by edge diffraction effects. In this case an ultra low sidelobe level (i.e. -50 dB) can be achieved in a wide range of element spacing in small linear antenna arrays.

It has been shown that the described mutual coupling compensation technique can be also used in presence of the aperture edge diffraction effects. However, only a narrow angular range of the radiation pattern (near the mainlobe) can be controlled. In this case an ultra low sidelobe level (i.e. -46 dB) can be achieved, but the shape of the radiation pattern can not be fully controlled.

TABLE V
COMPARISON OF SLL OF IDEAL, UNCOMPENSATED AND COMPENSATED ANTENNA ARRAYS FOR DIFFERENT GROUND PLANE SIZE

d_p	SLL [dB]		
	Ideal	Uncompensated	Compensated
$0.1\lambda_0$	-30.00	-29.22	-28.88
	-40.00	-36.18	-37.26
	-50.00	-41.22	-45.22
$0.25\lambda_0$	-30.00	-29.66	-30.25
	-40.00	-34.63	-38.87
	-50.00	-36.99	-46.32

Future work will be focused on detailed investigation into the impact of the diffraction effects on the radiation patterns of planar antenna arrays. The aim will be to develop a method for synthesis of small planar antenna array in the presence of mutual coupling and diffraction effects.

REFERENCES

- [1] R. C. Hansen, *Phased Array Antennas*. Wiley-Interscience, 1998.
- [2] D. M. Pozar, "The active element pattern," *IEEE Transactions on Antennas and Propagation*, vol. 42, no. 8, pp. 1176–1178, August 1994.
- [3] H. Steyskal and J. Herd, "Mutual coupling compensation in small array antennas," *IEEE Transactions on Antennas and Propagation*, vol. 38, no. 12, pp. 1971–1975, December 1990.
- [4] R. Borowiec, R. Hossa, P. Slobodzian, and Z. Langowski, "Compensation of mutual coupling in small antenna arrays," in *14th International Conference on Microwaves, Radar and Wireless Communications*, vol. 3, 2002, pp. 894–897.
- [5] P. Darwood, P. Fletcher, and G. Hilton, "Mutual coupling compensation in small planar array antennas," *IEE Proceedings Microwaves, Antennas and Propagation*, vol. 145, no. 1, pp. 1–6, February 1998.
- [6] S. Sadat, C. Ghobadi, and J. Nourinia, "Mutual coupling compensation in small phased array antennas," in *IEEE Antennas and Propagation Society International Symposium*, vol. 4, June 2004, pp. 4128–4131.
- [7] H. Aumann and F. Willwerth, "Phased array calibrations using measured element patterns," in *Antennas and Propagation Society International Symposium*, vol. 2, June 1995, pp. 918–921.
- [8] L. Kuehnke, "Phased array calibration procedures based on measured element patterns," in *Eleventh International Conference on Antennas and Propagation*, vol. 2, 2001, pp. 660–663.
- [9] M. N. O. Sadiku, *Numerical Techniques in Electromagnetics*, 2nd ed. CRC Press, 2000.
- [10] J. Wheless, W. P. and L. T. Wurtz, "Introducing undergraduates to the moment method," *IEEE Transactions on Education*, vol. 38, no. 4, pp. 385–389, November 1995.
- [11] A. Villeneuve, "Taylor patterns for discrete arrays," *IEEE Transactions on Antennas and Propagation*, vol. 32, no. 10, pp. 1089–1093, October 1984.
- [12] D. M. Pozar and B. Kaufman, "Design considerations for low sidelobe microstrip arrays," *IEEE Transactions on Antennas and Propagation*, vol. 38, no. 8, pp. 1176–1185, August 1990.
- [13] A. Bhattacharyya, "Floquet-modal-based analysis for mutual coupling between elements in an array environment," *IEE Proceedings Microwaves, Antennas and Propagation*, vol. 144, no. 6, pp. 491–497, December 1997.
- [14] I. Salonen, A. Toropainen, and P. Vainikainen, "Linear pattern correction in a small microstrip antenna array," *IEEE Transactions on Antennas and Propagation*, vol. 52, no. 2, pp. 578–586, February 2004.
- [15] J. Huang, "The finite ground plane effect on the microstrip antenna radiation patterns," *IEEE Transactions on Antennas and Propagation*, vol. 31, no. 4, pp. 649–653, July 1983.
- [16] R. Kouyoumjian and P. Pathak, "A uniform geometrical theory of diffraction for an edge in a perfectly conducting surface," *Proceedings of the IEEE*, vol. 62, no. 11, pp. 1448–1461, November 1974.
- [17] D. Kelley and W. Stutzman, "Array antenna pattern modeling methods that include mutual coupling effects," *IEEE Transactions on Antennas and Propagation*, vol. 41, no. 12, pp. 1625–1632, December 1993.