

M. POURANVARI*

ON THE FAILURE MODE OF RESISTANCE SPOT WELDED HSLA 420 STEEL**TRYB USZKODZENIA ZGRZEWANYCH SPOIN STALI HSLA 420**

Failure mode of resistance spot welds (interfacial vs. pullout) is a qualitative measure of resistance spot weld performance. Considering adverse effect of interfacial failure mode on the vehicle crashworthiness, process parameters should be adjusted so that the pullout failure mode is guaranteed ensuring reliability of spot welds during vehicle lifetime. In this paper, metallurgical and mechanical properties of HSLA 420 resistance spot welds are studied with particular attention to the failure mode. Results showed that the conventional weld size recommendation of $4t^{0.5}$ (t is sheet thickness) is not sufficient to guarantee pullout failure mode for HSLA steel spot welds during the tensile-shear test. Considering the failure mechanism of spot welds during the tensile-shear test, minimum required fusion zone size to ensure the pullout failure mode was estimated using an analytical model. Fusion zone size proved to be the most important controlling factor for peak load and energy absorption of HSLA 420 resistance spot weld.

Keywords: resistance spot welding, HSLA steel, failure mode, energy absorption

Tryb uszkodzenia zgrzein (pękanie na granicy faz a wrywanie) jest jakościową miarą zachowania zgrzein. Biorąc pod uwagę niekorzystny wpływ uszkodzenia na granicy faz na odporność pojazdu na uderzenia, parametry zgrzewania powinny być ustawione tak, że trybem uszkodzenia jest wrywanie co gwarantuje niezawodność zgrzein w czasie eksploatacji pojazdu. W pracy, badane są metalurgiczne i mechaniczne właściwości zgrzein stali HSLA 420 ze szczególnym uwzględnieniem trybu uszkodzenia. Wyniki próby rozciągania i ścinania wykazały, że konwencjonalne zalecenie rozmiaru spoiny $4t^{0.5}$ (t – grubość) nie jest wystarczające, aby zapewnić że trybem uszkodzenia jest wrywanie. Biorąc pod uwagę mechanizm uszkodzenia zgrzein w czasie próby rozciągania i ścinania, minimalną wielkość strefy stopionej wymaganą do zapewnienia, że trybem uszkodzenia jest najbardziej istotnym czynnikiem decydującym o maksymalnym onciążeniu i pochłanianiu energii przez zgrzewaną stal HSLA 420.

1. Introduction

Weldability of steels is one of the key factors governing their applications in automotive industry [1]. Resistance spot welding is dominant joining process in sheet metal industries particularly automotive industry. Typically, there are about 2000–5000 spot welds in a modern vehicle. Vehicle crashworthiness, which is defined as the capability of a car structure to provide adequate protection to its passengers against injuries in the event of a crash, largely depends on the integrity and the mechanical performance of the spot welds [2-4]. Therefore, spot welds with high load bearing capacity and high energy absorption capability are needed to maximize load transfer and energy dissipation during a car crash. Hence, quality and performance of resistance spot welds (RSWs) are very important for determination of durability and safety design of the vehicles. There are generally three indexes for quality control of resistance spot welds:

(i) Fusion zone size (FZS): FZS which is defined as the width of the weld nugget at the sheet/sheet interface in the lon-

gitudinal direction is the most important factors in determining quality of spot welds [5].

(ii) Weld mechanical performance

Spot weld mechanical performance is generally considered under static/quasi-static and dynamic (fatigue and impact) loading condition. Despite the fact that mechanical performance under dynamic loading is a better performance index than the static test from the point of view of car crashworthiness, static tests are usually used to describe the mechanical behavior of spot welds due to their simplicity. The tensile-shear test is the most widely used test for evaluating the spot weld mechanical behaviors in static condition [5]. Peak load, obtained from the tensile-shear load-displacement curve, is often used to describe spot welds mechanical behaviors. In addition to peak load, failure energy can be used to better describe the spot weld mechanical behaviors. Failure energy is a measure of weld energy absorption capability, and its higher value demonstrates the increase in weld performance reliability against impact loads such as accidents [5,6].

* YOUNG RESEARCHERS CLUB & ELITES, DEZFUL BRANCH, ISLAMIC AZAD UNIVERSITY, DEZFUL, IRAN

(iii) Failure mode

Failure mode is the manner which spot weld fails. Generally, the resistance spot weld (RSW) failure occurs in two modes: interfacial and pullout [7-9]. Fig. 1 shows typical fracture path during mechanical testing of spot weld. In the interfacial mode, failure occurs via crack propagation through fusion zone (Path A); while, in the pullout mode, failure occurs via nugget withdrawal from one sheet. In this mode, fracture may initiate in BM (Path B), HAZ (Path C) or HAZ/FZ (Path D) depending on the base metal and the loading conditions.

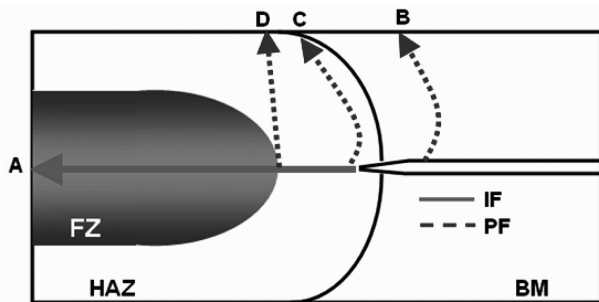

Fig. 1. General fracture path during mechanical testing of resistance spot welds, IF: Interfacial Failure (Path A), PF: Pullout Failure (Path B, Path C and Path D)

Spot weld failure mode is a qualitative measure of the weld quality. Failure mode can significantly affect load bearing capacity and energy absorption capability of RSWs. Generally, the pullout mode is the preferred failure mode due its higher associated plastic deformation and energy absorption. Thus, vehicle crashworthiness, as the main concern in the automotive design, can dramatically reduce if spot welds fail via interfacial mode. The pullout failure mode during quality control indeed indicates that the same weld would have been able to transmit a high level of force, thus cause severe plastic deformation in its adjacent components, and increased strain energy dissipation in crash conditions [10]. Sun et al. [2] concluded that for DP800 and TRIP800 welds, the weld failure mode has very strong influence on both the peak load and the energy. Rivett [11] in his work on RSW of HSLA steels finds that although the force to fail tensile-shear specimens was not influenced by the failure mode, the total failure energy (i.e. the area under load-displacement curve up to final fracture) was significantly larger (250%) for specimens that failed via pullout as compared to those that failed via interfacial mode. Therefore, it is needed to adjust welding parameters so that the pullout failure mode is guaranteed. Sizing of spot weld is usually based on the $4t^{0.5}$ (t is sheet thickness) rule [2,5,9]. However, this criterion does not always give the best result. One can find many evidences in the literature indicating that to ensure the pullout failure mode, a bigger weld nugget diameter is required compared with the values recommended by $4t^{0.5}$ rule. Sawhill et al. [12], Pollard [13] and Vandenberg [14] have demonstrated that to ensure the pullout failure mode for HSLA steels, a bigger weld nugget diameter is required compared with the $4t^{0.5}$ rule.

This paper aims at investigating the microstructure and mechanical properties HSLA420 resistance spot welds. Criti-

cal fusion zone size to ensure nugget pull-out mode during the static tensile shear test is predicted using an analytical model.

2. Experimental procedure

The material used in this study was HSLA 420 high strength low alloy steel. The chemical composition and mechanical properties determined for HSLA 420 are given in Table 1. The sheet thickness of sheets is 1.5 mm.

Spot welding was performed using a 120kVA AC pedestal type resistance spot welding machine operating at 50 Hz, controlled by PLC. Welding was conducted using a 45-deg truncated cone RWMA Class 2 electrode with an 8-mm face diameter. To study the effects of weld FZ size on mechanical properties, spot welding was performed in 12 different welding conditions. Electrode force and electrode holding time after current-off were selected based on the thickness of the base material and were kept constant at 4 kN and 10 cycles. Welding current was changed step by step from 6 to 11.5 kA at welding time of 0.2s. No expulsion was observed during welding using these welding conditions. Four samples were performed per welding condition including three samples for the tensile-shear test and one sample for metallographic investigation.

TABLE 1
Measured chemical composition and mechanical properties of investigated HSLA 420 steel

Chemical Composition (wt%)					Tensile Properties	
C	Mn	Si	V	Nb	UTS*(MPa)	EL** (%)
0.08	0.72	0.14	0.16	0.18	510	26

* Ultimate tensile strength

** Elongation

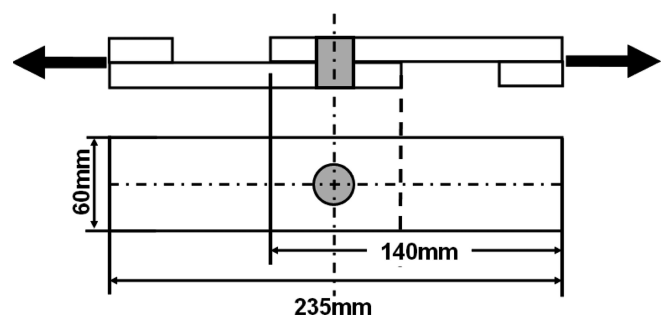

Fig. 2. Tensile-shear specimen dimensions

The quasi-static tensile-shear test samples were prepared according to ANSI/AWS/SAE/D8.9-97 standard [15]. Fig. 2 shows the sample dimensions of the tensile-shear test. Since the tensile-shear specimen is asymmetrical, two shims having same thickness were added at the grip sections of the specimen to ensure the alignment and to reduce the sheet bending and nugget rotation. The tensile-shear tests were performed at a cross head of 2 mm/min with an Instron universal testing machine. Peak load (measured as the peak point in the load-displacement curve) and failure energy (measured as the area under load-displacement curve up to peak point) were ex-

tracted from the load-displacement curve. Failure modes were determined by observing the weld fracture surfaces.

Samples for metallographic examination were prepared using standard metallography procedure. Optical microscopy was used to examine the macro and microstructures and to measure fusion zone (i.e. weld nugget) size.

Microhardness test, a technique that has proven to be useful in quantifying the microstructure-mechanical properties relationship, was used to determine the diagonal hardness profile using an indenter load of 100 g for a period of 20 s to obtain hardness. The hardness indentations were spaced 0.3 mm apart.

3. Results and discussion

3.1. Microstructure and hardness profile

Macro/microstructural attributes and hardness characteristic of the resistance spot welds are the most important factors affecting their failure behavior. Fig.3a shows the macrostructure of HSLA steel RSW. The joint region consists of three distinct zones:

(i) fusion zone (FZ) or weld nugget, which is melted during welding process and is resolidified showing a cast structure. Macrostructure of the weld nugget consists of columnar grains.

(ii) heat affected zone (HAZ) which is not melted but undergoes microstructural changes.

(iii) base metal (BM).

Fig. 3b shows a typical hardness profile of the resistance spot welded HSLA420 steel. The hardness of HSLA base metal hardness is about 180 HV which is corresponding to its microstructure (i.e. fine polygonal ferrite grain).

As can be seen in Fig. 3c, FZ exhibits almost columnar grains of martensite with some allotriomorphic ferrite with an average hardness of 360HV (Fig. 3b). Martensite formation in the FZ is attributed to the inherently high cooling rate of resistance spot welding process due to the presence of water cooled copper electrodes and their quenching effect as well as the short welding cycle.

Weld fusion zone microstructure of low carbon steel RSWs depends on chemical composition of the sheet and cooling rate. Gould et al. [16] proposed a simple analytical model predicting cooling rate during resistance spot welding. According to this model, cooling rate for 1.5 mm thickness is about 4000 Ks^{-1} . Presence of water cooled copper electrodes and their quenching effect as well as short welding cycle can explain high cooling rates of RSW process. For steels, the required critical cooling rate to achieve martensite in the microstructure can be estimated using the following equation [17]:

$$\log v = 7.42 - 3.13 C - 0.71 Mn - 0.37 Ni - 0.34 Cr - 0.45 Mo \quad (1)$$

where, v is the critical cooling rate in Kh^{-1} . For the investigated steel, the critical cooling rate is about 1265 Ks^{-1} . Since the cooling rate exceeds the calculated critical value; therefore, it is expected that the fusion zone microstructure consists of mainly martensite, as it is observed. The formation of martensite in the FZ explains the higher hardness of the FZ

compared to the BM hardness. It should be mentioned that the effect of welding current on FZ hardness is not significant. Due to the very high cooling rate of RSW process, the effect of welding parameters on the final FZ microstructure can be ignored [18-19].

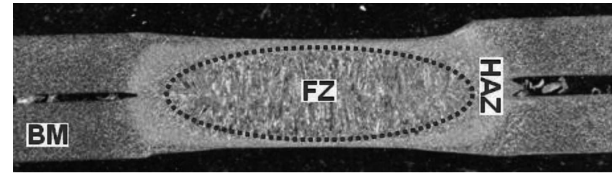

(a)

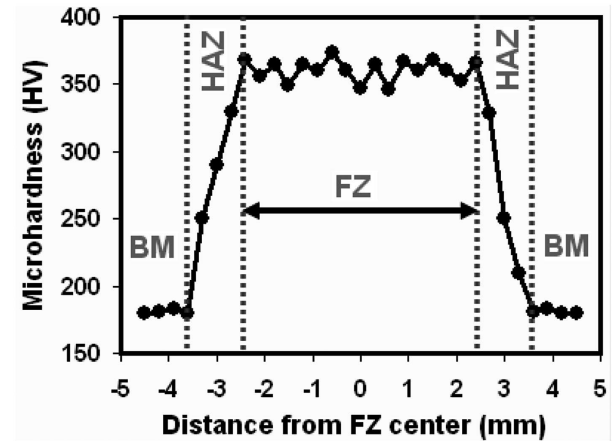

(b)

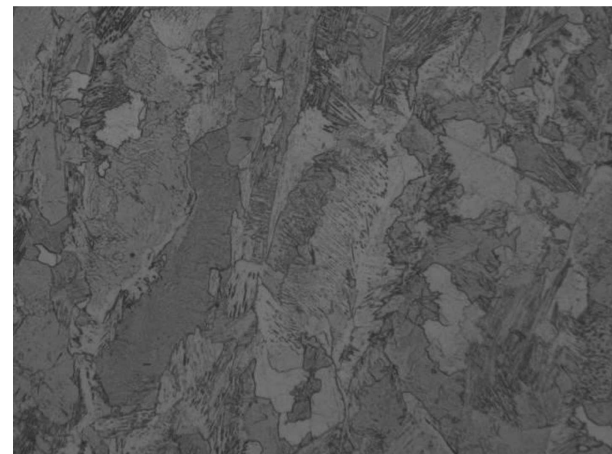

(c)

Fig. 3. A typical a) macrostructure b) hardness profile and c) the FZ microstructure of HSLA steel RSW

3.2. Critical FZ size

Two distinct failure modes were observed during the static tensile-shear test: interfacial fracture and nugget pullout. Fig. 5 shows typical fracture surfaces of welds in interfacial and pullout mode. As can be seen from Fig. 4, almost no plastic deformation is observed for interfacial failure mode, while pull out mode accompanied by considerable plastic deformation. Therefore, from the point of view of macro-fracture mechanism, the interfacial mode exhibits brittle mode and the pullout mode exhibit ductile mode.

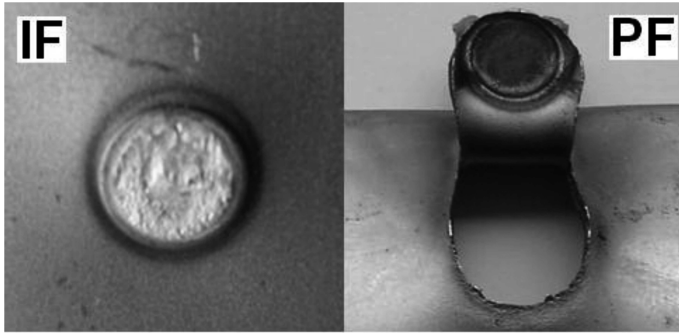

Fig. 4. Typical observed failure mode

Fig. 5 shows the effect of welding current on the FZ size and failure mode. As can be seen FZ size increases as the welding current increases due to increasing heat generation at the faying surfaces. Increasing welding current from 6 to 11.5 kA increases FZ size from 3 to 7.8 mm. Also, metallographic investigation showed that increasing welding current increases the relative weld penetration from 35% to 72% of sheet thickness. Experimental results showed that increasing welding current alters the failure mode from the interfacial one to the pullout one. Minimum welding current of 9.5 kA is required to ensure PF mode.

Failure of the spot welds can be considered as a competitive process, i.e. failure occurs in a mode which needs less force. During tensile-shear test, the shear stress at the sheet/sheet interface is the driving force for the IF mode, and the tensile stress at the nugget circumference is the driving force for the PF mode [20-21]. Each driving force has a critical value and the failure occurs in a mode which its driving force reaches its critical value, sooner. The FZ size is the governing parameter determining stress distribution. For small weld nuggets, the shear stress reaches its critical value before the tensile stress causes necking; thus, failure tends to occur under IF mode. Therefore, there is a critical weld FZ size beyond which, the PF mode is expected. As can be seen in Fig. 5, minimum FZ size of 6.2 mm is required to ensure PF mode.

According to historical criterion of $4t^{0.5}$, the minimum FZ size required to ensure that the pullout failure mode happens, for 1.5 mm thick sheet, is 4.89 mm. However, as can be seen from Fig. 5, the critical FZ size is well above the conventional FZ size recommendation.

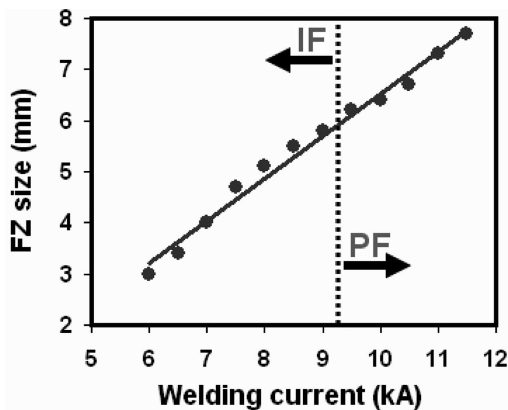

Fig. 5. Effect of welding current on the FZ size

3.3. Failure mode analysis

In this section, a simple analytical model is used to predict joint failure mode during the tensile-shear testing of HSLA steel resistance spot welds.

Considering nugget as a cylinder with (d) diameter and ($2t$) height, failure load at the interfacial failure mode (P_{IF}) could be expressed as equation (2) assuming uniform distribution of shear stress in the weld interface:

$$P_{IF} = \left(\frac{\pi d^2}{4}\right)\tau_{FZ} \quad (2)$$

Where: τ_{FZ} is the shear ultimate strength of the FZ.

In the pullout failure mode, it is assumed that failure occurs when maximum radial stress at the circumference of one half of the cylindrical nugget reaches the ultimate strength of the failure location. Therefore, equation (3) is suggested for the pullout failure of spot weld in the tensile-shear test.

$$P_{PF} = \pi dt(\sigma_{UTS})_{FL} \quad (3)$$

where $(\sigma_{UTS})_{FL}$ is the ultimate tensile strength of pullout failure location.

Failure is a competitive process, i.e. spot weld failure occurs in a mode which needs less force. A critical fusion zone size (d_{Cr}) can be defined which determines which one of the failure modes happens. Spot welds with $d < d_{Cr}$ tend to fail via interfacial failure and welds with $d > d_{Cr}$ tend to fail via nugget pullout failure mode.

Therefore, to obtain critical nugget diameter, d_{Cr} , equations (2) and (3) are intersected resulting in equation (4):

$$d_{Cr} = 4t \frac{(\sigma_{UTS})_{FL}}{\tau_{FZ}} \quad (4)$$

Direct measurement of the mechanical properties of different regions of spot weld is difficult. It is well known that there is a direct relationship between materials tensile strength and their hardness. Also, shear strength of materials can be related linearly to their tensile strength by a constant coefficient, f . According to Tresca's criterion f is 0.5. On that account, equation 4 can be rewritten as follows

$$d_{Cr} = 4t \frac{H_{FL}}{f \times H_{FZ}} \quad (5)$$

According to Eq. 5, the critical fusion zone size depends on the FZ and pullout failure location hardness, in addition to sheet thickness. For a constant sheet thickness, decreasing the ratio of fusion zone hardness to failure location hardness raises its tendency to fail under the interfacial failure mode (i.e. larger d_{Cr}).

Fig. 6 shows the cross section of a sample failed through the pullout failure mode during the tensile-shear test. The characteristic mechanisms of the PF mode in the tensile-shear testing include rotation of the weld nugget, and stretching, thinning, and necking in the nugget circumference. Indeed, even though the loading condition is nominally shear, the failure mode is predominantly tensile through rotation and preferential necking in the soft region of the nugget circumference [8-20-21]. As can be seen, the location of the failure initiation (i.e. the location of necking) is at BM. This can be attributed to the low hardness of the base metal rather than HAZ and

fusion zone which provide a preferential location for necking during the tensile-shear test.

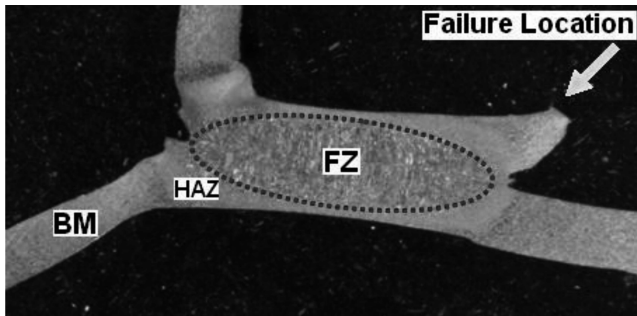

Fig. 6. Cross sections of fracture surfaces of spot welds in tensile-shear test: One leg of the lower sheet and one leg of the upper are subjected to tensile stress. Failure is initiated from one of these legs

In the case of HSLA420 steel RSW, average FZ hardness is about 360 HV and hardness of the failure location (i.e. BM) is about 180 HV. Therefore, the hardness ratio of FZ to failure location is about 2. It should be mentioned that the value of FZ hardness and hence the hardness ratio are assumed constant for two main reasons. One, according to Fig.3b, no fluctuation is observed in FZ hardness profile and two, is that the effect of welding parameters on the FZ hardness is negligible. By substituting these values in equation 5, critical fusion zone size is calculated to be 6 mm. Fig. 5 shows that this value separates the interfacial and nugget pullout failure modes.

3.4. Mechanical properties

The effect of the FZ size on the peak load and energy absorption of the spot welds is shown in Fig. 7. As can be seen, there is a direct relations between the FZ size and the peak load (energy absorption). It can be concluded that the weld FZ size is the main controlling factor of the RSW mechanical properties in terms of the peak load and energy absorption. This can be attributed to i) transition of the failure mode from interfacial to pullout by increasing the FZ size and ii) increasing the overall bond area in both failure modes by increasing the FZ size.

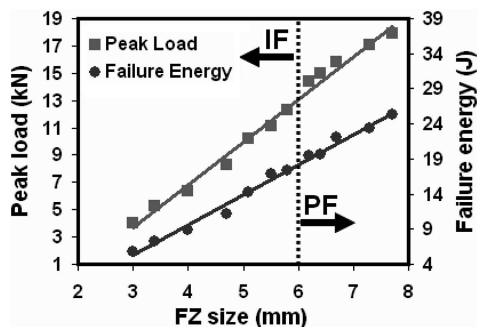

Fig. 7. Effect of FZ size on the peak load and failure energy

4. Conclusions

Mechanical properties and failure mode of resistance spot welded HSLA420 steel are studied. The following can be drawn from the result of this study:

1. Critical weld nugget diameter recommended of $4t^{0.5}$ is not sufficient to guarantee the pullout failure mode for HSLA steel resistance spot welds.
2. The following relation is proposed to predict minimum FZ size (d_{cr}) required to ensure pullout failure mode during the tensile-shear test:

$$d_{Cr} = 4t \frac{H_{FL}}{f \times H_{FZ}}$$

Where t is sheet thickness, f is ratio of shear strength to tensile strength H_{FZ} and H_{FL} are hardness of fusion zone and failure location respectively.

3. According to this model, low fusion zone hardness to failure location hardness ratio increases the tendency of spot weld failure to occur in the interfacial failure mode during the tensile-shear test. Metallurgical characteristics of welds should be considered to predict and analyze the spot weld failure mode more precisely.

4. The proposed analytical model successfully predicts the critical weld fusion zone size for HSLA spot welds.

5. Fusion zone size proved to be the most important controlling factor of the spot weld peak load and energy absorption primarily due to the increasing of the overall bond area caused by increasing the FZ size and also as a consequence of the transition in the failure mode from interfacial to pullout.

REFERENCES

- [1] M.S. Weglowski, S. Stano, G. Michta, W. Osuch, Structural Characterization of Nd:YAG Laser Welded Joint of Dual Phase Steel, Archives of Metallurgy and Materials **55**, 211-220 (2010).
- [2] X. Sun, E.V. Stephens, M.A. Khaleel, Effects of fusion zone size and failure mode on peak load and energy absorption of advanced high strength steel spot welds under lap shear loading conditions, Eng. Fail. Anal. **15**, 356-367 (2008).
- [3] Z. Gronostajski, A. Niechajowicz, S. Polak, Prospects for the Use of New-Generation Steels of the AHSS Type for Collision Energy Absorbing Components, Archives of Metallurgy and Materials **55**, 221-230 (2010).
- [4] M. Pouranvari, A. Abedi, P. Marashi, M. Goodarzi, Effect of expulsion on peak load and energy absorption of low carbon resistance spot welds, Sci. Technol. Weld. Joining **13**, 39-43 (2008).
- [5] X. Sun, E.V. Stephens, M.A. Khaleel, Effects of Fusion Zone Size and Failure Mode on Peak Load and Energy Absorption of Advanced High Strength Steel Spot Welds Weld. J. **86**, 18-25 (2007).
- [6] H. Zhang, M. Zhou, S.J. Hu, Impact Strength Measurement of Spot Welds, Proceedings of the institute of Mechanical Engineering, Part B: Journal of Engineering Manufacture **215**, 403-414 (2001).
- [7] M. Pouranvari, S.P.H. Marashi, Key factors influencing mechanical performance of dual phase steel resistance spot welds, Sci Technol Weld Join **15**, 149-155 (2010).
- [8] S.M. Zuniaga, Predicting overload pull-out failures in resistance spot welded, Ph.D. thesis, Stanford University, 1994.

- [9] V.H. Baltazar Hernandez, M.L. Kuntz, M.I. Khan, Y. Zhou, Influence of weld size and microstructure of dissimilar AHSS resistance spot welds, *Science and technology of welding and joining* **13**, 769-776 (2008).
- [10] M. Marya, X.Q. Gayden, Development of Requirements for resistance Spot Welding Dual-Phase (DP600) Steels Part 2: Statistical Analyses and Process Maps, *Weld J.* **84**, 197-204 (2005).
- [11] R.M. Rivett, Assessment of resistance spot weld in low carbon and high strength steel sheet-Part I static properties, Research report, The Welding Institute, 1982.
- [12] J.M. Sawhill, J.C. Baker, Spot weldability of high-strength sheet steels, *Weld. J.* **59**, 19-30 (1980).
- [13] B. Pollard, Spot welding characteristics of HSLA steel for automotive applications *Weld. J.* **53**, 343-350 (1974).
- [14] J. VandenBosche, Ultimate strength and failure mode of spot welds in high strength steels, SAE paper 770214, 1977.
- [15] Recommended practices for test methods and evaluation the resistance spot welding behavior of automotive sheet steels, ANSI/AWS/SAE D879-97, 1997.
- [16] J.E. Gould, S.P. Khurana, T. Li, Predictions of microstructures when welding automotive advanced high-strength steels, *Weld J.* **86**, 111-116 (2006).
- [17] K.E. Easterling, Modelling the weld thermal cycle and transformation behavior in the heat-affected zone. *Mathematical Modelling of Weld Phenomena*, 1993, Eds. Cerjak H and Easterling K. E. The Institute of Materials.
- [18] M. Pouranvari, S.P.H. Marashi, D.S. Safanama, Failure mode transition in AHSS resistance spot welds. Part II: Experimental investigation and model validation, *Materials Science and Engineering: A*, **528**, 8344-8352 (2011).
- [19] P. Burgmann, K. Clymer, S. Cobb, M. Miller, A. O'Loughlin, K.O. Findley, S. Liu, Weldability, Processing, Microstructure and Mechanical Behavior Relationships in Advanced High-Strength Steel, *Iron and Steel Technology* **7**, 76-85 (2010).
- [20] S. Zuniga, S.D. Sheppard, in 'Fatigue and fracture mechanics', Vol. 27, ASTM STP 1296, (ed. R. S. Piascik et al.), 469-489; 1997, Philadelphia, USA, ASTM. 09356729304.
- [21] P.C. Lin, S.H. Lin, J. Pan, Modeling of failure near spot welds in lap-shear specimens based on a plane stress rigid inclusion analysis, *Eng. Fract. Mech.* **73**, 2229-2249 (2006).