

CHIPFORMERS RELIABILITY IN INCONEL 625 LONGITUDINAL TURNING

Bogdan Słodki

Cracow University of Technology, Production Engineering Institute, Poland

Corresponding author:

Bogdan Słodki

Cracow University of Technology

Production Engineering Institute

Aleja Jana Pawła II 37, 31-864 Cracow, Poland

phone: +48 12 374 32 50

e-mail: slodki@mech.pk.edu.pl

Received: 20 May 2013

Accepted: 6 June 2013

ABSTRACT

The paper deals with longitudinal turning of Inconel 625 as a representative of difficult – to – cut materials. Two chipformers were tested on especially prepared research stand in the range of tool manufactures recommendations concerning depth of cut and feed. Chip form creation process was observed by means of high speed camera recording system. Then, the chips were evaluated and classified into three groups. The results are presented in the form of diagrams and tables. They show poor effectiveness of chipformers acting in small values of feed. A few examples of chip breaking sequences are presented. An algorithm leading to correct cutting data selection has been proposed. The algorithm uses a simulation procedure to verify chip groove filling in off line procedure.

KEYWORDS

turning, chips, superalloy, chipformers, vision system.

Introduction

Problems connected with chips formation have particular significance when difficult-to-cut materials are the subject of turning or milling operations [1, 2]. One of these group is called HRSA (*Heat Resistant Super Alloys*). These materials (based on nickel, cobalt or iron) are resistant to temperature and corrosion (especially pitting and crevice corrosion). They are widely used in chemical, aircraft and shipbuilding industries. Inconel 625, a tested superalloy based on nickel, belongs to this group [3].

For all these alloys high temperature characteristics translate directly to machining challenges. Usually during machining there is combination of high cutting force and high temperature in cutting zone. This often leads to edge breakdown of the tool (insert) through chipping or deformation. In addition, workpiece surface hardens very quickly. A hardened surface can result in depth-of-cut-line notching of the tool and may also compromise the fatigue strength

and geometric accuracy of the part. The machinability of HRSA strongly depends on the prior treatment of the material. That is described in details in various guides published by tool manufactures, SANDVIK-Coromant for example [4]. For all reasons described above, high temperature alloys demand special machining techniques.

Modern cutting tools are composed of an insert and a toolholder. Carbide inserts intended for machining these alloys have chipformers, of various geometries, shaped on a rake face. The task of a chipformer is to direct a chip to hit the flank surface of a tool or the workpiece rough surface. Then the breaking process can take place. Incorrect chips (e.g. long spiral or continuous) leaving cutting zone in out-of-control manner can damage machined surface and disqualify the workpiece.

In the paper the presented results of machining tests revealed various forms of chips achieved in longitudinal turning of Inconel 625 as well as they also enabled to verify the chipformers effectiveness under local operating features.

Research stand and tested tools

To record and observe particular phases of chip creation and breakage a visual system based on high speed camera technology (together with appropriate software) has been used.

The tests were performed without coolant to avoid problems with vision observation and additionally to protect environmental pollution which is in agreement with modern trends of machining [5].

The stand (Fig. 1) consisted of:

1. High speed camera Phantom V5.2
2. Lens Nikkor AF Micro 200 mm f/4D IF-ED
3. Various lighting systems (dispersed and spot lighting)
4. Precision lathe (Masterturn 400) for testing tools and work materials

Such lay-out equipped with the proper computer programs (Cine Viewer in this case) enables to ob-

serve the way of chip breakage, calculate the time of particular chip creation, test the correctness of chip groove filling simulation or to verify the correctness of force measurement system indications concerning number of chips achieved in time unit and the time of their creation (Fig. 2).

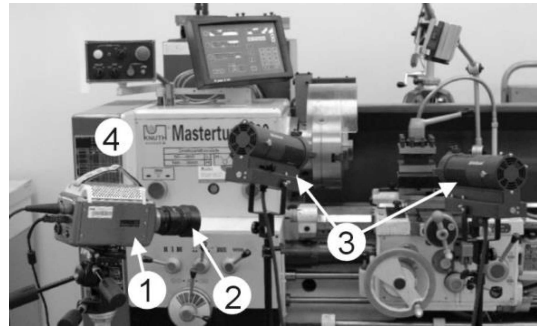

Fig. 1. Research stand equipped with vision system based on high speed camera.

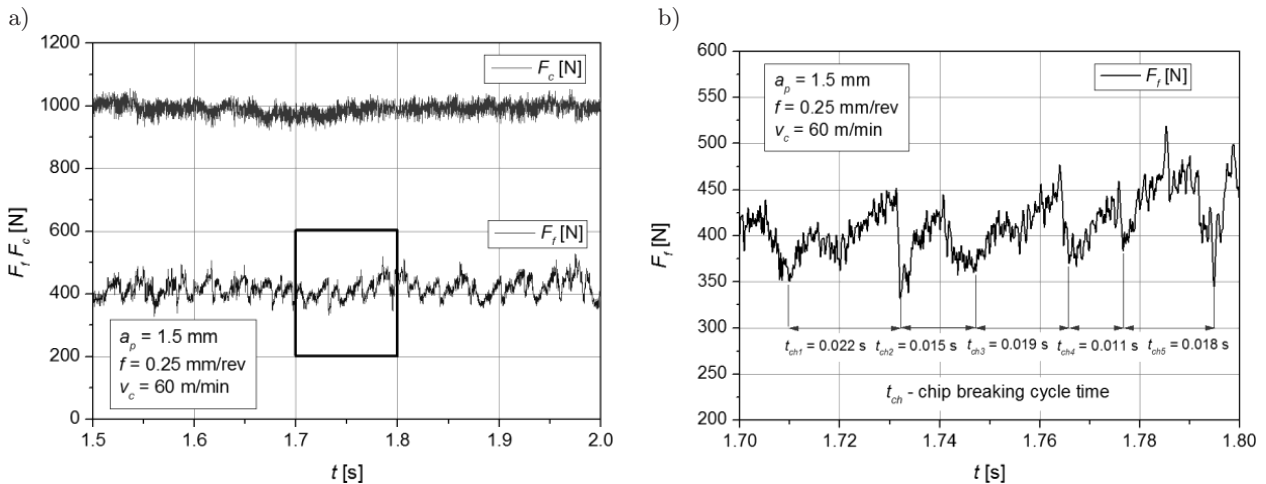

Fig. 2. Components F_c and F_f of cutting force a), chip formation time calculated on the base of F_f cutting force component b).

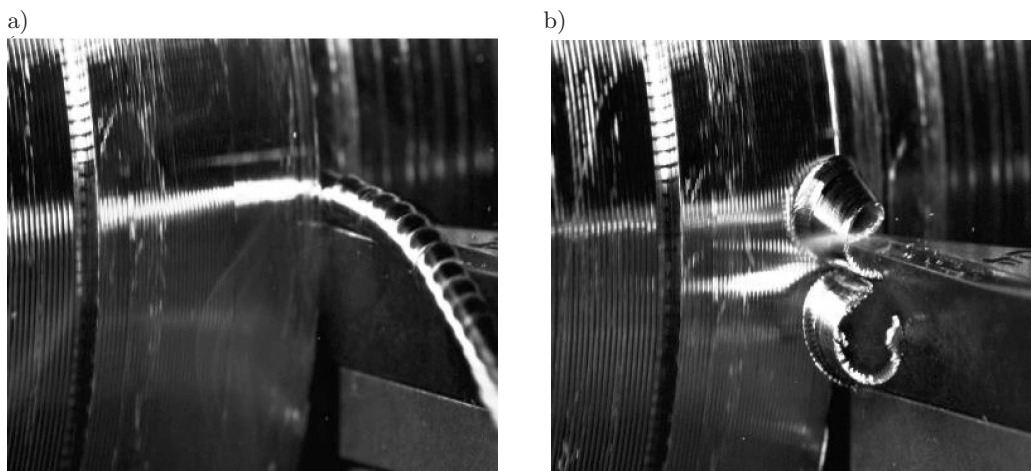

Fig. 3. Example of unacceptable chip form, Inconel 625, $v_c = 65$ m/min, $a_p = 2.0$ mm, $f = 0.077$ mm/rev a), and correct form for the same cutting speed and depth of cut but for the feed $f = 0.153$ /rev b).

For example, for cutting data shown in Fig. 2 the number of identified chips per second according to the analysis of F_f component of cutting force was 55 while the recording showed 49 chips at the same time. This means that the graph is not unequivocal. Chip breaking time depends on a chip length and shape which can change continuously, that is why chip breaking time differs for every chip, Fig. 2b. Additionally, while curving, a chip may hit side surface of a workpiece (Fig. 3b) what introduce measurement disturbance.

A typical utilization of vision system is shown in Fig. 3, where two examples of chip form are presented. On the left side there is an example of spiral long chip i.e. unacceptable chip form, while on the right there is an example of correct, desired chip form, loose arc.

Below there are presented two tools used in cutting test. Figure 4a, shows the measured geometry

of the chipformer 23 formed on the rake face of WNMG 080404 insert and Fig. 4b, a model of assembled tool.

Figure 5a, shows the measured geometry of SM chipformer, (insert VCMT 160404), and Fig. 5b, a model of assembled tool.

Specification concerning insert type, grade and toolholders is presented in Table 1 as well as application recommended areas suggested by tool manufacturers concerning both tools. All test were performed approximately in these operating ranges although tests for the insert WNMG 080404 were limited to the depth of cut $a_p = 2.0$ mm. The aim of cutting tests was intended to estimate their efficiency in the local operating environment (tool-machine tool-workpiece material) [7]. This enabled to define the actual field of their application leading to achieving correct or acceptable chip forms.

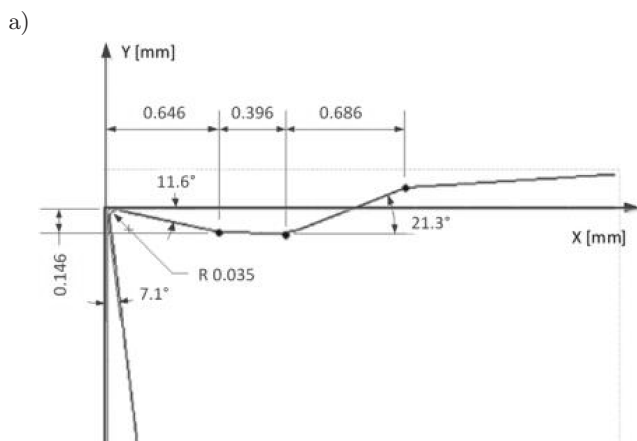

Fig. 4. Chipformer 23 measured geometry a) and assembled tool [6] b).

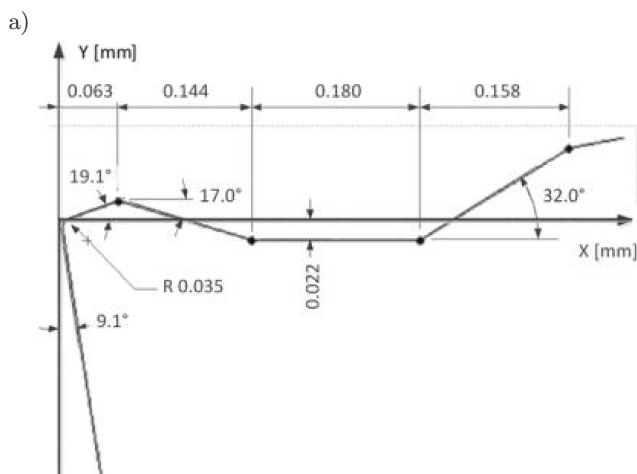

Fig. 5. Chipformer SM measured geometry a) and assembled tool [6] b).

Table 1
 Specification of tools used in tests [8, 9].

| Insert manufacturer | SANDVIK Coromant | ISCAR |
|---|--|--|
| Type | WNMG 080404-23 | VCMT 160404-SM |
| Grade | GC 1105 | IC 908 |
| Toolholder | PWLNK 2020K 08 | SVJCR 2020K-16 |
| Manufacturer application recommended area | $a_p = 0.5-4.0$ mm $f = 0.1-0.3$ mm/rev | $a_p = 0.5-2.5$ mm $f = 0.05-0.25$ mm/rev |

Cutting tests and their results

After having performed cutting tests (cutting speed for the chipformer SM, $v_c = 65$ m/min, for the chipformer 23, $v_c = 50$ and $v_c = 75$ m/min), chips were collected and classified into three groups. The classification was based on the author and industry experience. They were marked in the following way:

“X” – unacceptable chip form, “O” – acceptable chip form, “+” – correct chip form. The correct chips are short (arc, short spiral type) and they are removed from working area in one direction. In theory, for the whole recommended area, in the range of speed acceptable for a given insert, such phenomena should take place. In practice, only a part of produced chips belongs to this range. Besides, there are so called acceptable chips which present some features a bit different from “a correct chip.” They may be short, spiral, segmental but of different shapes, they often leave cutting zone in unpredictable direction. In practice, the majority of chips belong to acceptable chips. The unsuitable, undesired chips have usually long, curly continuous form.

Then, after classification [6], the area including correct and accepted chips was compared with recommended application areas proposed by tool manufacturers (Figs. 7, 9, 11).

Looking at the Figs. 6, 8 and 10 it is noticeable that tested chipformers do not perform efficiently their task for lower values of feed. For greater values of feed both chipformers work correctly probably due to the fact that there is better filling of chip groove.

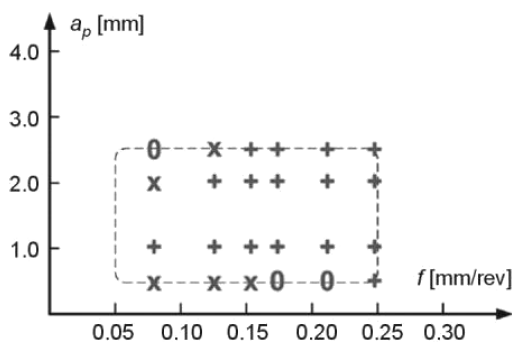
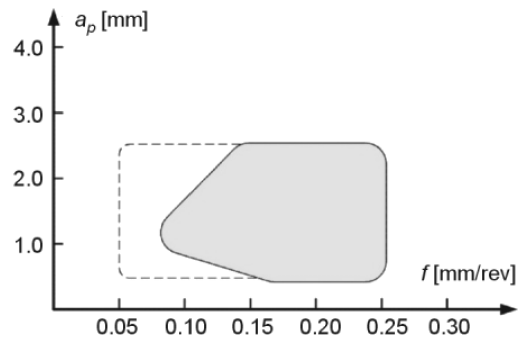
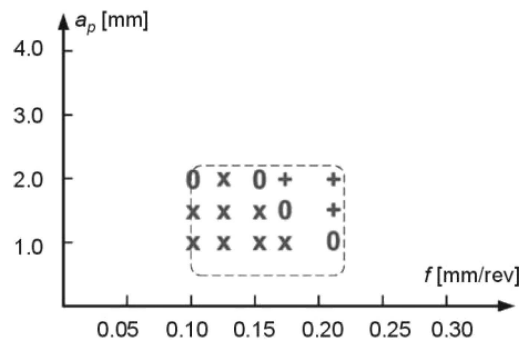
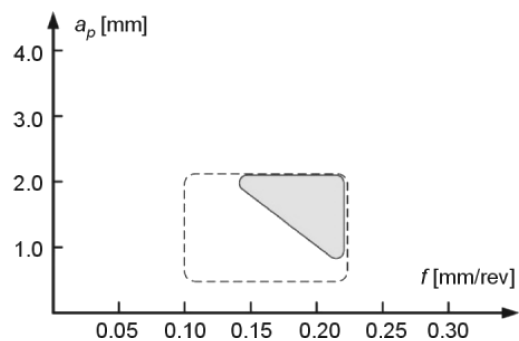
 Fig. 6. Correct, acceptable and unacceptable chips, $v_c = 65$ m/min, chipformer SM.

 Fig. 7. Usable chipformer SM area in tested operating features, $v_c = 65$ m/min

 Fig. 8. Correct, acceptable and unacceptable chips, $v_c = 75$ m/min, chipformer 23

 Fig. 9. Usable chipformer 23 area in tested operating features, $v_c = 75$ m/min.

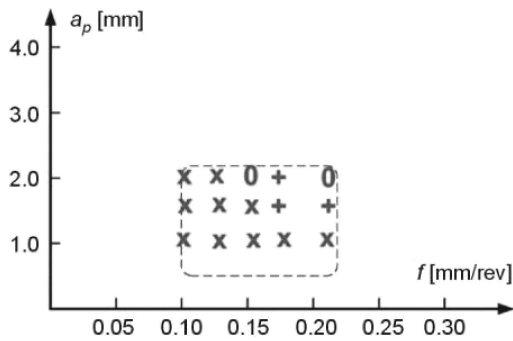

Fig. 10. Correct, acceptable and unacceptable chips, $v_c = 50$ m/min, chipformer 23.

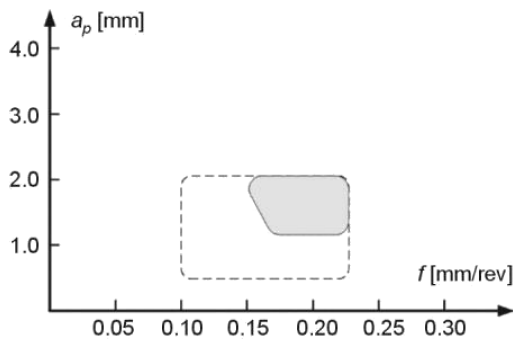

Fig. 11. Usable chipformer 23 area in tested operating features, $v_c = 50$ m/min.

Figures 12, 13 and 14 shows the efficiency of tested chipformers in tested machining environment. It is surprising the low efficiency of 23 chipformer for cutting speed $v_c = 50$ m/min (33%) as well as for cutting speed $v_c = 75$ m/min (47%). On the other hand, it must be remembered that under different local operating features the results may more come up to tool manufacturers' expectations.

The interesting phenomenon is shown in Table 2 and 3. An area of unacceptable chips is laid between acceptable or correct chips. It is visible in Table 2 and 3 ($f = 0.125$ mm/rev, $a_p = 2.5$ mm for SM chipformer and $f = 0.125$ mm/rev, $a_p =$

2.0 mm for 23 chipformer) This means that when the feed is increased it is not obvious that the created chips will have correct or acceptable forms what takes place usually. It is difficult to explain this but the most probable explanation is the catastrophe theory. In this case a small change in machined material morphology (discontinuity of material structure) can have significant impact on the chip form.

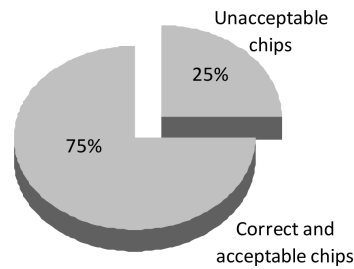

Fig. 12. Percentage of correct and acceptable chips versus unacceptable chips for SM chipformer for $v_c = 65$ m/min.

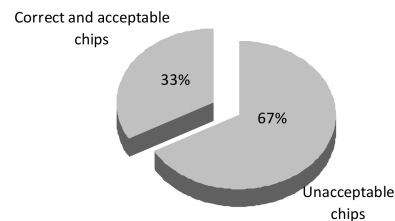

Fig. 13. Percentage of correct and acceptable chips versus unacceptable chips for 23 chipformer, $v_c = 50$ m/min.

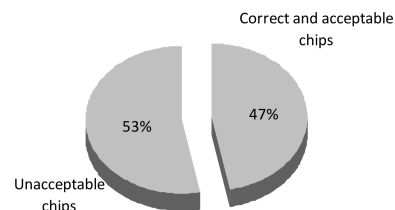







Fig. 14. Percentage of correct and acceptable chips versus unacceptable chips for 23 chipformer, $v_c = 75$ m/min.

Table 2
Selected chip forms for chipformer SM, $v_c = 65$ m/min.

| a_p [mm] | f [mm/rev] | | | | | |
|------------|--------------|-------|-------|-------|-------|-------|
| | 0.077 | 0.125 | 0.153 | 0.173 | 0.211 | 0.249 |
| 2.5 | | | | | | |

Table 3
 Selected chip forms for chipformer 23, $v_c = 75$ m/min.

| a_p [mm] | f [mm/rev] | | | | |
|------------|---|---|---|--|---|
| | 0.105 | 0.125 | 0.153 | 0.173 | 0.211 |
| 2.0 |  |  |  |  |  |

It follows that in the area of proper solutions concerning acceptable cutting data there are indefinite chip forming areas. Probably, in these areas there is instability of material deformation in the chip formation process. As a result it is possible to achieve adjacent, random different chip varieties (e.g. segmental chip followed by continuous).

Examples of chipbreaking sequences recorded with vision system

The following presents a few examples of chip forming in turning operation of Inconel 625. Figure 15 presents selected frames presenting the whole

sequence of chip breakage. In this case, the breaking process is due to the fact that a chip curls and hits the flank surface of the insert.

Two ways of chipbreaking in one cut can also be observed. Figure 16 shows an example of chipbreaking cycle under the following cutting conditions: $v_c = 65$ m/min, $a_p = 2.5$ mm, $f = 0.153$ mm/rev. Chips were formed by hitting workpiece rough surface or by hitting flank surface of a tool. Sometimes, although the beginning of breaking cycle seemed to end with hitting workpiece rough surface it actually ended with hitting flank surface of a tool because a chip skipped from rough surface. It was the random process.

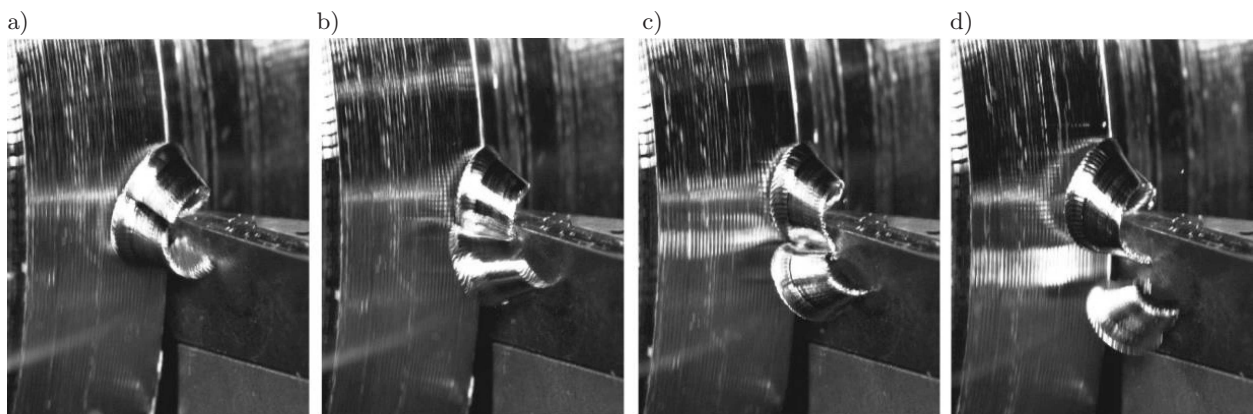

Fig. 15. Correct chip breaking sequence in Inconel 625 turning, insert VCMT 160404-SM, $a_p = 2.0$ mm, $f = 0.153$, $v_c = 65$ m/min, 1000 fps.

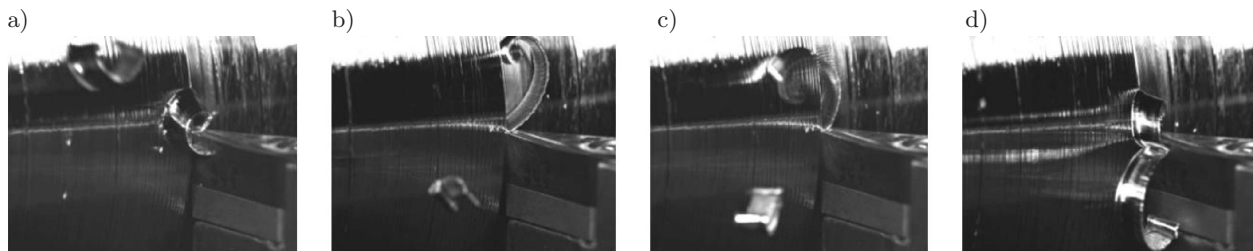

Fig. 16. Two kinds of chip breaking way in one cut, Inconel 625, $v_c = 65$ m/min, $a_p = 2.5$ mm, $f = 0.153$ mm/rev, chipformer – SM, recording 1000 fps, a) end of breaking cycle, b) chip hits the raw surface of the workpiece and bends back, c) suddenly chip slips to the left, d) breaking process ends by hitting flank surface of the insert [10].

Cutting data selection, suggested solution

Figure 17 presents a simplified algorithm suggesting the way of cutting data selection. The tool (an insert to be precise) and cutting data are preliminary set on the basis of workpiece requirements and tool manufacturer recommendations. An experience of production engineer plays in this moment important role. Next, when the cutting tests take place it is necessary to monitor chips form. If the monitored chip form (e.g. by a high speed camera) is acceptable or correct, the turning process can be stopped

only when any limitation in set of monitoring modules is exceeded. Otherwise, the process can go on. If the chip form is incorrect, an adjustment of cutting data (feed value first of all) have to be checked. The feed value is related to roughness, insert grade, the main cutting force and useful chipformer area. If it is possible, feed value should be increased. To check the influence of feed correction, the simulation procedure has to be applied. In the simulation module it is possible to investigate the chip groove filling (Fig. 18) as well as the levels of cutting forces, roughness and distribution of temperature in the cutting zone. This knowledge is indispensable to make any decision concerning the cutting data correction.

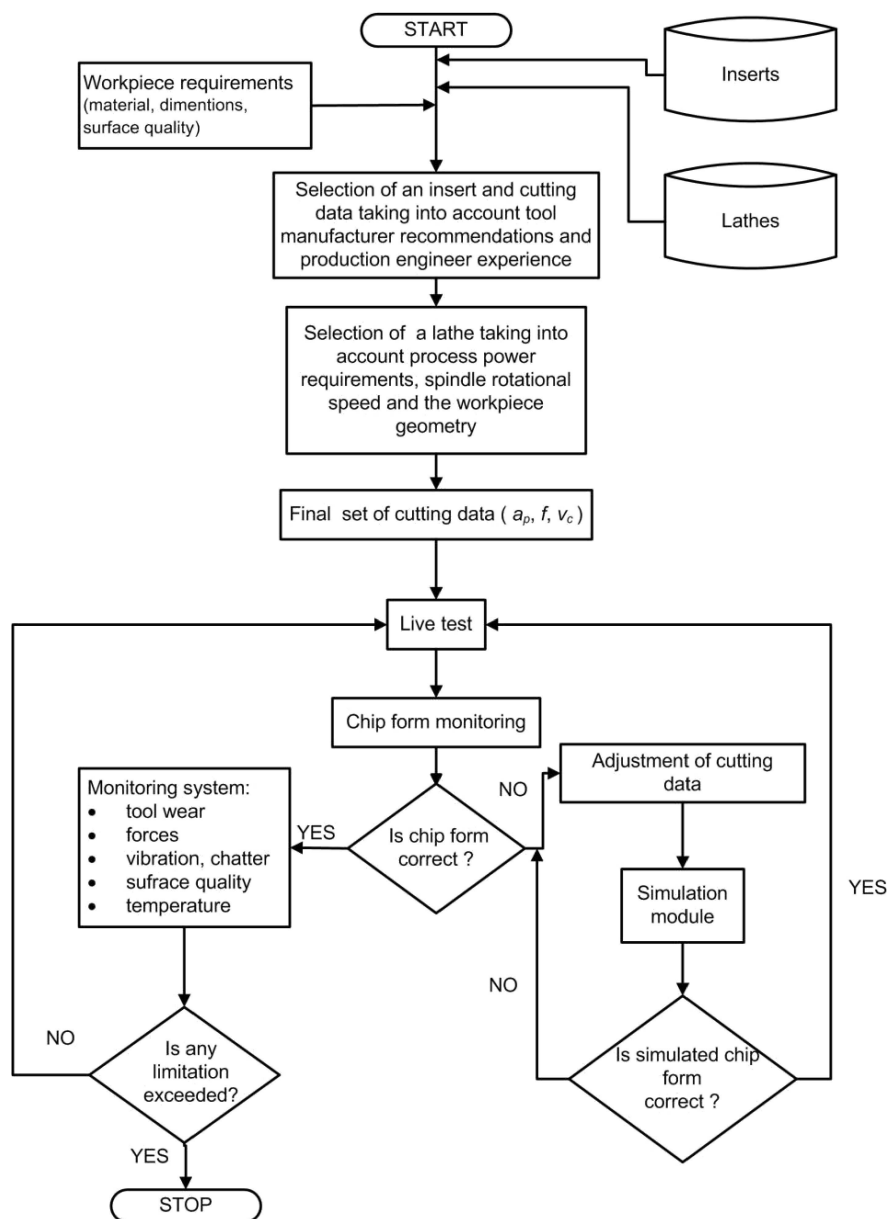

Fig. 17. A simplified algorithm of cutting data selection in turning.

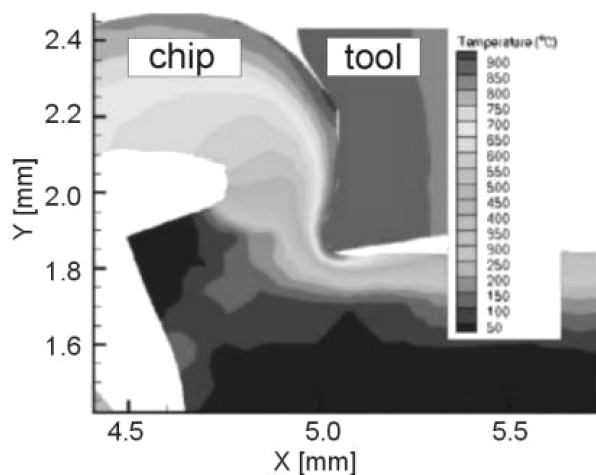

Fig. 18. The example of cutting zone model created by means of FEM (Finite Element Method) for turning Inconel 625 alloy with SM chipformer according to [11]. Cutting data: $f = 0.153$ mm/rev, $v_c = 65$ m/min, $a_p = 1.5$ mm. Distribution of temperature and groove filling

Although simulation has its drawbacks (the validation of input data) it is the only possible off line way to preliminary check the correctness of cutting data selection.

Concluding remarks

In the paper two chipformers were tested in longitudinal turning of Inconel 625. For observation of chip forms creation a vision system was used. Tools used in tests were produced by two manufacturers. In each case the chipformer application area has been directly and precisely described and recommended in manufacturers catalogues. It can be stated that in some cases these recommendations used in local machining environment proved to be correct but on the other hand even the maximum result of achieving 75% correct and acceptable chips can not be satisfactory for industry implementations.

It means that the theory of chip shape creating and flow direction is still not applicable for every case [12, 13]. Hence, it is strongly recommended to perform test machining using preliminary selected cutting data set, monitor chip form and then, if necessary, adjust cutting data.

This is also important because it has been checked that there is no influence of typical tool wear on the chip form [14].

The example in Fig. 19 shows minimal change of chip form for developed flank wear of a carbide insert. It means that once selected and successfully

tested set of cutting data is supposed to give correct chip form for the whole tool life.

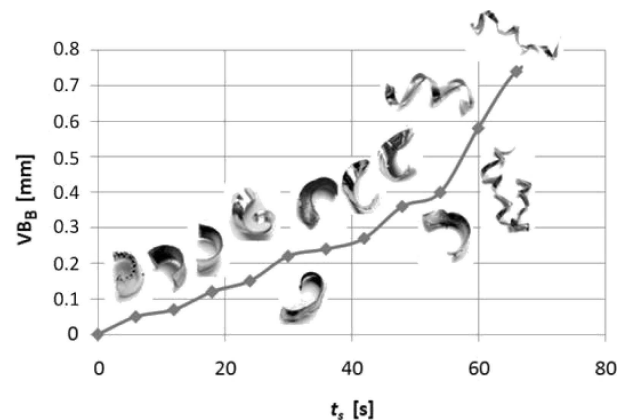

Fig. 19. The example of chip form changes and its dependence from VB wear criterion in turning Inconel 625: $f = 0.153$ mm/rev, $v_c = 65$ m/min, $a_p = 1.0$ mm, chipformer SM [14].

References

- [1] Ezugwu E.O., Wang Z.M., Machado A.R., *The machinability of nickel based alloys: a review*, Journal of Materials Processing Technology, 86 (1–3), 1–16, 1998.
- [2] Zębala W., *Milling optimization of difficult to machine alloys*, Management and Production Engineering Review, 1, 1, 59–70, 2010.
- [3] INCONEL 625, <http://www.matweb.com>.
- [4] HRSA – reference book [in Polish: *Superstopy żaroodporne – poradnik*, Sandvik Polska Sp. z o.o., 2007.
- [5] Kundrak J., Varga G., *Possibility of reducing environmental load in hard machining*, Key Engineering Materials, 496, 205–210, 2012.
- [6] Słodki B., *Physical and technological aspects concerning chip curl and breaking in nickel based superalloys machining* [in Polish: *Fizyczne i technologiczne aspekty związania i łamania wióra w obróbce superstopów na bazie niklu*, Seria Mechanika, 408, Wydawnictwo Politechniki Krakowskiej, 2012.
- [7] Przybylski L., Słodki B., *The influence of Local Operating Features on Cutting Parameters in Turning*, The International Journal of Advanced Manufacturing Technology, 13, 4, 233–236, 1997.
- [8] Sandvik-Coromant Turning tools catalogue, 2010.
- [9] ISCAR, Turning tools catalogue, 2008.
- [10] Słodki B., *Selected sequences of chip breaking process in turning nickel based superalloys*, Ad-

- vances in Manufacturing Science and Technology, 35, 2, 29–36, 2011.
- [11] Zębała W., *Modeling difficult-to-cut materials turning* [in Polish: *Modelowanie procesu toczenia materiałów trudnoskrawalnych*], Czasopismo Techniczne, Wydawnictwo Politechniki Krakowskiej, 2, 135–148, 2011.
- [12] Jawahir I.S., van Luttervelt C.A., *Recent Developments in Chip Control Research and Applications*, CIRP Annals, 42/2, 695–685, 1993.
- [13] Pekelharing A.J., *Why and how does chip curl and break*, CIRP Annals, 12 (1), 144–147, 1964.
- [14] Słodki B., Struzikiewicz G., *Chip form changes in carbide insert wear process in Inconel 625 longitudinal turning* [in Polish: *Zmiana postaci wióra w procesie zużycia ostrza z węglików spiekanych w toczeniu wzdłużnym stopu Inconel 625*], Obróbka skrawaniem, nauka a przemysł pod redakcją Wita Grzesika, Wydawnictwo Sutoris, pp. 158–167, Opole 2011.