

S.M. SHIN*, D.J. SHIN*, G.J. JUNG**, Y.H. KIM***, J.P. WANG***,†

RECOVERY OF ELECTRODIC POWDER FROM SPENT NICKEL-METAL HYDRIDE BATTERIES (NiMH)**ODZYSKIWANIE PROSZKU ELEKTRODOWEGO ZE ZUŻYTYCH AKUMULATORÓW NIKŁOWO-WODORKOWYCH (NiMH)**

This study was focused on recycling process newly proposed to recover electrodic powder enriched in nickel (Ni) and rare earth elements (La and Ce) from spent nickel-metal hydride batteries (NiMH). In addition, this new process was designed to prevent explosion of batteries during thermal treatment under inert atmosphere. Spent nickel metal hydride batteries were heated over range of 300°C to 600°C for 2 hours and each component was completely separated inside reactor after experiment. Electrodic powder was successfully recovered from bulk components containing several pieces of metals through sieving operation. The electrodic powder obtained was examined by X-ray diffraction (XRD) and energy dispersive X-ray spectroscopy (EDX) and image of the powder was taken by scanning electron microscopy (SEM). It was finally found that nickel and rare earth elements were mainly recovered to about 45 wt.% and 12 wt.% in electrodic powder, respectively.

Keywords: Nickel-metal hydride (NiMH), electrodic powder, nickel, rare earth elements, thermal treatment

1. Introduction

Nickel-metal hydride (NiMH) batteries are rapidly conquering an important share of the rechargeable battery market [1]. Rechargeable, high-powered nickel-metal hydride batteries are widely used as power sources for cell phones, digital cameras, hybrid cars and so on. On the other hand, a large quantity of Ni-MH battery waste discharged from Ni-MH battery production factories and spent Ni-MH batteries has been disposed of as waste even though they contain valuable transition and rare-earth elements [2]. Their electrodes consist of foamed-nickel or copper plating strip as substrate and nickel hydroxide and AB₅-type hydrogen-storage alloy as active electrode material. Therefore, Ni-MH batteries contain valuable metals in which the average content of Ni, Co and light rare earths is about 30%, 4%, and 10%, respectively [3]. In addition, recycling will be significant due to the likelihood that the environmental regulations for nickel may become more stringent.

Many hydrometallurgical processes have been developed to recover metal values from spent Ni-MH batteries in recent years [4-12]. Tenorio and Espinosa used ore-dressing methods to recover the nickel based alloy from Ni-MH batteries [13]. Wang et al. regenerated the hydrogen-storage alloy from Ni-MH batteries, whose structure and electrochemical properties could be restored [14]. Zhang et al. reported a hydrometallurgical process for the separation and recovery of metal values such as nickel, cobalt and rare earths from spent Ni-MH bat-

teries [15,16]. In their research work, the electrode materials were dissolved in 2 MH₂SO₄ at 95°C with a leach efficiency of 97% Ni, 100% Co and 96% RE. The rare earth values were recovered from the leach liquor by solvent extraction with 25% D2EHPA, followed by precipitation with oxalic acid and calcination. The cobalt and nickel in the raffinate were then separated by 20% Cyanex 272 and recovered as oxalates by the addition of oxalic acid. More recently, Tzanetakis and Scott also used D2EHPA to extract rare earths from the leach solution, then nickel and cobalt powders were separated and recovered through electrochemical deposition [17]. Unfortunately, none of these researches is feasible and economical processes due to environmental problem and high cost resulted from various toxic aqueous solutions.

Therefore, an objective of the present study is to develop new recycling process for recovering valuable metals from spent nickel-metal hydride batteries, which is eco-friendly and cost-saving process with thermal treatment as well as classification unlike previously developed leaching operations to dissolve all materials from the electrodic powders. Owing to newly proposed thermal treatment technique, it is possible safely to handle the spent lithium ion batteries and efficiently concentrate the valuable metals in the electrodic powders.

2. Experimental

Spent nickel-metal hydride batteries were used in this study, and especially same brand batteries have been used to

* EXTRACTIVE METALLURGY GROUP, KOREA INSTITUTE OF GEOSCIENCE AND MINERAL RESOURCES, DEAJEON 305-350, KOREA

** DEPARTMENT OF ARCHITECTURAL ENGINEERING, PUKYONG NATIONAL UNIVERSITY, BUSAN 608-737, KOREA

*** DEPARTMENT OF METALLURGICAL ENGINEERING, PUKYONG NATIONAL UNIVERSITY, BUSAN 608-739, KOREA

† Corresponding author: jeipil.wang@gmail.com

maintain the reproducibility of experiments. Ni-MH batteries have been developed in a variety of sizes, ranging from button cells, with a capacity of a few mAh, to large prismatic cells, with a capacity of up to 200 Ah. The construction of Ni-MH cell is very similar to that of corresponding nickel-cadmium types. Ni-MH battery replaced cadmium (Cd) electrode of the existing Ni-Cd battery by a hydrogen storage alloy, where a hydrogen storage alloy (M) is employed for the cathode, along with nickel hydroxide (Ni(OH)₂/NiOOH) for the anode, and alkali-resistant nylon non-woven fabric as in Ni-Cd batteries, polypropylene non-woven fabric and polyamide non-woven fabric for the separator. In addition, for the electrolyte, 5~8 M KOH aqueous solution with a maximized ionic conductivity is in use. Cross-sectional drawings of a button cell and of a cylindrical cell are shown in Fig. 1 [18]. Cylindrical cells are constructed with thin, flexible, spirally wound electrode. Positives are either of the conventional sintered type, or manufactured by applying a paste containing nickel hydroxide, cobalt oxide, and other additives [1]. AB₅-type negative electrodes are manufactured by pasting a mixture of hydrogen storage alloy, a conducting agent and a polymeric binder into nickel foam or nickel felt. Button cells make, in most cases, of pressed powder type electrodes, which are enveloped by means of a nickel screen. The positive electrode is pressed from a mixture of nickel hydroxide, cobalt oxide, and other metal oxide additives [1] and conducting agent, such as graphite or nickel powder. The negative electrode is pressed from a hydrogen storage alloy usually of the AB₅-type, mixed with additives and binders.

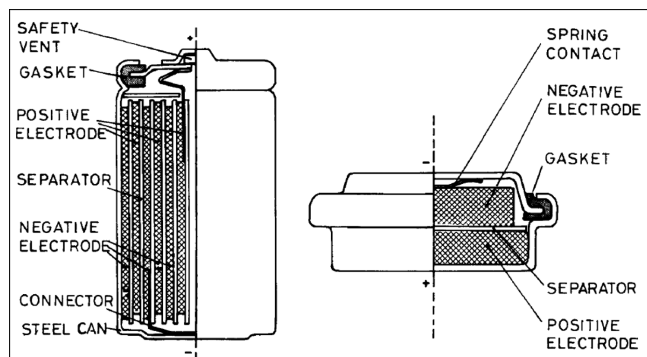
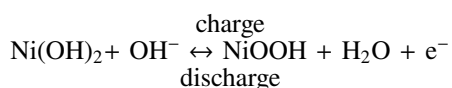

Fig. 1. Schematic structure of a NiMH cylindrical cell and Ni-MH button cell [18]

Nickel metal hydride batteries normally employ nickel hydroxide for the positive electrode. The hydrogen is stored in a hydrogen-absorbing alloy for the negative electrode, and an aqueous solution consisting mainly of potassium hydroxide for the electrolyte. The electrochemistry of the nickel-metal hydride battery is generally represented by the following charge and discharge reactions [19]:

At the positive electrode:



At the negative electrode:

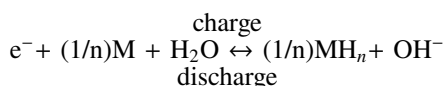

The cell reaction is thus:

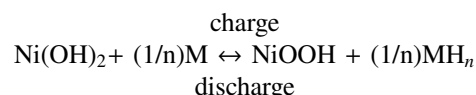

Where, M stands for the hydrogen storage alloy and n is the maximum stoichiometric number for H in the hydrogen storage alloy.

Experimental device newly designed for thermal treatment to concentrate valuable metals is shown in Fig. 2. It illustrates a side view of the main reactor and a top view of the cover for thermal treatment furnace employed for the present process. The electric furnace (1) has been devised to treat mixed spent batteries in a stable manner and to efficiently treat the electrolyte and its gas produced in the closed system. Since the reactor should be able to withstand explosiveness generated in the thermal treatment process and requires a material with high heat- and corrosion- resistance. The reactor was made of SUS 3103S, since it has an excellent heat- and corrosion- resistance as well as concentrated acetic acid resistance along with good formability and weldability. In particular, it has an excellent resistance to high-temperature oxidation and strength due to its high Ni-Cr contents. Heating element (2) is made of SiC material, which enables the temperature to be raised up to 1500°C. The cover for the electric furnace is also made of SUS 310S material, consisting of 3ea of gas outlet (5), thermocouple (4), gas inlet (6), vacuum tube (11), water cooler tube (7). And to prevent inflow and outflow of inside and outside gas to and from the reaction furnace and the cover, O-ring (8) is installed, while water cooler tube (7) was placed above and below so that the O-ring may withstand high temperatures during the experiment.

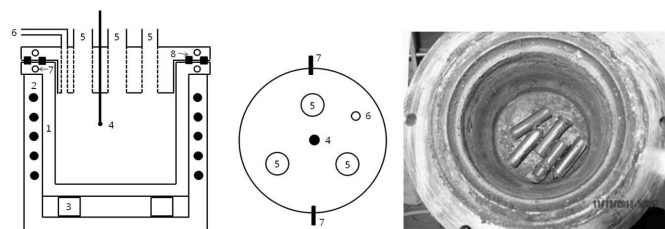

Fig. 2. A schematic diagram for thermal treatment furnace newly proposed

Newly proposed recycling process to recovery of electrochemical powder enriched in various metal values was shown in Fig. 3. This process mainly focused on preventing explosion of batteries by thermal treatment under inert atmosphere, since the oxidation of metallic compositions in a presence of air during thermal treatment might result in dramatic reaction able to produce dangerous explosion. End-of-life spent batteries were collected and charged in steel vessel as a container. Thermal treatment in this work was performed at different temperatures from 300°C to 600°C for 2 hours in electric furnace with SiC heater. Spent batteries were placed inside the reactor which was completely sealed and ultra high-purity argon was injected at a rate of 3 liter/min to maintain inert atmosphere inside the furnace during experiments. Temperature was raised at 10°C/min and maintained for 2 hours once the target temperature was obtained. After thermal treatment, temperature was lowering at a rate of 10°C/min up to room temperature.

A sieving operation was carried out to separate fine powders (electrode powder) less than $105\ \mu\text{m}$ (75 mesh) from bulk components containing several pieces of metals. The collected powders were sent to have further extracting process by chemical leaching, while the larger fractions were sent to further separating operations where ferrous metals, non-ferrous metals, and non-metals were separated by an Eddy Current Separator. To remove organic solvents present in the powders, another heat treatment was conducted to remove them completed by maintaining the temperature at 200°C for 2 hours using a muffle furnace.

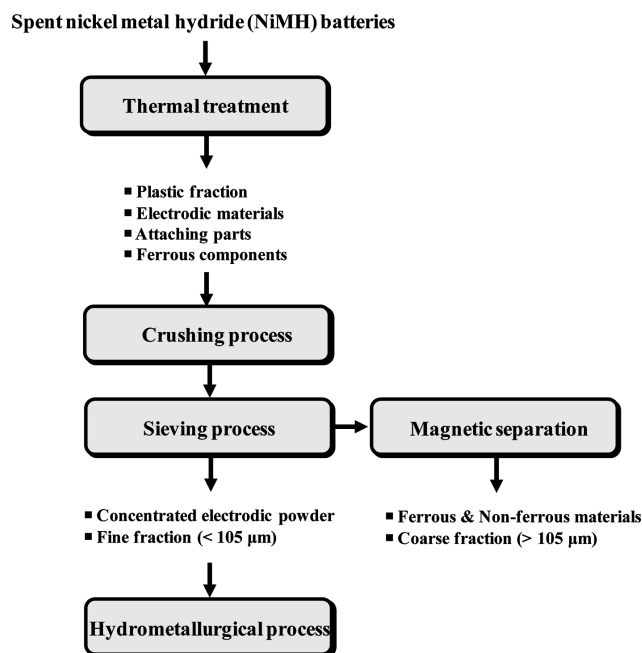

Fig. 3. Proposed flowsheet for recycling spent NiMH batteries using thermal treatment process

3. Results and discussion

Spent Ni-MH batteries from the same brand manufacturer were heated at different temperatures from 300°C to 600°C shown in Fig. 4. As a result of thermal treatment for 2 hours at each temperature, it was found that electrode powder, steel can, separator as well as metal case were completely separated each other inside reactor after experiment. The sheath and label of batteries were completely removed during thermal treatment, and electrode powders were found to be erupted out of the torn battery case. Regardless of an increase of temperature, spent batteries were easily disintegrated and

battery's components were found to be separated each other above 300°C , which might be enough temperature for thermal treatment stage. Especially, the nickel-metal hydride battery (NiMH) has safety valve inside the battery, and this device is a return-type safety valve to temporarily discharge the gas at a specified pressure to prevent danger when the pressure inside battery is increased. Namely, when internal pressure is raised at a high temperature, the safety valve is considered to have discharged the gas inside so that no explosion may occur at high temperatures.

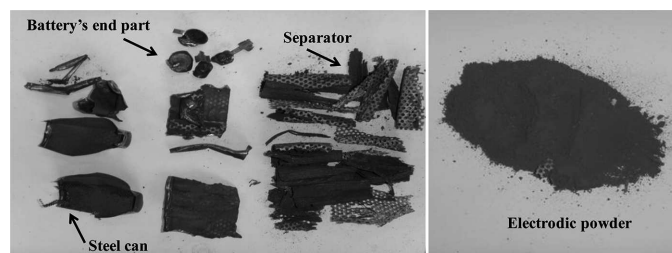

Fig. 4. Component and electrode powder obtained after thermal treatment

Overall recycling process to separate electrode powder from components of spent batteries was shown in Fig. 5. Spent NiMH batteries were fed into the electric furnace and thermal treatment was conducted at 500°C for 2 hours. Explosion was taken place inside reactor during test and then samples including battery component were taken out of the furnace. The samples that underwent crushing processes became small pieces of materials including fine electrode powder. Continually, the classification process was carried out to screen concentrated powders from various components of spent batteries using sieving machine. The electrode powders less than $75\ \mu\text{m}$ were recovered using a sieve with 105 mesh, while for other batteries' components such as metal cases, caps, bottoms, separator, and electrode foil were left behind on the sieve due to oversize.

For the electrode powders concentrated in the classification process, an analysis of chemical composition was conducted with atomic absorption spectroscopy (AA) and energy dispersive X-ray spectroscopy (EDS) and the results were stated in Fig. 6. According to the AA analysis result, it may be seen that nickel (Ni) accounted for about 45 wt.% of the total amount and lanthanum (La) was also contained by 8.0 ~9.0 wt.% and about 4.0 wt.% of cerium (Ce) regardless of temperatures. The EDS mapping was conducted for concentrated powder, and Ni, Co, La, and Ce were observed as the

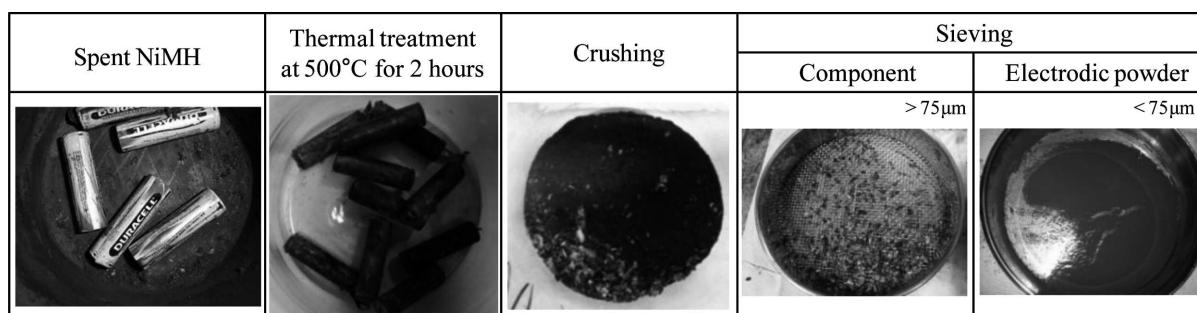

Fig. 5. Overall process to obtain electrode powder using thermal treatment method

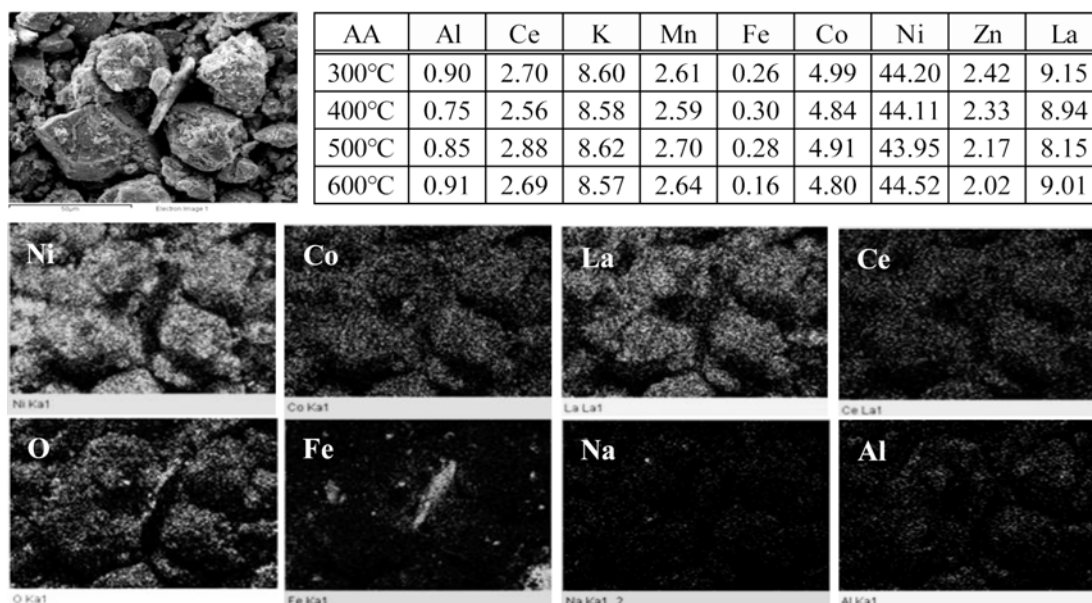

Fig. 6. Chemical composition of electrodic powder analyzed by AA and EDS

major composition. This is may be expected to be the result of concentration from positive electrodes with a mixture of nickel hydroxide ($\text{Ni}(\text{OH})_2/\text{NiOOH}$), cobalt oxide (CoO), and other metal oxide additives in the powder. Particularly, in the case of La and Ce, they are rare-earth metals added upon producing hydrogen storage alloys, and these additives have been widely used for improvement of chemical and physical performance of hydrogen storage alloys.

$\text{LaF}_3\text{-}1.5\text{NH}_3$. The compounds are divided into groups classified by A_xB_y based on their composition and crystal structure. Typically, the A and B components can consist of a number of different elements in varying ranges of stoichiometry. Conventional active materials for negative electrode of AB_5 -type are LaNi_5 with A of mischmetal, La, Ce, Ti and B of Ni, Co, Mn, Al. Therefore, the electrodic powder concentrated mainly consists of nickel and nickel oxide as well as hydrogen storage materials.

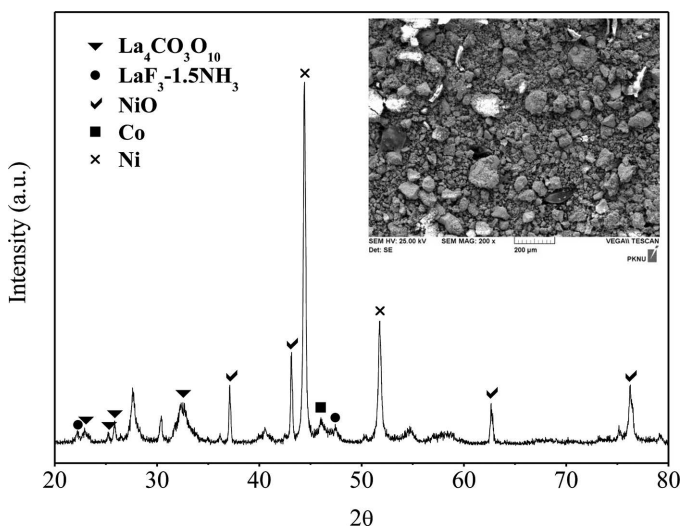

Fig. 7. XRD patterns and SEM image of electrodic powder obtained at 500°C

The electrodic powder obtained after thermal treatment at 500°C for 2 hours was examined by X-ray diffraction (XRD) and the image of powder was taken by scanning electron microscopy (SEM) shown in Fig. 7. It was found that major peaks are observed to be nickel (Ni) and nickel oxide (NiO), which would be resulted from positive electrode of nickel hydroxide (NiOOH) as well as conducting agent made of nickel form and nickel felt. Other patterns of XRD observed in Fig. 7 were found to be intermetallic compounds such as $\text{La}_4\text{CO}_3\text{O}_{10}$ and

4. Conclusion

Newly proposed recycling process to recover valuable materials in the electrodic powder from the spent nickel-metal hydride batteries (NiMH) has been conducted by thermal treatment method at different temperatures under inert atmosphere. Finally, metal values such as nickel of about 45 wt.% and rare earth elements (La and Ce) of about 12 wt.% were concentrated in the electrodic powder. With thermal treatment process, the end-of-life lithium ion batteries could be treated in a stable manner, and explosion risks and environment problems could be resolved effectively as well.

Acknowledgements

This study was supported by the R&D Center for Valuable Recycling (Global-Top Environmental Technology Development Program) funded by the Ministry of Environment. (Project No.:GT-11-C-01-060-0).

REFERENCES

- [1] P. Ruetschi, F. Meli, J. Desilvestro, J. Pow. Sour. **57**, 85-91 (1995).
- [2] T. Kanamori, M. Matsuda, M. Miyake, J. Hazard. Mater. **169**, 240-245 (2009).
- [3] L. Li, S. Xu, Z. Ju, F. Wu, Hydrometallurgy **100**, 41-46 (2009).

- [4] K. Larsson, C. Ekberg, A. Ødegaard-Jensen, *Hydrometallurgy* **129-130**, 35-42 (2012).
- [5] G. Granata, F. Pagnanelli, E. Moscardini, Z. Takacova, T. Havlik, L. Toro, *J. Pow. Sour.* **212**, 205-211 (2012).
- [6] V. Innocenzi, F. Veglio, *Hydrometallurgy* **129-130**, 50-58 (2012).
- [7] M.S. Gasser, M.I. Aly, *Int. J. Miner. Process.* **121**, 31-38 (2013).
- [8] P.V.M. Dixini, V.G. Celante, M.F.F. Lelis, M.B.J.G. Freitas, *J. Pow. Sour.* **260**, 163-168 (2014).
- [9] T. Kuzuya a, S. Hirai, V.V. Sokolov, *Sep. Purif. Technol.* **118**, 823-827 (2013).
- [10] J. Nan, D. Han, M. Yang, M. Cui, X.H.L. Li, S. Xu, Z. Ju, F. Wu, *Hydrometallurgy* **84**, 75-80 (2006).
- [11] J.P. Wang, S.M. Shin, S.H. Joo, D.W. Lee, J.Y. Yun, *J. Korean Pow. Metal. Int.* **20**, 60-67 (2013).
- [12] J.W. Lee, D.W. Kim, S.T. Jang, *J. Korean Pow. Metal. Int.* **21**, 131-136 (2014).
- [13] J.A.S. Tenorio, D.C.R. Espinosa, *J. Pow. Sour.* **108**, 70-73 (2002).
- [14] R. Wang, J. Yan, Z. Zhou, X.P. Gao, D.Y. Song, Z.X. Zhou, *J. Alloys Compd.* **336**, 237-241 (2002).
- [15] P.W. Zhang, T. Yokoyama, O. Itabashi, Y. Wakui, T.M. Suzuki, K. Inoue, *Hydrometallurgy* **50**, 61-75 (1998).
- [16] P.W. Zhang, T. Yokoyama, O. Itabashi, Y. Wakui, T.M. Suzuki, K. Inoue, *J. Pow. Sour.* **77**, 116-122 (1999).
- [17] W.G. Zhang, W.Q. Jiang, L.M. Yu, Z.Z. Fu, W. Xia, M.L. Yang, *Int. J. Hydrogen Energy* **34**, 473-480 (2009).
- [18] T. Muller, B. Friedrich, *J. Pow. Sour.* **158**, 1498-1509 (2006).
- [19] D.C.R. Espinosa, J.A.S. Tenorio, *J. Pow. Sour.* **157**, 600-604 (2006).

Received: 20 November 2014.