

DOI: 10.1515/amm-2016-0016

D. KOTTFER*[#], M. FERDINANDY**[#], L. KACZMAREK***[#], P. TREBUŃA****[#], P. HVIŽDOŠ**[#]

THE STUDY OF SELECTED PROPERTIES OF Ti EB PVD COATING DEPOSITED ONTO INNER TUBE SURFACE AT LOW TEMPERATURE

This study investigates the selected properties of the thin Ti coating applied by activated evaporation EB PVD technique. This technique was used for the deposition of Ti thin coating onto inner surface of OKhN3 MFA steel tubes. Deposition process was carried out at temperature 200°C. Conventional type of coatings – monolayer Ti – was analyzed by standard techniques for surface status and quality assessment – coating thickness, chemical composition by EDX analysis, adhesion, hardness, roughness, and growth direction of columns at room temperature. Ti monolayer achieved roughness Ra equal from 0.42 μm to 0.47 μm. The resulting hardness was from 2 GPa to 8.5 GPa depending on the sample location inside the vacuum chamber. Placing of the coated surface also affected the direction of grain growth of Ti coating columns. The angles α of grain growth were found to be from 40° to 60°. Angle α increased two to three times more than the incidence angle β (from 12° to 28°) of evaporated Ti particles. Values of the adhesion measured along the Ti growth direction were mostly higher (up to 10%) or the same as those measured perpendicular to it.

Keywords: Ti coating; properties; hardness, Young's modulus; growth direction of coating columns

1. Introduction

Properties of Ti coatings have been studied extensively [1-15]. Ti coatings have low hardness, high COF that is why they are not used as functional layers. On the other hand Ti coatings have good adhesion and suitable thermal expansion which makes them good materials for interlayer used to improve adhesion of the functional layers [1,2,8,11-13].

S. Kataria et al. [4] studied selected mechanical properties of Ti thin films deposited by magnetron sputtering PVD technique on D9 steel. The film hardness measured at the surface of the coatings exhibited a value of 2.5 GPa. Adhesion (critical load to failure by delamination) for this coating was evaluated at 2 N. Additionally, S. Kataria et al. [5] evaluated tribological and deformation behavior of titanium coating under different sliding contact conditions. Three different loads of 1 N, 3 N and 9 N and three different speeds 0.1, 0.5, and 2.0 cm/s were used at each load to study the effect of speed on the tribological behaviour of Ti coating. The counterparts were Al₂O₃, Si₃N₄ and steel balls with diameter 6 mm. A tribometer (CSM Instruments, Switzerland) was used in linear reciprocating mode to carry out frictional tests. The roughness and hardness of as deposited Ti coatings were 38.5 nm and 2.5 GPa. Moreover, N. Chelliah and S.V. Kailas [6] studied synergy between tribo-oxidation and strain rate response on governing the dry sliding wear behavior of titanium and found values of

hardness and Young's modulus 1.65 GPa and 104 GPa, respectively. Three loads 15.3 N, 45.8 N and 76 N were used at five sliding speeds 0.05 m/s, 0.1 m/s, 0.45 m/s, 1.0 m/s and 1.4 m/s. The sliding distance was 1500 m. COF values were from 0.39 upward.

B. Bhushan and B. K. Gupta in [7] presented values of hardness and COF of Ti coating equal to 2.3 GPa and 0.8, respectively. Similar results received Jamal et al. [8]. They measured hardness and COF of Ti interlayer equal to 2.3 GPa and 0.765, respectively. On the other hand, Randall in [9,10] shows values of hardness and Young's modulus of Ti coating equal to 16 GPa and 270 GPa, respectively. K. Chu et al. [11] evaluated structural and mechanical properties of titanium and titanium diboride monolayers and Ti/TiB₂ multilayers. They measured hardness and Young's modulus of Ti interlayer 12.5 GPa and 185 GPa, respectively.

J. Xu et al. [12] studied a structure, hardness and Young's modulus of Pd/Ti nanostructured multilayer films, where measured hardness and Young's modulus of Ti interlayer 8.6 GPa and 150 GPa, respectively.

G.S.Kim et al. [13] investigated effects of the thickness of Ti buffer layer on the mechanical properties of TiN coatings. Hardness and Young's modulus were 8.2 GPa and 220 GPa, respectively.

A.A. Voevodin et al. [14] evaluated design of a Ti/TiC/DLC functionally gradient coating based on studies of structural transitions in Ti–C thin films. Ti coating was prepared by

* TECHNICAL UNIVERSITY OF KOSICE, MÄSIARSKA 74, DEPARTMENT OF TECHNOLOGY AND MATERIALS, FACULTY OF MECHANICAL ENGINEERING, 040 01 KOŠICE, SLOVAK REPUBLIC

** SLOVAK ACADEMY OF SCIENCES, INSTITUTE OF MATERIALS RESEARCH, WATSONOVA 47, 040 01 KOŠICE, SLOVAK REPUBLIC

*** TECHNICAL UNIVERSITY OF LODZ, INSTITUTE OF MATERIAL SCIENCE AND ENGINEERING, 90-924 LODZ, STEFANOWSKIEGO 1/15, POLAND

**** TECHNICAL UNIVERSITY OF KOSICE, DEPARTMENT OF INDUSTRIAL ENGINEERING AND MANAGEMENT, FACULTY OF MECHANICAL ENGINEERING, NEMCOVEJ 32, 042 00 KOŠICE, SLOVAK REPUBLIC

[#] Corresponding author: daniel.kottfer@tuke.sk

a hybrid of magnetron sputtering and pulsed laser deposition. They measured values of hardness and Young's modulus of Ti interlayer to be 4 GPa and 175 GPa, respectively.

K. Miyoshi et al. [15] studied sliding wear and fretting wear of diamond like carbon-based, functionally graded nanocomposite coatings. Hardness and Young's modulus of 50 nm thick Ti interlayer deposited onto AISI 440C stainless steel were 4 GPa and 140 GPa, respectively.

Mansour Bozorg et al. [16] studied deposition of titanium film on H-13 steel substrate at 470°C - 530°C using PECVD method. They obtained Ti layer about 2.6 μm thick. Its hardness depending on the pressure, voltage, Ar flow and H flow were from 1.6 GPa to 2.5 GPa; 1.6 GPa to 1.8 GPa; 1.48 GPa to 1.63 GPa and 1.1 GPa to 1.62 GPa, respectively.

Voevodin et al. [17] present a Ti interlayer about 50 nm thick where hardness and Young's modulus of α -Ti interlayer are 4 GPa and 140 GPa, respectively. Based on the analysis of literature lacks analysis of the impact angle of incidence of the evaporated particles on the surface and the properties of the coating applied is lacking.

The aim of this work was to determine the selected properties: hardness, Young's modulus, adhesion, thickness and direction of growth of the grains of the thin Ti coating obtained in the EB PVD process of deposition onto inner tube surfaces at low temperature. The material of samples was steel OKhN3 MFA. The obtained Ti coating was tested by selected methods. These methods are in correlation, and together they can give us information about the quality of applied coating. The next aim of the article is to compare the obtained results with the values reported by the above-mentioned authors.

2. Preparation of specimens and experimental procedure

For deposition of Ti coating onto inner tube surface 5 tubes with radii of 100 mm, 110 mm, 120 mm, 130 mm, and 140 mm and with the same length of 150 mm were used. In order to eliminate problems with possible damage of the Ti coating during cutting the tubes to samples the experiment was simplified as follows:

40 sample pieces were prepared and placed in vacuum chamber in positions that corresponded to tube parts which were to be characterized (Fig. 1a,b). Sample dimensions were 30x6x5 mm. Basic properties of coating such as thickness, adhesion, hardness, Young's modulus and growth direction of coating columns were evaluated. These properties were measured on the tube inner surface at specific distance from the crucible with evaporated Ti: 305 mm; 335 mm; 365 mm and 425 mm. In order to evaluate properties in one location pairs of specimens were prepared, which were fixed to the cathode in the vacuum chamber by means of special holders ensuring precise position of the samples (Fig. 1a,b). The deposition of Ti itself ran 4 times, for each distance H from the crucible with Ti and for 5 selected tube radii.

Experimental samples were made of OKhN3 MFA steel. Chemical composition of this steel is in Table 1. Before deposition substrates were mechanically polished to a surface roughness of Ra from 0.40 μm to 0.60 μm and annealed at 400 °C 10 min in protective Ar atmosphere to remove the residual stresses. On the samples where the coating thickness was to be measured on brittle fracture surface, sharp V-notches were cut by electrospark method. The remaining sample thickness was 1 mm. Samples for measuring adhesion, hardness and Young's modulus were left without notches.

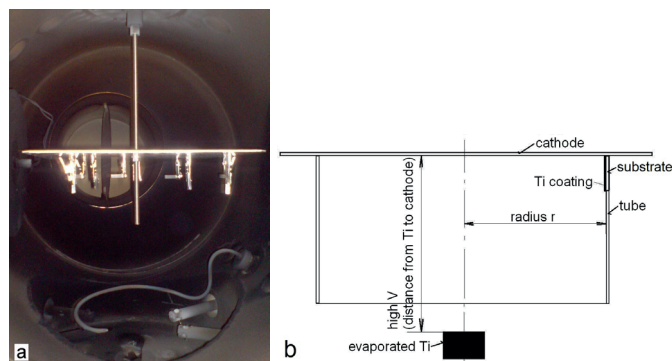

Fig. 1 The location of samples inside the vacuum chamber: actual view (a) and schematic view (b).

Before coating the deposition substrates were cleaned by in ultrasonic cleaner 5 min in acetone and subjected to Ar plasma etching – $P = 0.2$ Pa, $U = 1.2$ kV, $t = 20$ min. and heating – $P = 5$ Pa, $U = 1.24$ kV, $t = 60$ sec.

Ti coating was deposited by activated evaporation by electron beam EBPVD (Fig. 2) according to parameters [3] shown in Table 2. Only one side of the sample was coated. Power of electron gun was 2.5 kW. The temperature of coated surfaces was measured immediately after deposition using K-type thermocouple.

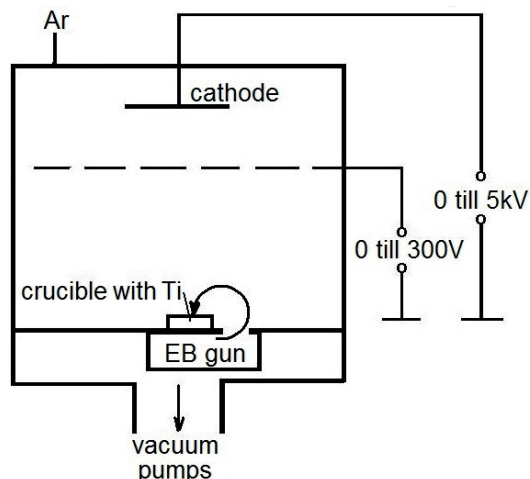

Fig. 2. Schema of the apparatus for activated evaporation using electron beam (EB PVD),

TABLE 1

Chemical composition of OKhN3 MFA steel substrates (ZTS Matec, Slovakia, producer)

Element	C	Mn	Si	Cr	Ni	Mo	S	P	Cu	Sb	V
Wt %	0.360	0.500	0.250	0.820	2.870	0.300	0.004	0.014	0.150	0.007	0.12

TABLE 2

Main process parameters for the Ti coating deposition

Coating	Technique	Pressure [Pa]	Temperature [°C]	I_{catode} [A]	U [V]	Deposition time [min]
Ti	EB PVD	0.01	200	0.2	240	30

The thickness and chemical composition of investigated coatings and substrate were determined by scanning electron microscope Jeol 7000F and EDX. Thickness was measured on the brittle fracture surface of the sample after it was cooled down in liquid nitrogen and broken. The samples were cleaned in ultrasonic cleaner in an organic solvent and then dried by hot air during 3 min.

Direction of grain growth - angle α - of Ti layer was observed on the brittle fracture surface using SEM Jeol 7000F.

Adhesion was evaluated by means of Scratch tester by CSM Instruments and subsequent observation of the scratch in SEM Tesla 340BS. Loading force on a diamond tip indenter was in the range between 1 to 120 N. The table movement was ensured by constant speed of 10 mm. min⁻¹. The scratch track of the tip indenter was 12 mm. Temperature during the test was 22°C.

The surface roughness investigations of samples and deposited coatings were made on device SurfTest SJ-310 MITUTOYO according to STN EN ISO 4287 standard. Length of the track onto evaluated surface was 12.5 mm. Temperature during the test was 22°C.

The microhardness tests of coatings were made on the instrumented CSM ultra microhardness tester using Berkovich indenter tip. Test conditions were selected so that the penetration depth was less than 0.1 of the thickness of evaluated coatings eliminating influence of the substrate on the measurement results. Measurements were made using sinus loading mode with frequency 20 Hz and load up to 0.07 N. Instrumented indentation enables to evaluate hardness as well as Young's modulus.

3. Results and discussion

Experiment was performed to investigate the influence of the radius of tubes and distance from evaporated Ti on selected properties of deposited Ti coating. Measured results are presented in following.

An important parameter of preparation of TiN and Ti layers by EB PVD is the geometric arrangement of the coated surfaces during the coating with respect to the target. Ti is evaporated into the vacuum chamber from crucible by electron beam and can be considered to be a point source. Ti vapors are moving in straight lines from the source, the electric and magnetic fields affect only the trajectories of the ionized particles (0.1% to 10% of the total number of particles falling onto the substrate). Possibilities to regulate the mentioned processes are limited. The mean free path of the particles can be changed by varying the pressure in the vacuum chamber. In that case more collisions per unit of time takes place which leads growth in form of fragile, low adhesive columnar structure. That is why for preparation of TiN coatings lower pressures are preferred [18]. The coating deposition rates can be controllable by changing the electron beam power and the

number of the ionized particles by changing the substrate voltage. The dependence of geometry of the coated tube surfaces on amount of evaporated Ti and vacuum chamber pressure is in Figure 4 [19]. These results follow from research of TiN layers prepared by arc evaporation [18,19].

The evaluated Ti layer was deposited at vacuum chamber pressure 0.01 Pa. Thickness of the obtained layer (Fig. 3a) is in agreement with and its distribution along the tube length is similar to that in Figure 4 left. It had values from 1.3 μm to 3.9 μm (Fig. 5). Chemical composition of the Ti layer (Table 3) carried out by EDX showed that Ti coating contains besides Ti also Fe (Fig. 3b), which came from the substrate because coating is few microns in thick.

Adhesion was assessed by means of scratch testing parallel the grain growth direction (a1) and perpendicular to it (a2). The measured tests were performed from 10 N to 120 N for a1 (Fig. 6a) and from 8 N to 110 N for a2 (Fig. 6b), respectively. Ti coating was deposited at 200°C which is the lowest temperature limit interesting for practical deposition. Adhesion values close to 50 N and higher were found. Those measured along the Ti growth direction were mostly higher (up to 10%) or the same as those measured perpendicular to it. The track after scratch testing of samples with values close to 50 N shows adhesive and cohesive failure of Ti coating (Fig. 7). Because of low deposition temperature it can be assumed that for temperatures above 200 °C the adhesion values can grow to 50 N and more. Adhesion values over 50N are considered to be satisfactory according to D7187 standard.

Ti layer grow in columnar grain structure as reported in [1]. Its density varied as confirmed by hardness values. The higher the hardness the higher the coating grain density (see arrows - Fig. 8b). Coatings with lower hardness have a large number of micro and nanogaps (Fig. 8b). Their columns have diameter about 10 nm. On the other hand coatings with the hardness 8.5 GPa have only nanogaps (Fig. 8a). Also diameter of columns is larger – about 15 nm. Macro, micro and nanogaps in coatings were described by Mesier et al. [20] and Ensinger [21]. The coating growth angle α (Fig. 9b) had values from 40° to 60° (Tab. 4), which with respect to the angle of incidence β (Fig. 9a) being from 12° to 28° is considered satisfactory. Values of α increased with increasing distance V , radius r , i. e. with the increasing of the incidence angle β .

Roughness R_a of the experimental surfaces was measured using roughness tester SurfTest 301 by Mitutoyo before and after deposition of Ti coating. The roughness values were calculated as average from 3 to 5 measurements. Roughness of substrate was from 0.42 μm to 0.47 μm . Roughness after the deposition of Ti layer was from 0.42 μm to 0.49 μm (Fig. 10), which means that the PVD layers copy the substrate surface and keep the roughness unchanged. Generally, roughness of Ti coating can be influenced by roughness of the steel sample and thickness of Ti layer. It can be affected also by local structural irregularities of Ti layer.

Measurements of hardness H (Fig. 11) and Young's modulus E (Fig. 12) of Ti layer were carried out on equipment by CSM Instruments according to the standard ISO 14577. Each value is an average from 5 to 10 measurements. For the hardness of the Ti coating of each sample the maximum measured value was taken and values from 2.0 GPa to 8.5 GPa. The result is 3 to 4 times higher than in [4-6,8,9], twice as high as that in [14,15], in agreement with [12,13,17], 50% lower than in [11] and 100% lower than those reported in [9,10]. The lower values found in this study could be caused by lower density of columns (Fig. 8) and possible structure errors of the coatings (imperfections or pores caused by R_a from 0.42 to 0.49 μm). Higher roughness of sample surfaces (e.g. microdrops embedded into the coating during deposition) can affect the penetrating indenter tip – incorrect contact detection can lead to much higher measured depth of indentation and thus much lower apparent hardness.

Young's modulus of Ti coating was calculated from instrumented indentation unloading curves and the resulting value was found as an average from 5 to 10 measurements. Values of E from 14 GPa to 240 GPa were found. The maximum value is in agreement with [13] and also most of the measured values agree with those reported in [11-15,17].

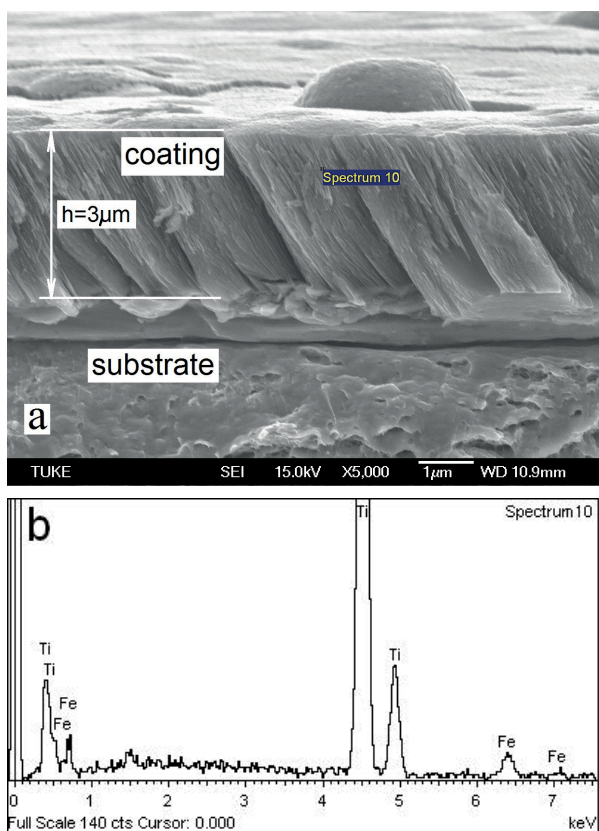

Fig. 3. Thickness h of the Ti coating, cross sectional view (a) and EDX chemical elements analysis (b)

TABLE 3

Chemical compound of the Ti coating

Element	Weight%	Atomic%
Ti K	94.6	95.3
Fe K	5.4	4.5
Totals	100.00	100.00

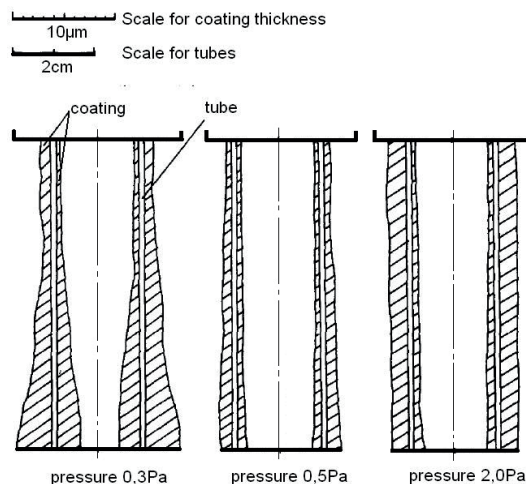

Fig. 4. Growth of layer thickness on the outer and inner surfaces of tube placed vertically to Ti vapors flow at various pressures and amounts of evaporated Ti [19]: (left) 7g Ti, 0.3Pa, (between) 6 g Ti, 0.5Pa, (right) 8.5 g Ti, 2Pa.

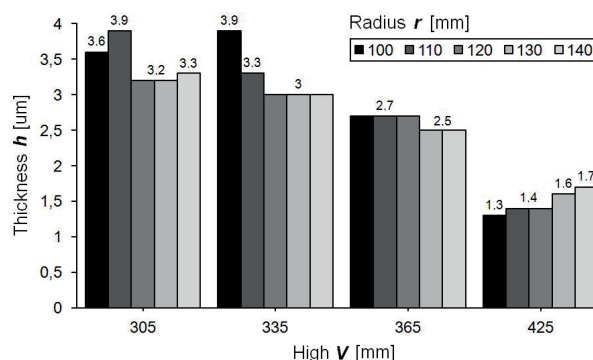

Fig. 5. Thickness h of the Ti coating measured onto different points of tubes (high V and radius r)

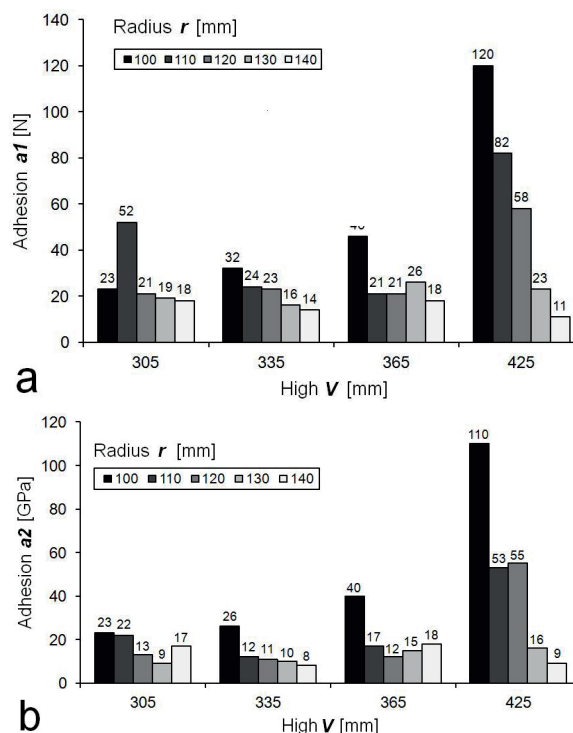

Fig. 6. Adhesion $a1$ measured along the direction of grains (a) and $a2$ measured against the direction of grains $a2$ (b)

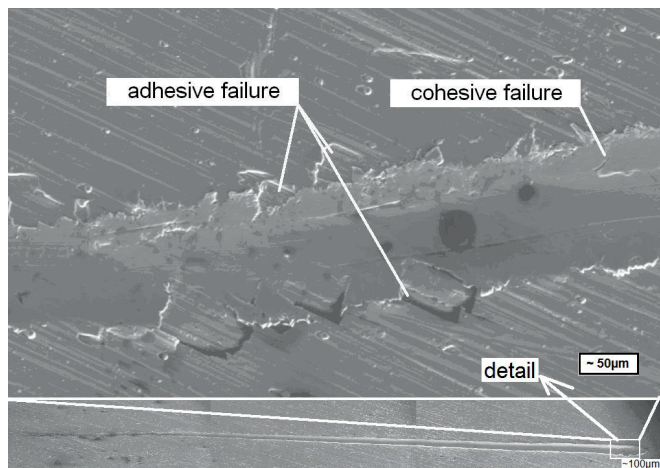

Fig. 7. Track after scratch testing (down), adhesive and cohesive failure of Ti coating (up).

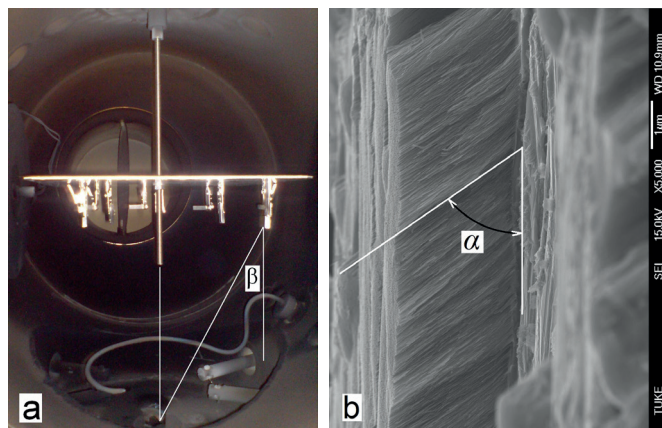

Fig. 9. Angle of incidence β of evaporated Ti particles (a), the growth direction α of coating columns, cross sectional view of the Ti coating (b)

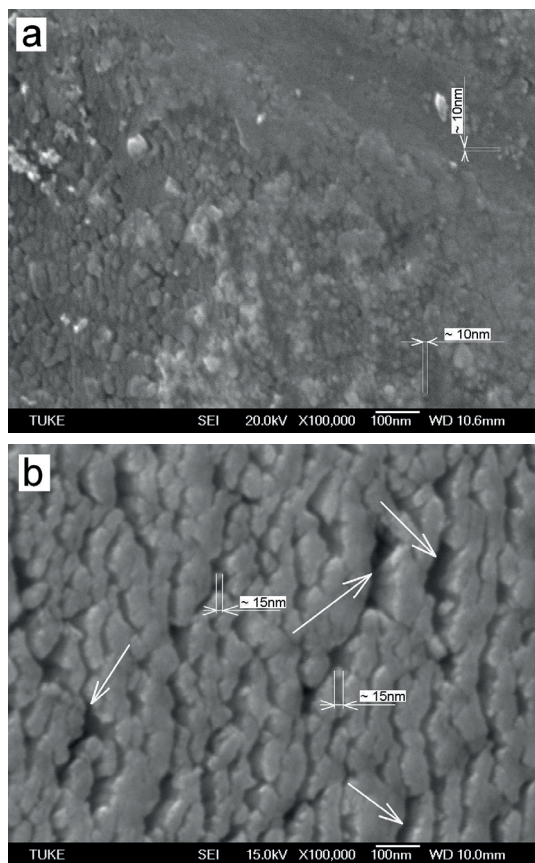

Fig. 8. The front view onto Ti layer (enlarging 100 000x) : (a) density coverage is higher, measured hardness 8.5 GPa, (b) density coverage is lower, measured hardness 2.0 G Pa. Micro and nanogaps (arrows), diameter of grains (see marked)

TABLE 4

Measured values of the angle of Ti grain growth α with respect to distance (high) of target to V cathode and radius r

Radius of tube r [mm]	100	110	120	130	140
Distance target-cathode V [mm]	Angle of grain growth α [°]				
305	59	60	59	57	57
335	57	60	60	60	60
365	50	50	50	45	55
425	40	42	45	45	45

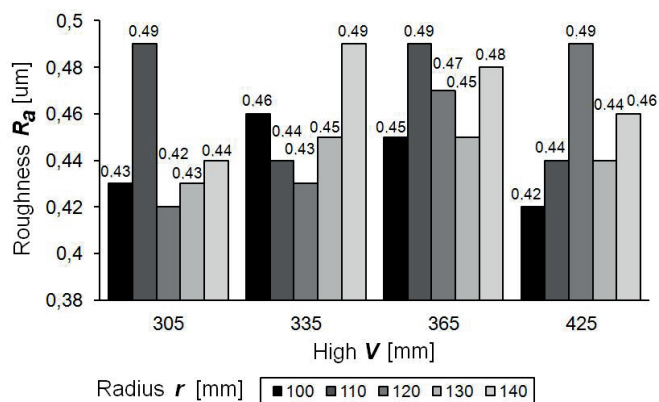

Fig. 10. Roughness R_a of the Ti coating measured onto different points of tubes

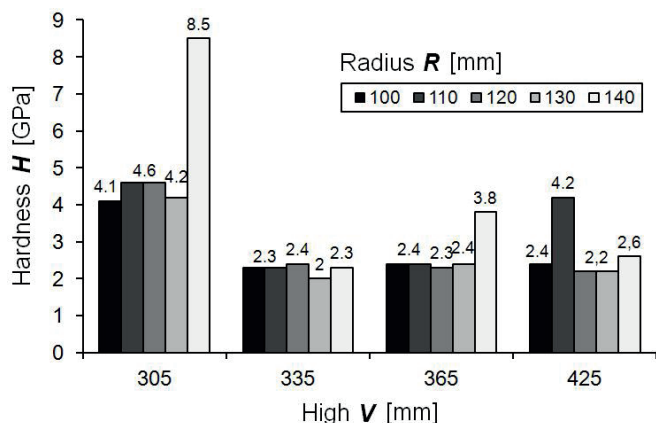

Fig. 11. Hardness H of the Ti coating measured onto different points of tubes.

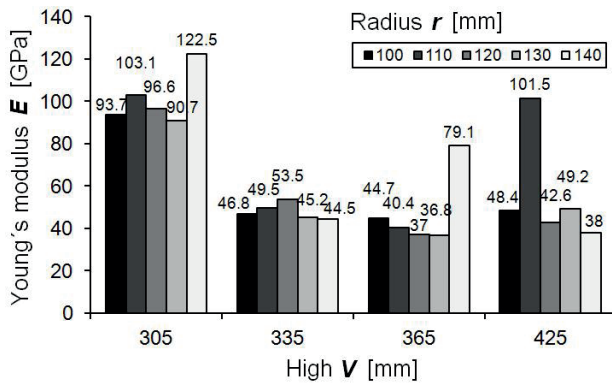

Fig. 12. Young's modulus E of the Ti coating measured at different points of tubes.

4. Conclusions

According to the measurements and following analyses, the findings can be summarized as follows:

- Following properties of Ti coating deposited onto inner tube surface made of OKhN3 MFA steel were evaluated: thickness, adhesion, hardness, Young's modulus, and grain growth direction angle.
- The thickness of the Ti coating was from 1.3 μm to 3.9 μm independently on the distance from evaporated Ti. Thickness growth with increasing of radius and distance from evaporated Ti.
- Values of the adhesion evaluated by scratch test along and the grain growth direction were from 10 N to 120 N and from 8 N to 110 N, respectively. Adhesion decreased with increasing radius. On the other hand adhesion increased with increasing distance from evaporated Ti.
- Ti layer grew in columnar form. Its density was changing which was corroborated by the range of measured hardness values. Also its density was changing with changing of grains size. Values of α increased with increasing distance H , i. e. with increasing incidence angle β . The grain growth angle of Ti coating α was from 40° to 60° , with respect to the incidence angle β which was from 12° to 28° . Angle α increased two to three times more than the angle β .
- The highest hardness values and Young's modulus were 8.5 GPa and 210 GPa, respectively. On the other hand, the lowest values of the hardness and Young's modulus were 2.0 GPa and 14 GPa, respectively. The lower values measured in this study can be a consequence of lower density of columns and bigger diameter of grains-columns.
- Experiments showed that it is possible to deposit a thin Ti layer on the internal tube surface. From the measured results after optimizing the deposition process with respect to selected parameter (e.g. adhesion, angle α close to 90°) parameters of deposition process can be inferred.
- In order to achieve higher isotropy of properties of Ti coating it is necessary to achieve angle α close to 90° , which means that the experiment should be extended further, so that it will be possible to contribute to optimization of deposition process of Ti onto internal surface of the tube.

Acknowledgements

This work was financially supported under the Slovak Grant Agency under the grants APVV-0682-11, VEGA 1/0264/11, 1/0102/11, 2/0061/14, 2/0075/13, KEGA 004TUKE-4/2013 and APVV-0108-12 (ConCer).

REFERENCES

- [1] E. Vassallo, R. Caniello, A. Cremona, D. Dellasega, E. Miorin, Titanium interlayer to improve the adhesion of multilayer amorphous boron carbide coating on silicon substrate, *Applied Surface Science* **266**, 170–175 (2013).
- [2] K. Perzynski, Ł. Major, Ł. Madej, M. Pietrzyk, Analysis of the Stress Concentration in the Nanomultilayer Coatings Based on Digital Representation of the Structure, *Archives of Metallurgy and Materials* **56**, 2 393-399 (2011).
- [3] D. Kottfer, Thin coatings on internal cylindrical surfaces (in slovak), Habilitation, Technical university of Košice, Faculty of mechanical engineering, 2010, p.92,
- [4] S. Kataria, R. Ramaseshan, S. Dash, A.K. Tyagi, Nanoindentation and Scratch Studies on Magnetron Sputtered Ti Thin Films, *J. Nanosci. Nanotechnol.* **9**, 5476–5479 (2009).
- [5] S. Kataria, N. Kumar, S. Dash, A.K. Tyagi, Tribological and deformation behaviour of titanium coating under different sliding contact conditions, *Wear* **269** 797–803 (2010).
- [6] N. Chelliah, S.V. Kailas, Synergy between tribo-oxidation and strain rate response on governing the dry sliding wear behaviour of titanium, *Wear* **266**, 704–712 (2009).
- [7] B. Bhushan, B. K. Gupta, *Handbook of tribology*, McGraw-Hill Inc. ISBN 0-07-005249-2 p. 1069 (1991).
- [8] T. Jamal, R. Nimmagada, R.F. Bunshah, Friction and Adhesive Wear of Titanium Carbide and Titanium Nitride Overlay Coatings, *Thin Solid Films* **73** (1980) 245-254
- [9] N.X. Randall, Finer particle size allows better coating characterisation with the Calotest, *Applications bulletin*, Dokument AB No5, CSM Instruments, Advanced Mechanical Surface Testing, October 1997.
- [10] N. X. Randall, Development and application of a multifunctional nanotribological tool, PhD Thesis, University of Neuchâtel, Switzerland, 1997.
- [11] K. Chu, Y.H. Lu, Y.G. Shen, Structural and mechanical properties of titanium and titanium diboride monolayers and Ti/TiB₂ multilayers, *Thin Solid Films* **516**, 5313–5317 (2008).
- [12] J. Xu, M. Kamiko, H. Sawada, Y. Zhou, R. Yamamoto, L. Yu, I. Kojima, Structure, hardness, and elastic modulus of Pd/Ti nanostructured multilayer films, *J. Vac. Sci. Technol. B* **21**, 6., Nov-Dec (2003).
- [13] G.S. Kim, S.Y. Lee, J.H. Hahn, B.Y. Lee, J.G. Han, J.H. Lee, S.Y. Lee, Effects of the thickness of Ti buffer layer on the mechanical properties of TiN coatings, *Surface and Coatings Technology* **171**, 83–90 (2003).
- [14] A.A. Voevodin, M.A. Capano, S.J.P. Laube, M.S. Donley, J.S. Zabinski, Design of a Ti/TiC/DLC functionally gradient coating based on studies of structural transitions in Ti–C thin films, *Thin Solid Films* **298**, 107–115 (1997).
- [15] K. Miyoshi, B. Pohlchuck, Kenneth W. Street, J.S. Zabinski, J.H. Sanders, A.A. Voevodin, R.L.C. Wu, Sliding wear and fretting wear of diamond like carbon-based, functionally

- graded nanocomposite coatings, *Wear* **225–229**, 65–73 (1999).
- [16] Haman Hedayatmofidi, Alireza Sabour Rouh Aghdam, Shahrokh Ahangarani, Mansour Bozorg, Mahboube Azadi, Maryam Valiei, Deposition of Titanium Layer on Steel Substrate Using PECVD Method: A Parametric Study, *Materials Sciences and Applications* **5**, 140-148 (2014).
- [17] A.A. Voevodin, J.S. Zabinski, C. Muratore, Recent Advances in Hard, Tough, and Low Friction Nanocomposite Coatings, *Tsinghua Science and Technology* **10(6)**, 665-679, December (2005).
- [18] R.L. Boxman, V.N. Zhitomirsky, Vacuum arc deposition devices, *Rev. Sci. Instrum* **77**, 2, 021-101 (2006).
- [19] A. Matthews, A.R. Lefkow, Problems in the physical vapour deposition of titanium nitride, *Thin Solid Films* **126**, 283-291 (1985).
- [20] R. Messier, A.P. Giri, R.A. Roy, Revised structure zone model for thin film physical structure, *J. Vac. Sci. Technol. A* **2** (2), April.-June (1984).
- [21] W. Ensinger: Low energy ion assist during deposition - an effective tool for controlling thin film microstructure, *Nuclear Instruments and Methods in Physics Research B* **127/ 128**, 796-808 (1997).
- [22] Standard ASTM D7187: Test Method for Measuring Mechanistic Aspects of Scratch/Mar Behavior of Paint Coatings by a Nanoscratching. Conshohocken: ASTM International (2005).

Received: 20 January 2015.

