

DOI: 10.1515/amm-2016-0029

J. SŁANIA*#, R. KRAWCZYK*, D. MASŁOŃ**

TECHNOLOGY OF WELDING JOINTS MIXED WITH DUPLEX STEEL

Results of the examinations of sample plates of mixed joints with the duplex steel were discussed. Examinations were taken on the sample plates of mixed joints of sheet plates type P355NL1 and X2CrNiMoN22-5-3 welded by the flux-cored wire DW-329A by the Kobelco company of the following category T 22 9 3 NL RC/M3 in the gas shroud M21 (Ar+18%CO₂) (plate no.1), and nickel covered electrodes E Ni 6082 by the Böhler company (plate no. 2). Results of the side bend test of welded joint, transverse tensile test, stretching of the weld metal, impact strength, micro and macroscopic metallographic examinations, and measurements of the delta ferrite content were presented.

Keywords: welding, duplex steel, mixed joints

1. Introduction

Duplex steel owes its two-phase structure a set of mechanical properties connected with ductility and plasticity as well as a high resistance to different types of corrosion. This material allows to obtain advantages from joining austenite and ferrite phases. Carefully chosen chemical composition guarantees better properties to much more expensive high-alloyed austenite steel [1-7].

Presented examinations in the article were taken on the sample plates of mixed joints of sheet metal type P355NL1 and X2CrNiMoN22-5-3 welded by the flux-cored wire DW-329A produced by the Kobelco company of a following category T 22 9 3 NL RC/M3 in the gas shroud M21 (Ar+18%CO₂) (plate no. 1), and nickel coated electrodes E Ni 6082 by the Böhler company (plate no. 2).

Above experiment was done to prove the properties of a joint made by the filler material of a duplex steel structure, and a high-nickel material, as well as specifying an influence of a thermal treatment on the changes of the duplex steel structure.

2. Properties, chemical composition of materials. Schaeffler's diagram

Table 1. Differences of properties between P355NL1 steel, and resistant to corrosion X2CrNiMoN22-5-3 duplex steel.

On the base of a chemical composition of both metal sheets and used filler materials, expected structures of the welds' materials made during processes were specified. The Schaeffler's diagram was used to illustrate it. (Fig. 1)

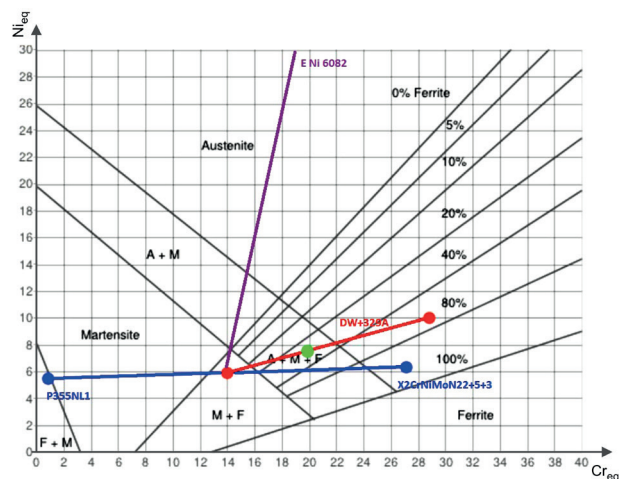

Fig. 1 The Schaeffler's diagram [17]

After calculating an equivalent of chromium and nickel (formula 1, 2) and applying the results to the diagram, following data was obtained:

- an austenite-ferrite-martensite mixed structure with an approximate value of ferrite 10% by using a flux-cored duplex wire.
- a diagram does not cover in its range material of such high content of nickel (clearly shows a plain austenite structure) by using nickel covered electrodes

$$C_{req} = Cr + Mo + 1,5Si + 0,5Nb \quad (1)$$

$$Ni_{eq} = Ni + 30C + 0,5Mn \quad (2)$$

It is necessary to point that the Schaeffler's diagram relates to the constant cooling conditions of the weld, thus a real result

* CZESTOCHOWA UNIVERSITY OF TECHNOLOGY, 69 J.H. DĄBROWSKIEGO STR., 42-200 CZĘSTOCHOWA, POLAND

** FABRYKA APARATURY I URZĄDZEŃ „FAMET” SA, 102C OŚWIĘCIMSKA STR., OPOLE, POLAND

Corresponding author: jacek_slania@poczta.onet.pl

TABLE 1

Comparison of mechanical properties of P355NL1 steel and X2CrNiMoN22-5-3 steel [14]

| Type | | Re, MPa | Rm, MPa | A, % | HB | KV, J (-40°C) |
|-----------------|-----|---------|---------|------|-----|---------------|
| P355NL1 | Min | 395 | 533 | 32.5 | 175 | 101 |
| | Max | 400 | 552 | 33.0 | 183 | 114 |
| X2CrNiMoN22-5-3 | Min | 470 | 739 | 31.6 | 223 | 229 |
| | Max | 472 | 747 | 34.9 | 223 | 240 |

TABLE 2

Chemical composition of X2CrNiMoN22-5-3 metal sheet [14]

| C | Si | Mn | P | S | Cr | Ni | Mo | N | Co |
|-------|------|------|-------|-------|-------|------|------|--------|------|
| 0.026 | 0.45 | 1.42 | 0.029 | 0.001 | 22.26 | 5.11 | 3.12 | 0.1690 | 0.07 |

TABLE 3

Chemical composition of P355NL1 metal sheet [4]

| C | Si | Mn | P | S | Al | Cr | Ni | Mo | Cu |
|-------|-------|-------|--------|--------|-------|-------|-------|-------|-------|
| 0.170 | 0.380 | 1.190 | 0.007 | 0.0029 | 0.033 | 0.180 | 0.014 | 0.004 | 0.160 |
| V | Nb | Ti | B | N | | | | | |
| 0.006 | 0.008 | 0.013 | 0.0003 | 0.0068 | | | | | |

TABLE 4

Chemical composition of the flux-cored wire DW-329A – Kobelco [12]

| C | Si | Mn | P | S | Cu | Ni | Cr | Mo | N |
|-------|------|------|-------|-------|------|------|-------|------|------|
| 0.025 | 0.74 | 0.93 | 0.015 | 0.002 | 0.08 | 9.23 | 23.21 | 3.38 | 0.16 |

TABLE 5

Chemical composition of the ThermanitNicro 82 coated electrode– Böhler [3]

| C | Si | Mn | P | S | Nb | Cr | Ni | Mo | Cu |
|-------|------|------|-------|-------|------|-------|-------|-----|------|
| 0.024 | 0.40 | 5.16 | 0.006 | 0.005 | 2.22 | 18.83 | 69.70 | 1.0 | 0.02 |
| Ti | Fe | | | | | | | | |
| 0.081 | 2.70 | | | | | | | | |

may considerably differ. Above differences result from the dynamics of a welding process, and particularly an influence of heat which is difficult to predict, and the foremost conditions of cooling the weld [8-11].

3. Technology of welding

Welding sample plates was made in the downhand position PA. An initial preheating was not applied, instead, an interpass temperature was kept on the level not higher than 150°C.

An order of applying beads is presented in the picture 2, while the real parameters obtained during the process of welding are included in the table 6.

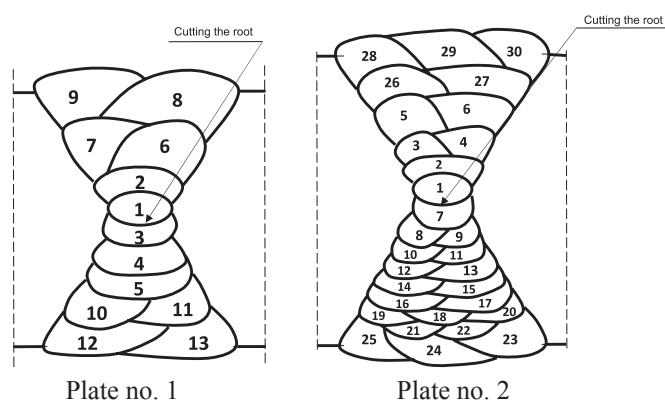

Fig. 2. An order of applying beads

Used parameters allowed to obtain a proper amount of inserted heat (linear energy ranges from 0,3 to 1,7 kJ/mm), does not exceed recommended values (maximum value of a linear energy is 2,5 kJ/mm).

TABLE 6

Real parameters obtained during a welding process

| PLATE NO. 1 | | | | PLATE NO. 2 | | | |
|---------------------------------|---------------------|-------------|-------------------------|---------------------------------|---------------------|-------------|-------------------------|
| No. of bead | Current intensity A | Voltage V | Speed of welding cm/min | No. of bead | Current intensity A | Voltage V | Speed of welding cm/min |
| 1 | 215 | 30.7 | 32.7 | 1 | 91 - 94 | 23.5 – 26.0 | 11,1 |
| 2 - 7 | 235 - 270 | 31.2 – 32.3 | 21.8 – 40.0 | 2 - 7 | 109 - 120 | 23.2 – 27.0 | 14,2 |
| 8 - 9 | 240 - 275 | 32.3 | 24.9 – 29.1 | 8 - 18 | 119 - 131 | 21.5 – 27.3 | 20,0 |
| 10 – 11 | 230 - 275 | 32.3 | 33.8 – 46.2 | 19 - 20 | 112 - 115 | 22.5 – 24.5 | 24,0 |
| 12 - 13 | 250 - 280 | 32.3 | 32.7 – 33.6 | 20 - 26 | 109 - 125 | 23.0 – 26.5 | 21,4 |
| Linear energy of welding, kJ/cm | | | 7.7 – 17.2 | Linear energy of welding, kJ/cm | | | 2,8 – 12,3 |

TABLE 7

Parameters of a thermal treatment after welding

| Type of treatment | Stress relief annealing | | |
|-------------------|---|-----------|------------|
| Material | P355NL1 + X2CrNiMoN22-5-3 | | |
| No. | Actions | Value | [unit] |
| 1 | Place in the furnace in the maximum temperature | 300 | [°C] |
| 2 | Heat gradually to the temperature | 570 ÷ 590 | [°C] |
| 3 | Maximum speed of heating | 100 | [°C/hour.] |
| 4 | Time of annealing | 30 | [min] |
| 5 | Cool in the furnace up to the temperature | 350 | [°C] |
| 6 | Maximum speed of cooling | 100 | [°C/hour.] |
| 7 | Afterwards, cool in the mild air | Yes | - |

4. Thermal treatment after welding

After welding a thermal treatment – stress relief annealing was applied (table 7) in order to delete welding stress. Then, non-destructive and destructive testing were done, and their results are presented later in the article.

5. Non-destructive testing.

VT – visual testing

The first non-destructive testing, including 100% of the length of the examined welded joint is a visual testing, which is done according to the PN-EN ISO 17637 standard. During examination there were not any of disqualifying discrepancies specified in the PN-EN ISO 5817 standard.

PT – penetration testing

There was a penetration testing done according to the EN ISO 571-1 standard after visual testing. Mr. Chemie GMBH products were used.

Examination included 100% of the welded joint, there were not any discrepancies.

RT – radiographic testing

The only volume examination which was taken was a radiographic testing according to the PN-EN ISO 1435 standard. The whole area of the joint during examination together with the base material was taken into account, except 20 mm scraps on both sides.

SMART 300HP ANDREX lamp was used, as well as X-ray film IX100 by the Fuji Film.

Radiographic images did not reveal any welding discrepancies.

6. Collecting and preparing samples to destructive testing.

A way of collecting samples according to the PN-EN ISO 15614-1 is depicted in the picture 3.

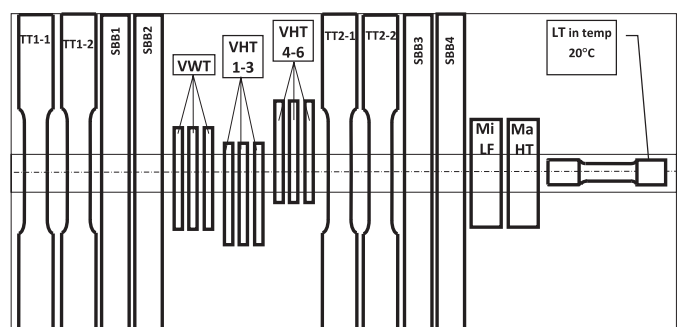

Fig. 3. Places of collecting samples from the sample plates. TT – tension-torsion, SBB – surface band bending, Mi – micro, Ma – macro, VWT, VHT – notch impact value, HT – hardness testing, LF – ferrite number, LT – tension of weld metal [15,22]

Whereas the methods of preparation, a scheme of taken examinations, and their results are presented underneath. All the examinations were taken in exactly the same conditions in case of both sample plates.

7. Side bend test

The test was done according to the PN-EN ISO 5173 standard on four lateral samples (fig. 4). A bending mandrel of 40 mm diameter was used. A traditional machine ZD40 used to stretch of a maximum power 400 kN was used [28].

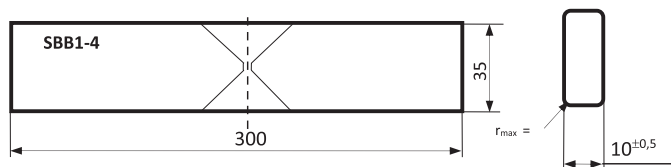
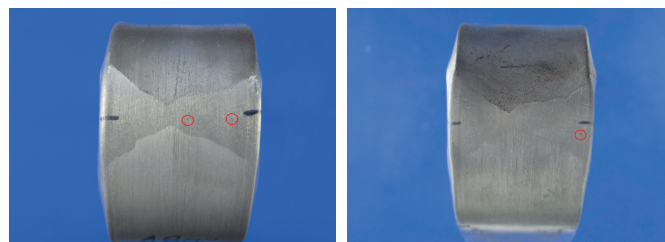

Fig. 4. A way of preparing samples to the side bend [18]

Pictures of the samples after side bend are presented in the picture 5.



SBB4 – Plate 1 – 136 SBB4– Plate 2 – 111

Fig. 5 Pictures of the samples after side bend

Bending tests did not reveal any discrepancies in the base materials, welds and heat-affected zones. In case of both sample plates there appeared only slight cracks, which do not disqualify the joint. A result of an examination was positive (table 8, Fig. 5)

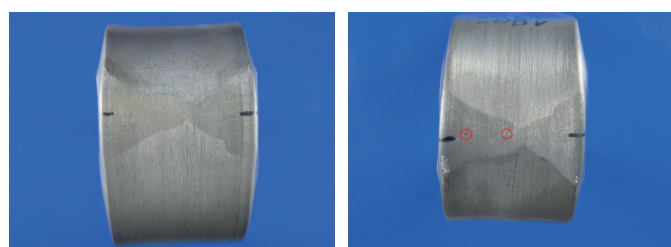

SBB1 – Plate 1 – 136 SBB1 – Plate 2 – 111

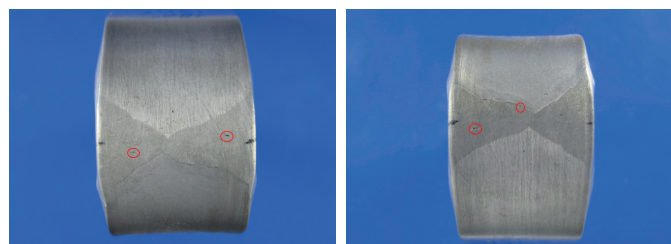

SBB2 – Plate 1 – 136 SBB2 – Plate 2 – 111

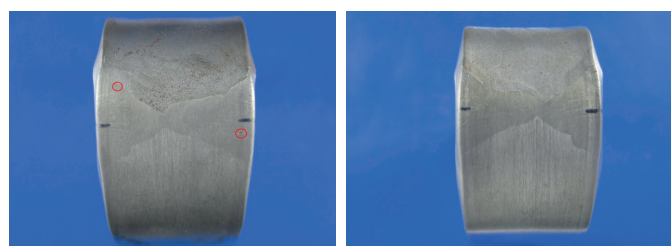

SBB3 – Plate 1 – 136 SBB3 – Plate 2 – 111



Fig. 6. A phenomena of non-axial deformation of bent samples

It is vital to point that PN-EN ISO 15614-1 standard allows to use 2 tests of bending longitudinal samples instead of 4 tests of side bend in case of mixed joints. It is done to avoid a problem of non-axial deformation of samples during examination, which is caused by too high difference of a resistance and plasticity of both materials. It was observed in the above experiment (Fig. 6). Above test was done in order to examine the joint in difficult technological conditions, therefore more risky 4 side bends were made [15, 18, 22].

8. Transverse tensile test

Transverse tensile test was done on four samples prepared according to the picture 7 in the room temperature in accordance with the PN-EN ISO 4136 standard. Sizes of the samples were fixed to the possibilities of the tensile testing machine of 400kN power. Taking into account a high tensile

TABLE 8

Results of the side bend tests

| Sample | An angle of bend, ° | Plate 1 (136) | Plate 2 (111) |
|--------|---------------------|-----------------------------|------------------------------|
| SBB1 | 180 | Lack of cracks | Openings I1=0.2mm. I2=0.8 mm |
| SBB2 | 180 | Openings I1=1.2mm. I2=0.4mm | Openings I1=1.7mm. I2=0.5 mm |
| SBB3 | 180 | Openings I1=0.7mm. I2=1.2mm | Lack of cracks |
| SBB4 | 180 | Openings I1=1.5mm. d=0.5mm | Opening I1=1.3mm |

TABLE 9

Results of the tension tests

| Sample | Plate 1 - 136 | | Plate 2 - 111 | |
|--------|---------------|------------------|---------------|------------------|
| | Rm, MPa | Breaking place | Rm, MPa | Breaking place |
| TT1-1 | 536 | P355NL1 material | 557 | P355NL1 material |
| TT1-2 | 525 | P355NL1 material | 558 | P355NL1 material |
| TT2-1 | 520 | P355NL1 material | 559 | P355NL1 material |
| TT2-2 | 524 | P355NL1 material | 546 | P355NL1 material |

strength of the duplex steel, it was necessary to take two samples from the joint. A minimum criteria for the joint was equal to 470MPa [23].

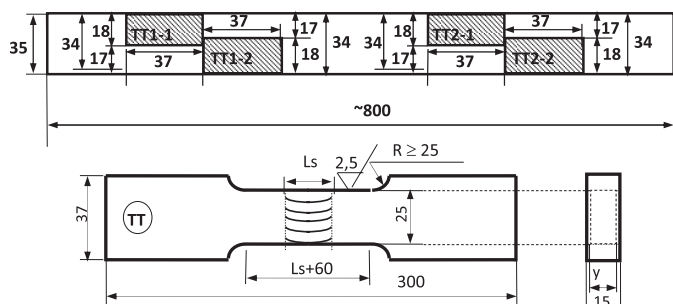
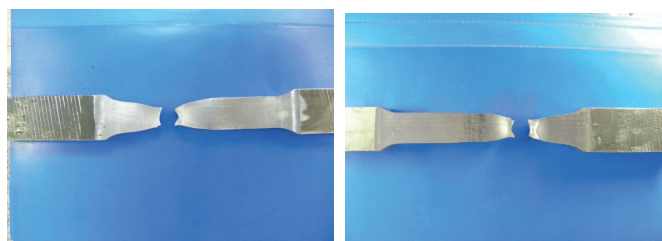
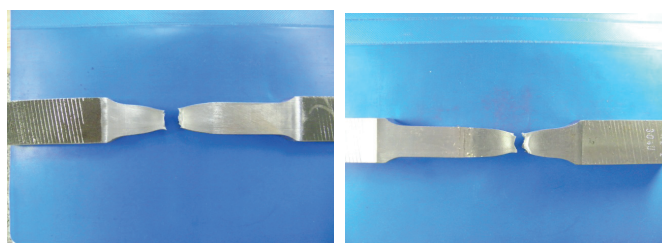

Fig. 7. A way of taking and preparing samples for tension [23]

Pictures of the samples after transverse tensile are presented in the picture 8.



TT2 – 1 – Plate 1 – 136 TT2 – 1 – Plate 2 - 111



TT2 – 2 – Plate 1 – 136 TT2 – 2 – Plate 2 - 111

Fig. 8. Pictures of the samples after transverse tensile

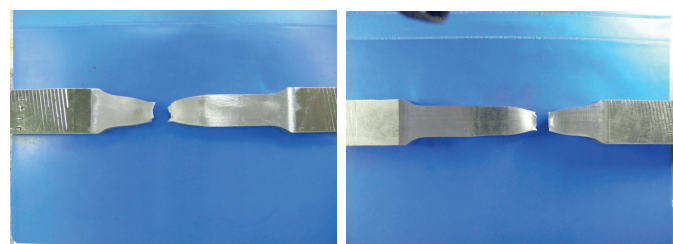

TT1 – 1 – Plate 1 – 136 TT1 – 1 – Plate 2 - 111

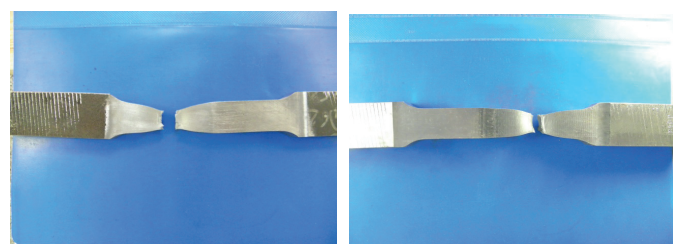

TT1 – 2 – Plate 1 – 136 TT1 – 2 – Plate 2 - 111

9. Weld metal tensile test

Weld metal tensile test was done according to the PN-EN ISO 876 standard in order to measure tensile strength of the same weld. A way of preparing a sample presents picture 9 [13].

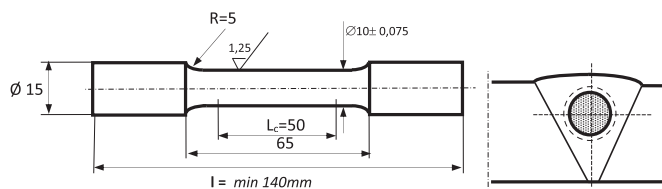

Fig. 9. A way of taking and preparing a sample to stretch the weld metal. [26]

TABLE 10

Weld metal tensile tests' results

| Sample | Re, MPa | Rm, MPa | Elongation, % | Result of the examination |
|----------------------|---------|---------|---------------|---------------------------|
| LT1-1- Plate 1 - 136 | 384 | 513 | 27.8 | Positive |
| LT1-1- Plate 2 - 111 | 416 | 675 | 44.4 | Positive |

Pictures of the samples after tensile testing of the weld metal are presented in the picture 10.

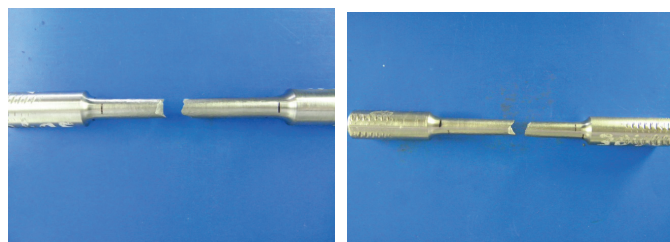

LT – 1 – Plate 1 – 136

LT – 1 – Plate 2 – 111

Fig. 10 Pictures of the samples after tension of the weld metal

Except of measuring tensile strength of the weld, there was also a measurement of elongation A5, and the

limit of plasticity. An examination was taken in the room temperature. Following criteria were taken into account: $R_e \geq 315\text{MPa}$, $A \geq 21\%$, $R_m \geq 470\text{MPa}$ (table 10) [26]. Higher resistance and plasticity values were obtained in case of the plate no. 2, which is the result of using nickel based electrodes.

10. Impact strength test

Due to the mixed connection, except of a standard three-set samples taken from the weld and three from heat-affected zones, an additional set was used from the heat-affected zone of the second material. Recommendations from PN-EN ISO 9016 and PN-EN ISO 148-1 standards were used. Pictures 11 and 12 depict a way of taking each set. An examination was

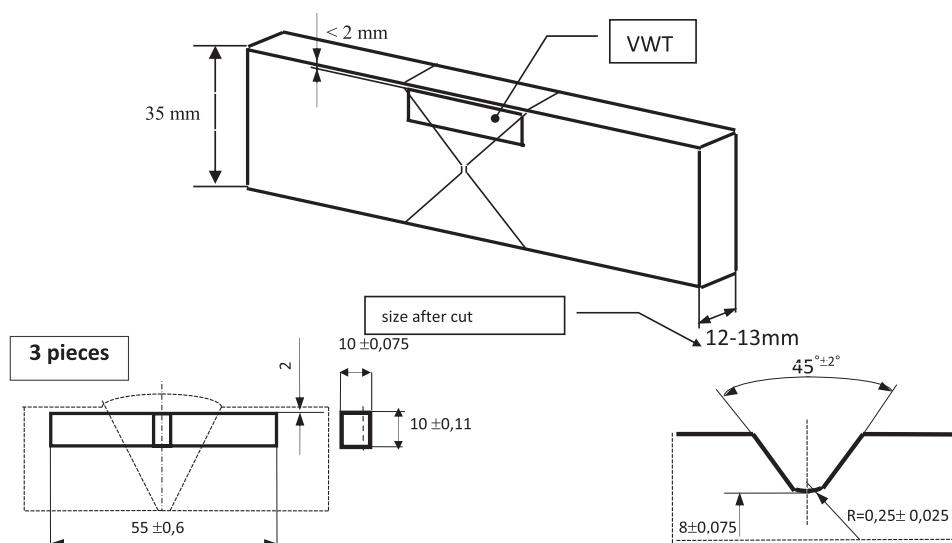

Fig. 11. A way of preparing samples taken from the weld to the impact strength tests [14]

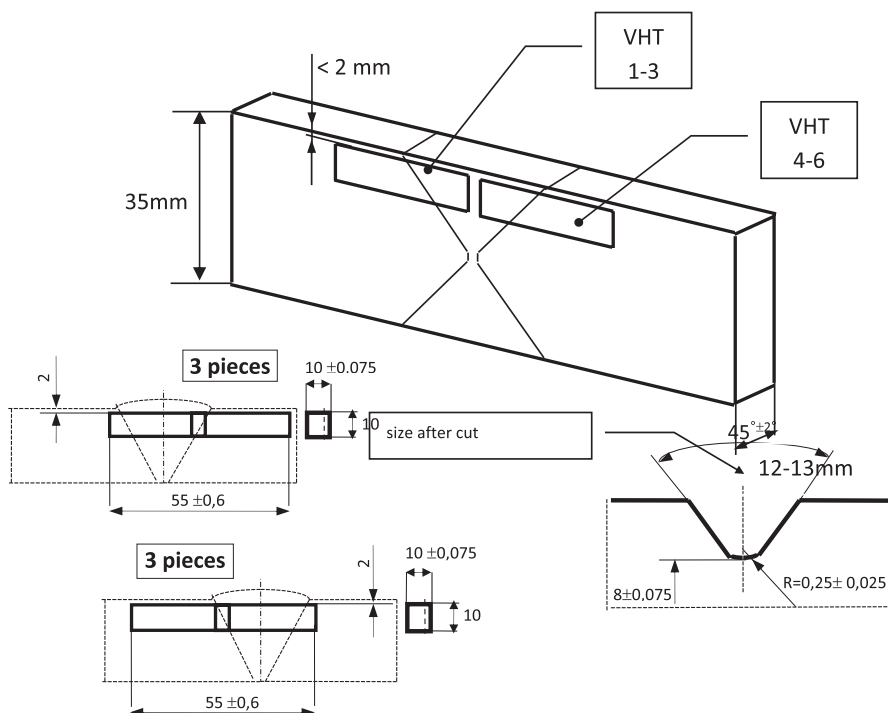

Fig. 12. A way of preparing samples taken from the heat-affected zones to the impact strength tests [14]

TABLE 11

Results of the impact strength tests

| Plate | Sample | 1, J | 2, J | 3, J | Average, J |
|---------|--------------------------|------|------|------|------------|
| 1 – 136 | VWT1/2 – P355NL1 | 88 | 26 | 26 | 47 |
| | VHT1/2 – weld | 14 | 5 | 6 | 8 |
| | VHT1/2 - X2CrNiMoN22-5-3 | 33 | 36 | 18 | 29 |
| 2 – 111 | VWT1/2 – P355NL1 | 140 | 130 | 138 | 136 |
| | VHT1/2 – weld | 128 | 128 | 133 | 130 |
| | VHT1/2 - X2CrNiMoN22-5-3 | 75 | 110 | 59 | 81 |

taken in -40°C temperature on the Charpy's hammer of 30 kg = 300 J weight [24, 25]

Pictures of the samples after an impact strength test are presented in the picture 13.

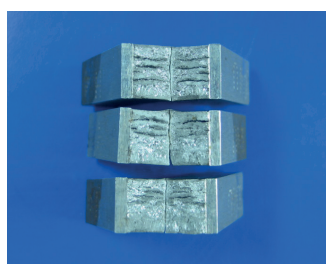

VHT1/2 P355NL1 – Plate 1 – 136

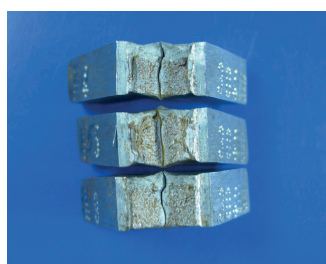

VHT1/2 P355NL1 – Plate 2 - 111

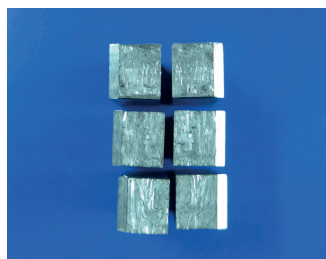

VWT0/2 weld – Plate 1 - 136

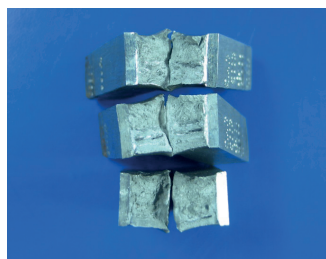

VWT0/2 weld – Plate 2 - 111



VHT1/2 X2CrNiMoN22-5-3 – Plate 1 – 136

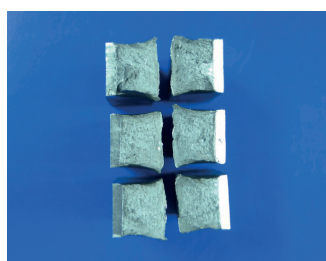

VHT1/2 X2CrNiMoN22-5-3 – Plate 2 - 111

Fig. 13. Pictures of samples after an impact strength test

Impact strength tests have finished negatively in case of the plate no. 1. A required value of breaking operation equals to 27 J was not obtained both for P355N11 material, and also 40 J for the duplex steel (table 11). It is caused by an increase of embrittlement activated by the carbon diffusion from the carbon steel into the weld during a thermal treatment, and an occurrence of the brittle sigma phase.

In case of using nickel based filler material (plate no. 2) much higher breaking operation values were obtained. Elements included in the chemical composition of used

electrodes mostly nickel, niobium and titanium, which are stabilizers, stopped carbon diffusion. Moreover, they caused appearance of carbides, which increase embrittlement and decrease resistance of the material to corrosion. Pictures prove that samples taken from the nickel welded joint (plate no. 2) broke in a plastic way, while the fracture of samples from the plate no. 1 is evidently brittle.

11. Macroscopic examination

Macroscopic examination was taken according to PN-EN 1321 standard on a previously taken and etched metallographic specimen (fig. 14). Adler's solution was used to etch. [20]

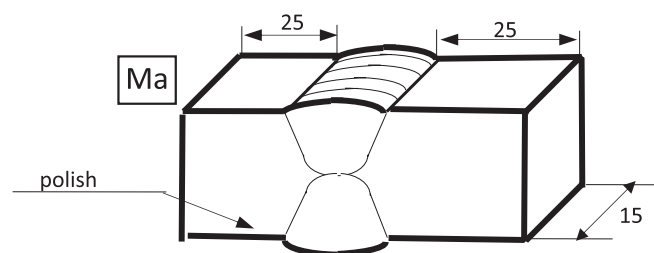

Fig. 14. A way of preparing a metallographic specimen [10]

Macroscopic pictures of plates are presented in the picture 15.

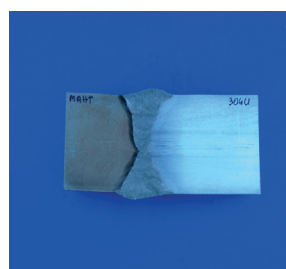

Plate no. 1

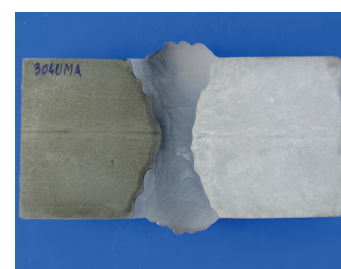

Plate no. 2

Fig. 15. Macroscopic pictures of plates

Macroscopic examination did not reveal any of unaccepted discrepancies in the section of examined plates (fig. 15)

12. Microscopic examination

Microscopic images were taken on the metallographic specimen etched by the agent consisting of nital and Mi20Fe (fig. 16). Zoom 200:1 was used. An examination was taken according to the PN-EN 1321 standard [20]

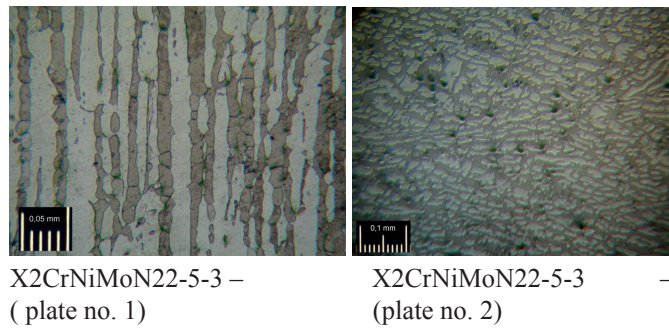
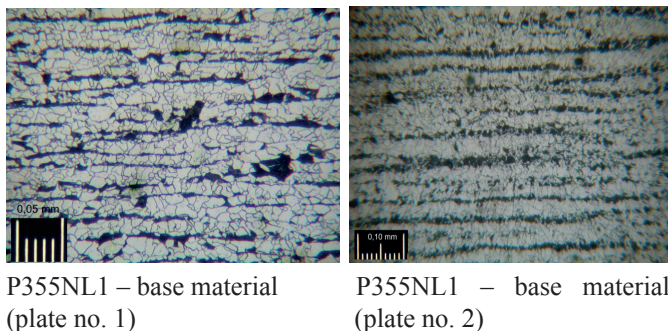
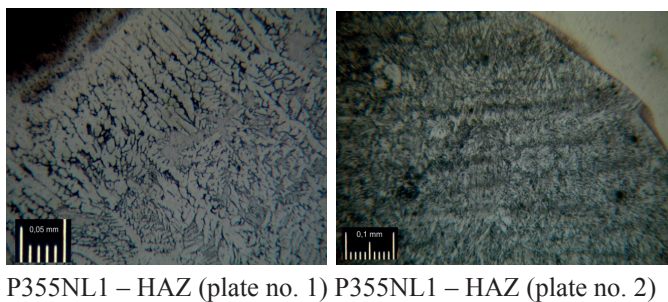
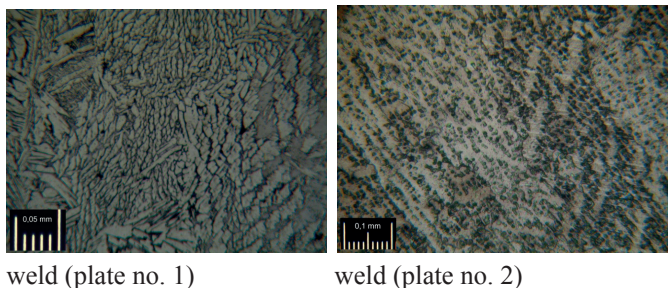

Fig. 16. Microscopic pictures of plates



A structure of a heat-affected zone on the side of the duplex steel in case of the plate no. 1 includes about 40-50% ferrite. The weld indicates a ferrite-austenite structure with a required share of ferrite i.e. 30-70%

Microscopic examination in case of the plate no. 2 does not reveal any microcracks or other discrepancies. It was stated that the base material on the side of the carbon steel has a ferrite-pearlite structure, and on the side of the duplex steel has a ferrite-austenite structure with a ferrite content of about 45%. The weld is characterised by the ferrite-austenite structure of grown austenite grains with a ferrite content not exceeding a value of 85% near the weld line (fig. 16).



13. Hardness test

Hardness test by the Vickers method was done on the metallographic specimen, previously used in the macroscopic examination. Hardness test was done according to the PN-EN ISO 9015-1 standard along specified measurement lines (fig. 17). Vickers testing device was used 430 SVD with the load of HV10 [19].

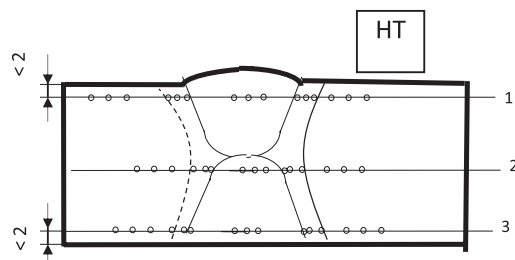
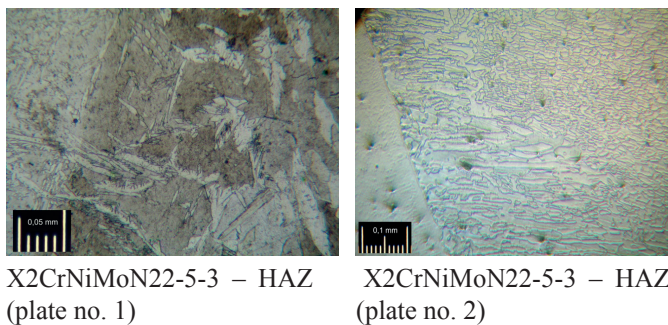

Fig. 17. A way of doing a hardness test [19]

TABLE 12

Results of hardness tests of the plate 1 – method 136

| nr | 1 | 2 | 3 | 4 | 5 | 6 | 7 | 8 | 9 | 10 | 11 | 12 | 13 | 14 | 15 |
|----|-----|-----|-----|-----|-----|-----|-----|-----|-----|-----|-----|-----|-----|-----|-----|
| 1 | 158 | 151 | 160 | 173 | 193 | 219 | 276 | 290 | 290 | 266 | 258 | 258 | 251 | 245 | 243 |
| 2 | 150 | 146 | 146 | 202 | 212 | 206 | 272 | 262 | 304 | 279 | 279 | 279 | 243 | 245 | 240 |
| 3 | 139 | 138 | 140 | 177 | 199 | 206 | 274 | 281 | 287 | 276 | 276 | 274 | 240 | 233 | 242 |

TABLE 13

Results of hardness tests of the plate 2 – method 111

| Nr | 1 | 2 | 3 | 4 | 5 | 6 | 7 | 8 | 9 | 10 | 11 | 12 | 13 | 14 | 15 |
|----|-----|-----|-----|-----|-----|-----|-----|-----|-----|-----|-----|-----|-----|-----|-----|
| 1 | 149 | 153 | 151 | 202 | 224 | 249 | 187 | 172 | 177 | 258 | 240 | 237 | 227 | 235 | 228 |
| 2 | 150 | 149 | 153 | 183 | 186 | 201 | 197 | 209 | 199 | 279 | 266 | 260 | 227 | 230 | 228 |
| 3 | 149 | 149 | 146 | 183 | 202 | 235 | 191 | 193 | 173 | 251 | 225 | 233 | 233 | 238 | 235 |

Results of the hardness tests are depicted in the picture 18

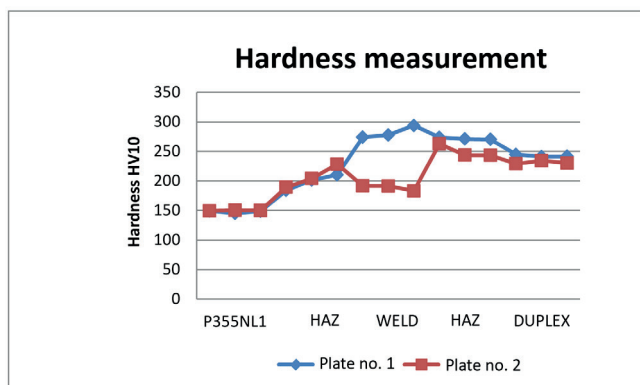

Fig. 18. Results of the hardness measurement

In case of the plate no. 1, the lowest hardness was stated inside the P355NL1 metal sheet, its value is much higher in the duplex steel, and definitely the highest in the weld (table 12, 13). Hardness of both base materials plate no. 2 is very close to the measurement of the plate no. 1, whereas in case of the weld much lower hardness was observed in the joint made by the nickel based electrodes. It is caused by the high plastic properties of mentioned electrodes.

It is vital to point that according to the PN-EN ISO 15614-1 standard hardness test is not done for the materials from the group 10 including duplex steel. In case of above sample plates an examination was taken only to do an experiment [15].

14. Examining a content of delta ferrite

Examining a content of delta ferrite was taken according to the PN-EN ISO 8249 standard by the Fischer MP 30E-S Feritscope (fig. 19) on the previously used for an examination a metallographic specimen. Measurements refer an area of the weld, the duplex steel, and the black steel [21].

In case of both sample plates a content of delta ferrite in the structural steel ranges from 96 to 100%. There was a considerable decrease of ferrite share (plate no. 1) in the duplex steel from the joint welded by the flux-cored wire in

comparison to plate no. 2. The weld made by the duplex wire is characterized by the dual microstructure. A device cannot measure a content of delta ferrite in the nickel weld due to insufficient sensitivity of the feritscope. Thus, it can be stated that a share of delta ferrite does not exceed 0,1%.



Fig. 19. The Fisher MP 30E-S Feritscope

15. Summary and conclusions

A part of examinations taken on the samples from the plate no. 1 (welded by the flux-cored wire) has finished negatively. Impact strength tests showed too low breaking operation, while examining a content of ferrite, and the macroscopic examinations revealed a lack of a required share of the α structure in the weld. It is a result of an appearance the brittle sigma phase connected with the carbon diffusion caused by the thermal treatment of the weld.

All the examinations taken on the plate no. 2 have finished positively. Despite a thermal treatment after welding there was not any increase of embrittlement. The weld metal based on nickel, and the foremost stabilizing elements, which are included in the content of electrodes, kept carbon diffusion,

TABLE 14

Results of examining a content of delta ferrite – plate 1 – method 136

| No. | Zone | 1, % | 2, % | 3, % | 4, % | 5, % | Average % |
|-----|-----------------|------|------|------|------|------|-----------|
| 1 | Weld | 43.0 | 39.0 | 48.0 | 50.0 | 40.0 | 44.00 |
| 2 | X2CrNiMoN22-5-3 | 26.0 | 33.0 | 32.0 | 26.0 | 27.0 | 28.80 |
| 3 | P355NL1 | 95.0 | 96.0 | 99.0 | 95.0 | 97.0 | 96.40 |

TABLE 15

Results of examining a content of delta ferrite – plate 2 – method 111

| No. | Zone | 1. % | 2. % | 3. % | 4. % | 5. % | Average % | |
|-----|-----------------|---|-------|------|------|------|-----------|--|
| 1 | Weld | Out of range of the device (sensitivity 0.1%) | | | | | | |
| 2 | X2CrNiMoN22-5-3 | 45.0 | 44.8 | 45.6 | 45.6 | 44.3 | 45.06 | |
| 3 | P355NL1 | 98.9 | 100.0 | 99.2 | 98.3 | 97.7 | 98.80 | |

and therefore the joint obtained high plastic and resistance properties.

Welding different types of joints of the duplex steel with a low-alloyed steel does not make any troubles. Difficulties appear during a thermal treatment. A proper solution is a use of materials based on nickel, and particularly a precise choice of parameters, which do not allow to overheat the joint.

REFERENCES.

- [1] J. Nowacki, *Stal dupleks i jej spawalność*, Warszawa 2009.
- [2] A. Lisiecki, *Welding of titanium alloy by Disk laser*. Proc. of SPIE **8703**, Laser Technology 2012: Applications of Lasers, 87030T (January 22, 2013), DOI: 10.1117/12.2013431.
- [3] T. Węgrzyn, J. Mirosławski, A. Silva, D. Pinto, M. Miros, Oxide inclusions in steel welds of car body, *Materials Science Forum* **636-637**, 2010.
- [4] A. Lisiecki, *Diode laser welding of high yield steel*. Proc. of SPIE **8703**, Laser Technology 2012: Applications of Lasers, 87030S (January 22, 2013), DOI: 10.1117/12.2013429.
- [5] T. Węgrzyn, *Mathematical Equations of the Influence of Molybdenum and Nitrogen in Welds*. Conference of International Society of Offshore and Polar Engineers ISOPE'2002, Kita Kyushu, Japan 2002, Copyright by International Society of Offshore and Polar Engineers **4**, ISBN 1-880653-58-3, Cupertino – California – USA 2002.
- [6] T. Węgrzyn, *The Classification of Metal Weld Deposits in Terms of the Amount of Oxygen*, Proceedings of the Conference of International Society of Offshore and Polar Engineers ISOPE'99, Brest, France 1999, International Society of Offshore and Polar Engineers **4**, 212-216, Cupertino – California, USA 1999.
- [7] T. Węgrzyn, J. Piwnik, D. Hadrys, *Oxygen in steel WMD after welding with micro-jet cooling*, *Archives of Metallurgy and Materials* **58**, **4**, 1067-1070 (2013).
- [8] Ł. Konieczny, R. Burdzik, T. Figlus, *The possibility to control and adjust the suspensions of vehicles*, J. Mikulski (Ed.): *Activities of Transport Telematics*, pp. 378-383, TST 2013, CCIS 395.
- [9] T. Węgrzyn, J. Piwnik, J. Łazarz, D. Hadrys, *Main micro-jet cooling gases for steel welding*, *Archives of Metallurgy and Materials* **58**, **2**, 556-559 (2013).
- [10] R. Burdzik, *Identification of structure and directional distribution of vibration transferred to car-body from road roughness*, submitted to *Journal of Vibroengineering* **16**(1), 324-333 (2014).
- [11] K. Lukaszewicz, A. Kriz, J. Sondor, *Structure and adhesion of thin coatings deposited by PVD technology on the X6CrNiMoTi17-12-2 and X40 CrMoV5-1 steel substrates*, *Archives of Materials Science and Engineering* **51** 40-47 (2011).
- [12] Metrode – katalog produktów.
- [13] Böhler – katalog produktów.
- [14] Atesty blach.
- [15] PN-EN ISO 15614-1:2008 – *Specyfikacja i kwalifikowanie technologii spawania metali – Badanie technologii spawania – Część 1: Spawanie łukowe i gazowe stali oraz spawanie łukowe niklu i stopów niklu*.
- [16] PN-EN ISO 15609-1:2007 – *Specyfikacja i kwalifikowanie technologii spawania metali – Instrukcja technologiczna spawania – Część 1: Spawanie łukowe*.
- [17] PN-EN ISO 17633:2010 – *Materiały dodatkowe do spawania – Druty elektrodowe proszkowe i pręty do spawania łukowego w osłonie gazu i bez osłony gazu elektrodą metalową stali nierdzewnych i żaroodpornych – Klasyfikacja*.
- [18] PN-EN ISO 5173:2010 – *Badania niszczące spoin w materiałach metalowych – Badanie na zginanie*.
- [19] PN-EN ISO 9015-1:2011 – *Badania niszczące złączy spawanych metali – Badanie twardości – Część 1: Badanie twardości złączy spawanych łukowo*.
- [20] PN-EN 1321:2000 – *Spawalnictwo – Badania niszczące metalowych złączy spawanych – Badania makroskopowe i mikroskopowe złączy spawanych*.
- [21] PN-EN ISO 8249:2005 – *Spawanie – Określanie liczby ferrytu (FN) w stopiwnie nierdzewnych chromowo-niklowych stali austenitycznych i ferrytyczno-austenitycznych dupleks*.
- [22] PN-EN 13445-4:2009 – *Nieogrzewane płomieniem zbiorniki ciśnieniowe – Część 4: Wytwarzanie*.
- [23] PN-EN ISO 4136:2011 – *Badania niszczące złączy spawanych metali – Próba rozciągania próbek poprzecznych*.
- [24] PN-EN ISO 9016:2011 – *Badania niszczące złączy spawanych metali – Badanie udarności – Usytuowanie próbek, kierunek karbu i badanie*.
- [25] PN-EN ISO 148-1:2010 – *Metale – Próba udarności sposobem Charpy'ego – Część 1: Metoda badania*.
- [26] PN-EN 876:1999 – *Spawalnictwo – Badania niszczące spawanych złączy metali – Próba rozciągania próbek wzdłużnych ze spoin złączy spawanych*.
- [27] www.e-spawalnik.pl.