

## Selected issues related to heat storage tank modelling and optimisation aimed at forecasting its operation

KRZYSZTOF BADYDA<sup>a</sup>  
WOJCIECH BUJALSKI<sup>a\*</sup>  
GRZEGORZ NIEWIŃSKI<sup>a</sup>  
MICHAŁ WARCHOŁ<sup>b</sup>

<sup>a</sup> Institute of Heat Engineering, Warsaw University of Technology, ul. Nowowiejska 21/25, 00-665 Warszawa, Poland

<sup>b</sup> Institute of Control and Computation Engineering, Warsaw University of Technology

**Abstract** The paper presents results of research focused on modelling heat storage tank operation used for forecasting purposes. It presents selected issues related to mathematical modelling of heat storage tanks and related equipment and discusses solution process of the optimisation task. Presented detailed results were obtained during real-life industrial implementation of the optimisation process at the Siekierki combined heat and power (CHP) plant in Warsaw owned by Vattenfall Heat Poland S.A. (currently by Polish Oil & Gas Company – PGNiG SA) carried out by the Academic Research Centre of Power Industry and Environment Protection, Warsaw University of Technology in collaboration with Transition Technologies S.A. company.

**Keywords:** Optimisation; Heat accumulator; Heat storage tank; Mathematical modelling; CHP

## 1 Introduction

Cogeneration is one of the cheapest ways to generate electricity nowadays. Combined heat and power generation are promoted by the European Union.

---

\*Corresponding author. E-mail address: [bujalski@itc.pw.edu.pl](mailto:bujalski@itc.pw.edu.pl)

In Europe in general there are multiple district heating systems powered by combined heat and power (CHP) plants with back pressure turbines. The main disadvantage of cogeneration is that the electricity production is driven by heat production (i.e. demand). The load curve of the heating system varies depending on the time of day, day of the week, and season. In daily scale the largest heat demand is observed at night and smallest during the day.

Simultaneously the electricity demand is lowest at night and highest during days with two standard peaks: in the mornings and afternoon. Accordingly the electricity gets most expensive at that time. Therefore it is beneficial to maximize electricity generation during morning and afternoon peaks, and minimize it during the decreased demand at night.

Electrical and heat outputs at a CHP plant can be uncoupled by using a heat accumulator. The heat storage principle in power plants and district heating systems has been known and used since the very beginning of the district heating. The first heat storage tanks (steam accumulators) were used at the times when steam reciprocating engines were commonly operated. The tanks were used to store the exhaust steam from those engines. It could later be utilized for heating. Currently the district heating systems use both short-term and long-term heat storages, the latter mostly in solar power applications. The short-term heat storage tanks have been used for many years (decades) in individual house heating systems. Recently the heat storage tanks have been also gaining popularity in district heating systems. The interest with such devices started to considerably rise approximately 30 years ago together with the development of small local CHP plants. Nowadays the tanks are also constructed for large and very large plants.

This study proposes a mathematical model to describe a large CHP plant with a heat storage tank to be used for operational optimization [2]. Potential increases in profits from electricity sales enabled by the heat accumulator were also evaluated.

## 2 Description of the modelled system

The Siekierki CHP plant – the largest such facility in Poland and second largest in Europe – is the most important heat source of the district heating (DH) system of Warsaw, which is the largest DH network in the European Union [1]. The plant operates nine steam turbine-generator units: two of

them of extraction-condensing type (52 and 125 MW), three large 100 MW class back pressure units, three 30 MW extraction-back pressure units and one more 30 MW turbine without a controlled extraction (operating as back pressure the turbine). Five smallest turbines are installed within the older part of the plant and are supplied from a common steam header fed by four steam boilers. Remaining four turbines are installed within the newer part of the plant and operate in power unit system with assigned boilers. This CHP system is complemented by six hot water boilers. Thus the configuration of heat sources at the plant is quite complex. The heat storage tank is meant to cooperate with the power unit (newer) part of the plant in the first place (Fig. 1). Its main technical parameters are presented in the Tab. 1.

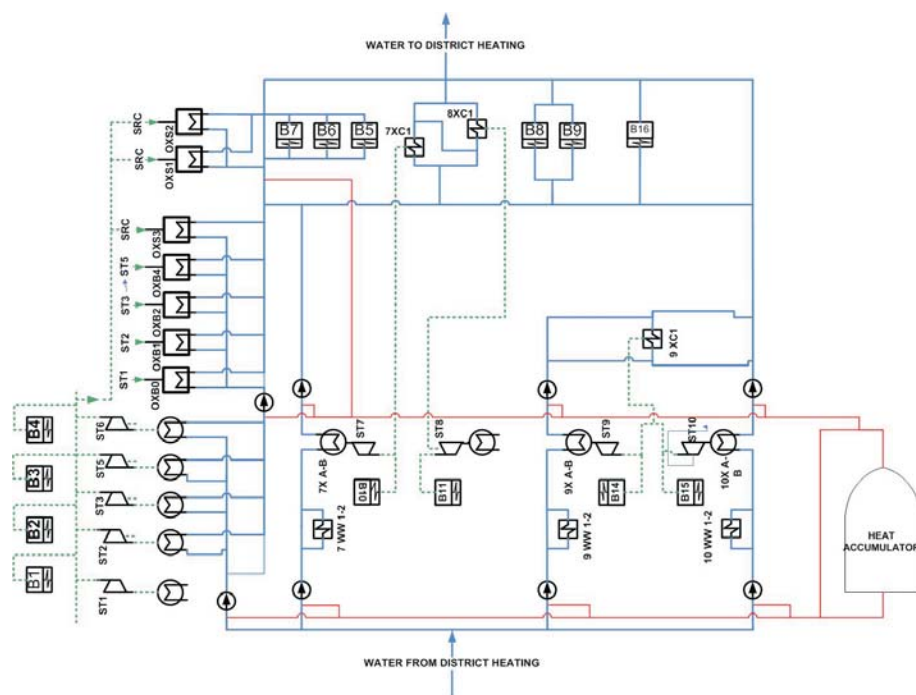

Figure 1. Simplified diagram of the heat sources at the Siekierki CHP plant, showing interconnection with the heat storage tank (main symbols: K – boiler, ST – turboset).

The main target of the heat storage tank construction set at the investment preparatory stage was improving flexibility of operated turbine-generator units, mainly in order to enable increased power output during the

peak demand periods. Achieving that target is more complicated than in case of large heat storage tanks installed at Western-European CHP plants for a number of reasons:

- large heat storage tanks in Western CHP plants mostly cooperate with large extraction-condensing turbines. There are practically no large back pressure turbines – such as the ones at Siekierki – in operation in Western-European systems
- ratio between the installed thermal output and storage capacity is considerably different than in other cases. Siekierki plant has a complex process structure and simultaneously very high heat output
- typical load variation in Warsaw’s climate conditions is different than in most Danish or even German/Austrian cities. The climate in Warsaw is relatively harsh due to geographical location (e.g. long distance from the coast, when compared to Denmark).

Table 1. Key parameters of the heat storage tank installed at Siekierki CHP Plant

No.	Parameter	Unit	Value
1	Tank volume	m <sup>3</sup>	30400
2	Tank height	m	47
3	Tank diameter	m	30
4	Heat capacity	MWh	1600
5	Heating power output	MW	300
6	Insulation thickness	mm	500
7	Charging/discharging rate	Mg/h	4500

### 3 Equipment models

In order to model heat storage tank operation it is necessary also to model operation of the other plant equipment. Due to limitations in the volume of the presented study only some selected components of the plant will be discussed: proposed models of an extraction-condensing and extraction-back pressure turbines.

A mathematical model of an extraction-condensing turbine is a combination of separate models of a back pressure turbine (without heating

steam extraction) and a condensing turbine. Figure 2 presents a simplified diagram of a modelling concept for the steam turbine ST-1.

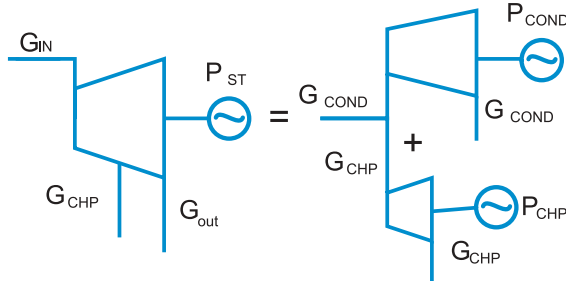

Figure 2. Combination concept for modelling extraction-condensing turbine.

Electric output of an extraction-condensing turbine-generator unit is thus a sum of outputs generated by an equivalent system composed of:

- back pressure turbine – with the steam flow as observed between the steam admission into the turbine and the extraction of real life turbine'
- condensing turbine – with the steam flow as remaining after the extraction.

Relation describing power generation at the turbine-generator unit is therefore:

$$P_{CHPST1}^i = a_{ST1} Q_{EXCH0XB0}^i + b_{ST1}, \quad (1)$$

$$P_{ST1}^i = P_{CHP}^i + P_{CONDST1}^i, \quad (2)$$

$$P_{CONDST1MIN} \leq P_{CONDST1}^i, \quad (3)$$

$$Q_{EXCH0XB0MAX} \geq Q_{EXCH0XB0}^i, \quad (4)$$

where:

- $a_{ST1}, b_{ST1}$  – turbine characteristic coefficients for the ST-1 unit,
- $Q_{EXCH0XB0}^i$  – thermal output of the 0XB0 heat exchanger (see Fig. 1),
- $P_{CHPST1}^i$  – electrical output of the cogeneration process,
- $P_{CONDST1}^i$  – electrical output of the condensing process,
- $i$  – time step number.

Figure 3 presents an exemplary operational area of an extraction-condensing turbine. Presented values are applicable to the ST-1 turbine at Siekierki CHP plant. The operational area (permissible heat and electricity load) for a turbine is restricted by lines:

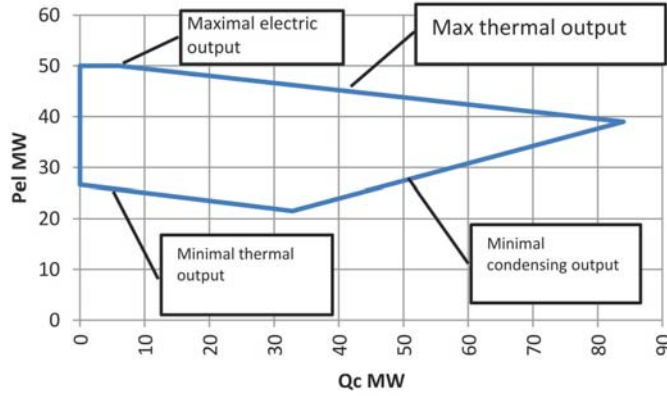

Figure 3. Exemplary characteristics of an extraction-condensing turbine-generator unit.

- from the top – maximum electrical output of 50 MW and a line determining ratio between electrical and heating outputs at maximum live steam flow into the turbine (maximum heat flow into the turbine is  $E_{ST1MAX}^i=147\text{MW}$ ),
- from the right – restriction caused by the maximum thermal power of the heat exchanger OXB0 (see Fig. 1) fed with steam from the controlled extraction,
- from the bottom – straight line describing minimum power output in the condensing mode and another straight line determined by the electrical/heating power ratio at minimum live steam flow into the turbine ( $E_{ST1MIN}^i=76\text{MW}$ ).

At assumed heat generation value at the exchanger  $Q_{EXCH0XB0}$  the electrical power output of the ST-1 will be therefore variable.

Power supplied to the extraction-condensing turbine in live steam is given by equation:

$$E_{ST1}^i = \frac{P_{CHPST1}^i}{\eta_{mST1}\eta_{gST1}} + \frac{Q_{EXCH0XB0}^i}{\eta_{eST1}} + \frac{P_{CONDST1}^i}{\eta_{cST1}}, \quad (5)$$

$$E_{ST1MIN} \leq E_{ST1}^i \leq E_{ST1MAX}, \quad (6)$$

where:

- $\eta_{mST1} = 0.97$ ,  $\eta_{gST1} = 0.98$  – mechanical turbine efficiency and generator efficiency,  
 $\eta_{eST1} = 0.98$  – heat exchange efficiency of the heat exchanger,  
 $\eta_{cST1} = 0.35$  – efficiency of converting steam energy into electricity in purely condensing operation.

Mathematical model for the extraction-back pressure turbine is a combination of two models of back pressure turbines without controlled steam extractions. Figure 4 presents a simplified diagram of a modelling concept for the extraction-back pressure turbine.

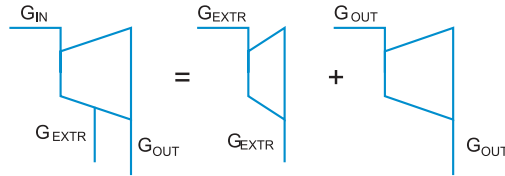

Figure 4. Combination concept for modelling extraction-back pressure turbine.

Electric output of the extraction-back pressure turbine-generator unit is thus a sum of outputs generated by an equivalent system composed of:

- back pressure turbine – with the steam flow as observed between the steam admission into the turbine and the extraction of real life turbine
- back pressure turbine – with the steam flow as remaining after the extraction.

Relation describing power generation at the turbine-generator unit is therefore:

$$P_{ST2}^i = P_{ST2-1}^i + P_{ST2-2}^i = a_{ST2} Q_{EXTRST2}^i + b_{ST2} Q_{OUTST2}^i + c_{ST2} , \quad (7)$$

$$Q_{OUTST2MIN} \leq Q_{OUTST2}^i \leq Q_{OUTST2MAX} , \quad (8)$$

$$0 \leq Q_{EXTRST2}^i \leq Q_{EXTRST2MAX} , \quad (9)$$

where:

- $a_{ST2}, b_{ST2}$  – turbine characteristic coefficients for the ST-2 unit,
- $c_{ST2}$  – turbine characteristic coefficient for the ST-2 unit,
- $a_{ST2-1}, b_{ST2-1}$  – coefficients of equation restricting output of the OXB1 heat exchanger,
- $Q_{EXTRST2}^i$  – thermal output from extraction to the OXB1 heat exchanger,
- $Q_{EXTRST2MAX}$  – maximum thermal output of the OXB1 heat exchanger,
- $Q_{OUTST2}^i$  – thermal output of the condensing heat exchanger ST-2,
- $P_{ST2-1,2}^i$  – electric power in cogeneration process.

Figure 5 presents an example operational area of one back-pressure turbine.

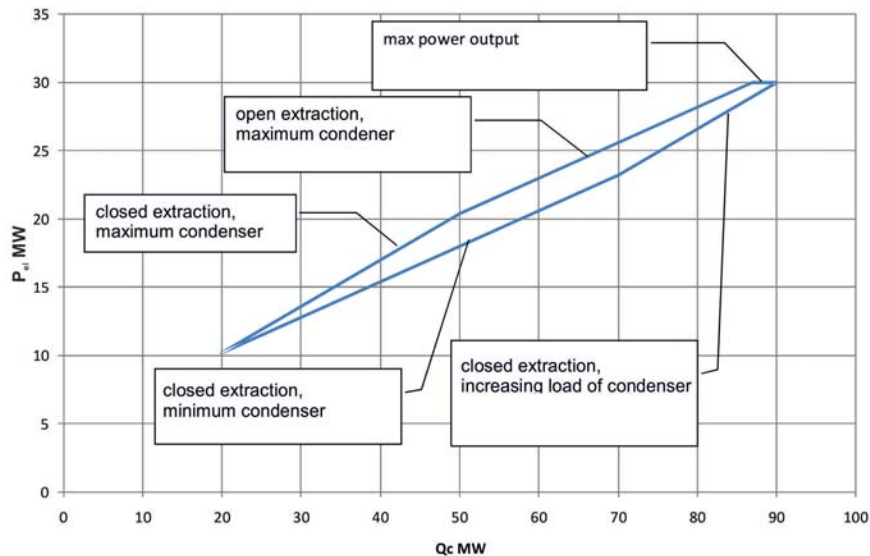

Figure 5. Exemplary characteristic of the extraction-back pressure turbine-generator unit.

The operational area (permissible heat and electricity load) for a turbine is restricted by lines:



- from the top – the line determining a ratio between electric power and heat generation at closed extraction, line for the maximum condenser heating load and gradually opening extraction into the OXB heat exchanger (see Fig. 1), and maximum electric output of the generator,
- from the bottom – the line describing turbine operation at minimum heating output and gradually opening extraction supplying steam into the OXB heat exchanger, characteristic line for the maximum load at OXB heat exchanger (extraction fully open), and gradually increasing load in the ST condenser,
- therefore at assumed heat output  $Q$  the electric power of the extraction-back pressure turbine is variable.

Power supplied to the extraction-back pressure turbine in live steam is given by the equation:

$$E_{ST2}^i = \frac{P_{ST2}^i}{\eta_{mST2}\eta_{gTZ2}} + \frac{Q_{ST2}^i}{\eta_{wST2}} \quad (10)$$

where:

$$Q_{ST2}^i = Q_{EXTRST2}^i + Q_{OUTST2}^i, \quad (11)$$

- $Q_{ST2}^i$  – heating output of the ST-2 turbine-generator unit,
- $\eta_{mST2} = 0.97, \eta_{gST2} = 0.98$  – turbine mechanical efficiency and generator efficiency, respectively,
- $\eta_{wST2} = 0.98$  – heat exchange efficiency of the heat exchanger.

In order to optimise operation of the system equipped with the heat storage tank [3], it is necessary to prepare operational plan for the tank [4]. It is impossible to optimise operation just for the present moment. To do so it is necessary to know the system load and energy prices in the future, i.e. for at least one day in advance. The authors assume that only the heat storage tanks for balancing the load in frames of several hours are discussed.

In order to model operation of a system it is necessary to construct a complete mathematical model, i.e. model of the tank and cooperating plant. The storage tank model for heat load predictions in real systems has to be composed of two elements [4]. One is condition of the tank at the calculation start. The other is charging/discharging process model. This study discusses a water displacement tank which accumulates heat in

the form of hot water. A drawing of such a tank is presented in Fig. 6. Heat is delivered to the accumulator by pumping hot water into it from the top, while the cold water is simultaneously recovered from the bottom. Discharging is carried out by a reverse process.

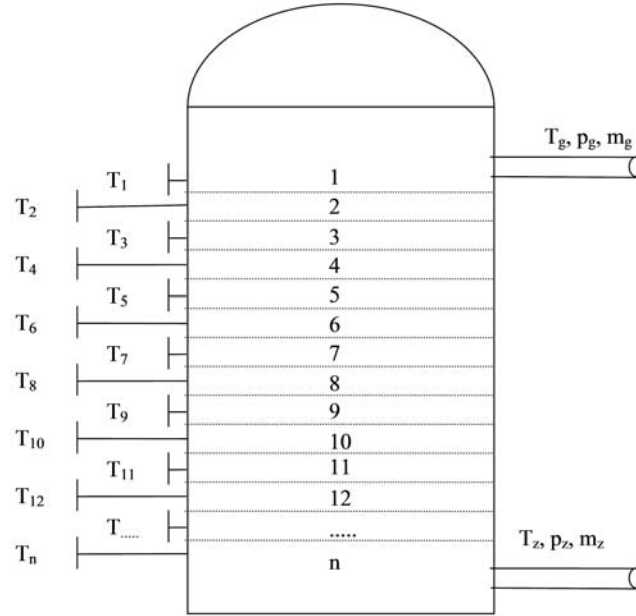

Figure 6. Heat storage tank model.

In order to determine the amount of stored heat the accumulator's model was divided into areas. Those areas are marked in figure with numbers from 1 to  $n$ . Number of areas depends on spacing between temperature measurement points. The model assumes that the temperature within each area is constant. Therefore amount of stored heat is determined as:

$$Q_{accu}^0 = \sum_n \frac{\pi d^2}{4} l_n \rho_w c_w (T_n^0 - T_z^0), \quad (12)$$

where:

- $d$  – tank inner diameter,
- $l_n$  – height of the  $n$ -th area,
- $c_w$  – specific heat of water as function of temperature and pressure,

- $\rho_w$  – water density equal to 970 kg/m<sup>3</sup>,
- $T_n$  – water temperature in area  $n$  at moment „0”,
- $T_z$  – cold water temperature – temperature of water in the return line at the moment for which the capacity is calculated,
- $n$  – consecutive numbers of areas within the tank, except for the bottom one.

This equation shows that the amount of heat stored in the tank will change with the temperature of return water from the connected district heating system. In some cases it can turn out that negative heat is stored in the lower part of the accumulator.

Using hot water from the tank makes sense only when its temperature is considerably higher than that of the return water from the district heating (DH) system. Therefore the model assumes finding location of the so-called hot zone. This location is determined by checking the following conditions for individual areas of the tank, starting from the top:

$$t_n^0 > t_z^0 + \Delta t_{hot} , \quad (13)$$

where:

- $t_n$  – temperature in the area  $n$  at the moment „0”,
- $t_z$  – cold water temperature – temperature of return DH water at the moment for which the capacity is calculated,
- $\Delta t_{hot}$  – required difference between the hot water temperature and return DH water temperature.

Therefore the accumulated heat is added up (according to the Eq. (12)) from the area no. 1 to the area no.  $n_g$ , where  $n_g$  is a number of the last (lowest) hot area. Because it is assumed in the model that there are no heat losses to the environment the amount of accumulated heat does not physically change when the tank is not charged or discharged. Nevertheless the amount of heat available for supporting operation of the system will vary according to changes in the return DH water temperature. For the same reason also the location of the hot zone determined by the relation (12) will be changing as well.

The full heat accumulation model should reflect movement of individual water areas within the tank. In a general case there are multiple layers of water with different temperatures. The assumed measurement method as shown in Fig. 6 does not provide full information about the temperature profile along the height of the tank. Only temperatures in a number of selected points are known. In order to determine the amount of heat accumulated in

the tank it was assumed that the water temperature within individual areas is constant. For the sake of forecasting it can be assumed that distribution of layers (distribution of temperature along the height) does not matter, however the temperature of water pumped in/out is significant however for operations and controlling the system. From the model's point of view accepting the medium water temperature for operational forecasting will result with incorrectly calculated maximum power output from the tank. The design of water displacement tanks restricts the flow of water pumped in and out because exceeding some threshold velocities would result with mixing hot and cold water inside the tank. Therefore the maximum thermal output delivered by the tank depends on the hot water temperature in individual areas of the tank (the power input depends on the temperature of cold water in the tank). The model of the tank describing changes of accumulated heat for the predicted area was used in a simplified form, in which the average power input and output was calculated according to average temperatures in hot and cold zones:

$$\dot{Q}_{in}^{\max} = \dot{m}_{\max} \left( i_{av}^{hot} - i_{re} \right) , \quad (14)$$

where:

- $\dot{Q}_{in}^{\max}$  – maximum heat collection (discharge) rate,
- $\dot{m}_{\max}$  – maximum water flow in/out,
- $i_{av}^{hot}$  – specific average hot water enthalpy,
- $i_{re}$  – specific return DH water temperature.

During further computational steps the amount of accumulated heat can be determined in a following way:

$$Q_{accu}^{i+1} = Q_{accu}^i + \dot{Q}_{in}^i t \quad (15)$$

where:

- $Q_{accu}^{i+1}$  – heat accumulated in the tank at the moment  $i + 1$ ,
- $Q_{accu}^i$  – heat accumulated in the tank at the moment  $i$ ,
- $\dot{Q}_{in}^i$  – heat transfer rate from the selected (cooperating) generation system,
- $t$  – time step.

Therefore the following relation will be true:

$$\dot{Q}_{in}^i < \dot{Q}_{in}^{\max} , \quad (16)$$

where:

- $\dot{Q}_{in}^i$  – thermal input power from the selected (cooperating) generation system at the moment  $i$ ,  
 $\dot{Q}_{in}^{\max}$  – maximum heat collection (discharge) rate.

In order to carry out the optimisation [5] it is necessary to define the target function [6]. For this purpose it was assumed that the discussed plant is obliged to cover the heat demand, and that it also sales electricity. The electricity is contracted – output is declared 24 h in advance. Operational profit [78] during the discussed period can be presented as:

$$\begin{aligned}
 PROFIT_o = & \sum_i K_{El}^i + \Delta K_{HA} - \sum_i K_{Emis}^i + \\
 & - \sum_i K_{Fuel}^i - \sum_j K_{start-up}^j + \\
 & - \sum_k K_{shut-down}^k - \sum_i K_{fine}^i,
 \end{aligned} \tag{17}$$

where:

- $i$  – computational step index,
- $j$  – index of devices started up,
- $k$  – index of devices shut down,
- $K_{El}^i$  – income from electricity sales in consecutive computational steps,
- $K_{Emis}^i$  – emission cost,
- $K_{fuel}^i$  – fuel cost for individual computational steps,
- $K_{start-up}^j$  – start-up cost of individual devices,
- $K_{shut-down}^k$  – shut-down cost of individual devices,
- $\Delta K_{HA}$  – cost resulting from the difference of heat accumulated in the tank at the beginning and end of the discussed time frame and its sales cost,
- $K_{fine}^i$  – fine (loss) resulting from disobeying the submitted electricity sales schedule.

The most difficult element of forecasting operations of the heat storage tank is the device start-up and shut-down management. Nevertheless it is a necessary element of forecasting the operations with a heat storage capability. The heat accumulator can affect the set of devices (units) operating at a given moment. It can allow to cover some small excessive loads. Therefore using the heat storage tank can reduce start-up and shut-down costs.

### 3.1 “Global” restrictions

Except for operational restrictions applicable for individual pieces of equipment, there is also a number of “global” restrictions for entire the CHP plant, which cannot be directly assigned to any device. These restrictions are:

- restrictions of the water flow entering/leaving the tank,
- power restrictions for the condensers’ cooling water pumps,
- restrictions preventing heat transfer between certain devices and the heat storage tank.

Let us use the following notation:  $Q_p$  – generated heat,  $Q_{pz}$  – heat generated in equipment cooperating with the heat storage tank,  $Q_{po}$  – heat generated in equipment not cooperating with the heat storage tank,  $Q_o$  – heat delivered to the DH network,  $Q_z$  – heat delivered to the heat storage tank (negative value stands for heat consumption from the tank).

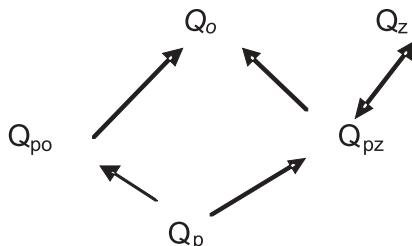

Figure 7. Graph presenting distribution of the generated heat.

Figure 7 presents distribution of the heat generated in all sources. Additional restrictions result from direction of arrows and resulting positive values of heat flows. Direction of  $Q_p \rightarrow Q_{po}$  and  $Q_p \rightarrow Q_{pz}$  lines results from methods of calculating  $Q_{po}$  and  $Q_{pz}$  - if for each of those devices generated heat is split into two non-negative components, also the sums of those components will never be negative. Also direction of the  $Q_{po} \rightarrow Q_o$  line results from the heat transfer direction  $Q_p \rightarrow Q_{po}$  and does not require introduction of a new restriction. Care only needs to be taken when investigating  $Q_{pz} \rightarrow Q_o$  line, and therefore a new restriction needs to be added:

$$Q_{pz} - Q_z \geq 0 . \quad (18)$$

Because at the same time

$$Q_z = Q_p - Q_o , \quad (19)$$

we may state that:

$$Q_p - Q_{pz} \leq Q_o . \quad (20)$$

Heat transferred along the line  $Q_{pz} \rightarrow Q_o$  may not be negative, but is also limited from the other side by the pumps capacity.

$$Q_{pz} - Q_z \leq Q_{pumps} \Rightarrow Q_o - Q_{pumps} \leq Q_p - Q_{pz} . \quad (21)$$

Restriction  $Q_{pz} - Q_z \leq Q_{pumps}$  is important during discharging the heat storage tank (as the heat from the tank is transferred along the line  $Q_{pz} \rightarrow Q_o$ ). When charging the tank it is important to observe the maximum flow limitation for the line  $Q_p \rightarrow Q_{pz}$

$$Q_{pz} \leq Q_{pumps} . \quad (22)$$

After adding limitation for the flow into/out of the tank:

$$-Q_{zrmax} \leq Q_z \leq Q_{z^3max} \Rightarrow Q_o - Q_{zrmax} \leq Q_p \leq Q_o + Q_{z^3max} \quad (23)$$

we get a full set of “global” restrictions.

$$\left\{ \begin{array}{l} Q_o - Q_{pumps} \leq Q_p - Q_{pz} \leq Q_o \\ Q_{pz} \leq Q_{pumps} \\ Q_o - Q_{zrmax} \leq Q_p \leq Q_o + Q_{z^3max} \end{array} \right. . \quad (24)$$

## 4 Solution of the optimisation task

Solution of the optimisation task is very complex. Various algorithms may be used for this purpose. One of possibilities is using genetic algorithms [9], however the authors of this study have proposed their own algorithm.

The full computational process for operational optimisation of a heat storage tank must include determining loads for individual devices (sources) in the entire system (including those which do not directly cooperate with the tank, but have an impact on load of those which do).

The process of optimisation of operating devices in most cases needs carrying out calculations for all possible combinations. The number of possible configurations is usually significantly restricted. The configuration has to provide required minimal and maximal output and enable start up of individual devices. Therefore it is possible to discuss all acceptable combinations of operating devices for a given load condition.

In case of calculations carried out in order to forecast the heat storage tank operation the discussed time frame should be at least 24 h. In many cases it is necessary actually to discuss a longer period, for instance of 7 days. The point is to address the specificity of different load curves for different days of a week, primarily during weekends. The operational optimisation of the tank requires considering of all possible load conditions at the same time, because the charging level depends on the load in individual considered states.

A typical computational step for this type of calculations is one hour. In some special cases also shorter steps can be considered, for instance 15 min. With the entire time frame between 1 and 7 days it is necessary to calculate from 24 to 672 load conditions at a time. For an average CHP plant the number of decisive variables (i.e. those which are the subject of optimisation) for a single load condition were from ca. 10 to 50 or even more. At such conditions the number of such variables for the entire task (together for all load conditions) is between 240 and 33600. It is obvious therefore that the magnitude of the computational task significantly depends on the assumptions. Time of calculations is also greatly dependent on the number of decisive variables taken into account in a single computational cycle. Solving the optimisation case for a large number of variables and numerous time steps can be really laborious.

If the optimisation task also includes the full selection of operating devices combination, it is necessary to repeat the calculations for several such combinations. The devices can be started up in various time steps. Therefore the case grows significantly. In order to simplify and shorten the computational process an alternate solution was proposed for further discussion.

The optimization algorithm with a hierarchic structure is proposed as follows:

- On the top level the status of devices is selected (work, start-up, stopping). It is done by the heuristics described in Section 5. In order to assess the quality of its own decisions, the heuristics calls the load distribution optimization procedure that is conducted by the middle and bottom layers.
- On the middle level the heat flow to the accumulator for each hour is selected.
- On the bottom level the work of all the devices in every hour is optimized. Due to the possibility of changing the load on each of the



devices on hourly basis, the only variable connecting the optimal load on each of them at every hour is the accumulator's condition. Fully independent tasks are obtained for each hour basing on the specified by the middle layer heat flow to the heat accumulator.

#### 4.1 Extended operational area

The extended operational area has been defined for the devices with non-continuous operational range. This area contains both normal operational area of the device and its stopping point (zero point). The area is defined in such a way, that minimal and maximal values are zero or correspond to the maximum value. Therefore during an "extended" operation the device cannot exceed maximum values or display zero values.

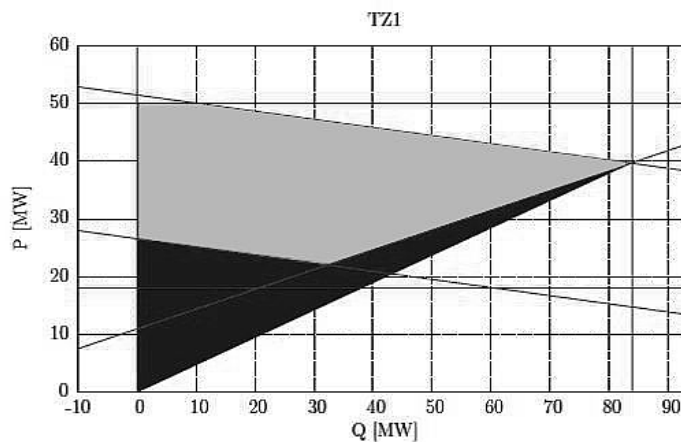

Figure 8. Operational area for the ST-1 turbine,  $Q$  – heat transferred to water,  $P$  – electric power output.

Figure 8 shows the extended operational area concept on example of a selected turbine-generator unit. Grey area marks the area permissible during the normal operation. Dark grey is the extended operation area.

#### 4.2 Determining outputs of individual devices

The bottom layer determines operating parameters of individual pieces of equipment at designated hour and at specified values of heat power delivered to the storage tank  $Q_{oz}$  and to the DH network  $Q_o$ . Also the status of devices determined by the upper layer is known.

During optimisation process the CHP plant is represented by the graph. Each node represents one piece of equipment and each line represents the steam flow. The graph is not 1-connected – it can be split into the common steam header part, power units and water boilers. There is no steam exchange between those parts. Following elements are assigned to each node  $i$  of the graph:

- Decision variables describing condition of the given device  $X_i$ . In order to reduce size of the task it has been assumed that device condition is determined by its decision variables, as well as steam demands of all devices supplied with steam by the given device.
- Connections to the devices consuming steam delivered by the given device. Those connections allow inquiring steam consumers about their demand. Those needs are linear functions of consumers' decision variables (directly or indirectly)
- Set of restrictions for decision variables. All restrictions are linear. Although restrictions are only related to operation of the given device, they can also contain decision variables of steam consumers, through steam demand functions which affect the device.
- Electrical power output of the device  $P_i$ . It is a linear function of decision variables of the device in question and decision variables of steam consumers.
- Thermal power output supplied to DH water by the device  $Qo_i$ . Thermal power is also a linear function of decision variables of the device in question, as well as decision variables of steam consumers.
- Thermal power output supplied to DH water which may be used for charging the heat storage tank  $Qoz_i$ . It is a part of the total thermal power output supplied to DH water. Heat delivered to DH water in some equipment (e.g. hot water boilers) may not be stored in the storage tank.
- Cost of fuel consumed by the device  $cf_i$ . If the device consumes fuel, the fuel demand is calculated as a linear function of decision variables. If no fuel combustion occurs in the device (e.g. for turbines), the fuel cost is 0.
- Cost of additional certificates  $cc_i$ . This element represents additional cost other than fuel cost. Costs of CO<sub>2</sub> or SO<sub>2</sub> emissions may be added to the fuel cost and are not taken into account in this element.

This value allows setting additional preference for some equipment, other than fuel-related costs (e.g. “punishment” factors for equipment spoiling the company’s image). At current version the non-zero certificate costs are assigned to electricity generated in the condensing mode.

- Connections to devices supplying steam to the specified piece of equipment. In most cases there is only one such connection (if it exists at all). The exception is the common steam header which is also represented by a graph node. The main task of the header node is distribution of the total steam demand (reported by the consumers connected to the header) between the steam generators. Steam demand reported to steam generators connected to the header are decision variables of the header, while restrictions are:
  - positive demand values (inequality limitation),
  - sum of all header demands must be equal to sum of all demands of steam consumers supplied from the header (equation limitation).

In order to determine optimal operational parameters of all pieces of equipment, following quality indicator is minimised:

$$Jd = -PROFIT_o, \quad (25)$$

where:  $PROFIT_o$  – operating profit (Eq. (17)).

### 4.3 Determining heat flow into the storage tank

The middle layer determines heat flow into/from the heat storage tank in individual hourly periods. Essentially the task solved by this layer is a sequence of bottom layer tasks for individual hours with several additional restrictions. Minimised quality indicator is:

$$Jm = \sum_{t \in H} Jd_t, \quad (26)$$

where  $H$  is set of time moments for which optimisation is carried out (horizon) and  $Jd_t$  is a quality indicator from the bottom layer for the hour  $t$ . Minimisation is carried out with regard to bottom layer decision variables for consecutive hours and heat transfer to the tank for consecutive hours. Restrictions for this task are:

- bottom layer restrictions for individual hours,
- heat flow to/from tank restriction:

$$-Qz_{max} \leq Qz_t \leq Qz_{max} , \quad (27)$$

- restrictions for the heat storage tank condition:

$$0 \leq Qz^0 + \sum_{\substack{i \in H \\ i \leq t}} \leq Qz^{max} . \quad (28)$$

This task, while linear, is quite a large one. For this reason it has been decomposed. The middle layer does not solve the full task, but utilises also the bottom layer. Direct coordination method is used – coordinator variables are heat flows into the tank for individual hours. Those variables separate local tasks for disjoint tasks assigned to hourly periods. If the function determining minimal value of the bottom layer quality indicator according to the heat flow into the tank is designated as  $JL_t(Qz)$ , then:

$$Jm = \sum_{t \in H} JL_t(Qz) . \quad (29)$$

Therefore the coordinator will minimise  $Jm$  in reference to  $Qz_t$  with restrictions:

$$-Qz_{max} \leq Qz_t \leq Qz_{max} , \quad (30)$$

$$0 \leq Qz^0 + \sum_{\substack{i \in H \\ i \leq t}} \leq Qz^{max} . \quad (31)$$

The coordination task is also linear because the function  $JL_t(Qz)$  is convex and piecewise linear. However the record of coordination task is linear the task form will be quite long and will require introduction of auxiliary decision variables representing vertices of  $JL_t(Qz)$  function. Therefore instead of real  $JL_t(Qz)$  functions the coordinator uses their simplified models  $\tilde{JL}_t(Qz)$ . The simplified model is also a piecewise linear function, but it has no more than three linear sections. The coordinator updates its local task models so they match the real local task function at the current point.

Coordinator's algorithm is as follows:

1. Assume some model for  $JL_t(Qz)$  function from local tasks.
2. Solve the coordination task using current models and obtaining coordinator's decision variable values – heat flows to the heat storage tank in individual hours.

3. Solve next local tasks for previously obtained heat flows to the heat storage tank. Check target function values obtained from local tasks and – if they are different than obtained from the model – update model at this point,
4. If any model was changed, go to point 2.

The algorithm presented above stops when all local task models comply with reality and simultaneously the current point is a solution for optimisation task carried out with simplified models. Because both  $\sum_{\Sigma} t \in HJL_t(Qz)$  and  $\sum_{\Sigma} t \in H\tilde{J}L_t(Qz)$  functions are convex, the issue whether the point is optimal is determined by its neighbourhood. Therefore if the function model matches the real function at the solution point for the simplified task, the same point is also the solution for the full task.

#### 4.4 Determining equipment conditions

The task of the top layer is determining optimal device conditions. This layer uses a heuristic approach, which aims at minimising quality indicator value but does not guarantee achieving this target.

The minimised quality indicator may be split into two elements: cost attributable to the current equipment operation at specified condition and costs attributable to start-ups and shut-downs. The initial point for the algorithm is the optimal solution, which does not take into account start-up and shut-down costs. From there it attempts to minimise number of start-ups and shut-downs, thus improving the second part of the quality indicator.

An important part of the algorithm is verification of technical possibility to use the proposed operational equipment configuration. This process might use the optimisation algorithm of the middle layer, however:

- if the configuration is possible there is no need to wait for completing calculations,
- it is possible to check technical possibility faster than by calculating the initial optimisation point.

Faster method for verifying configuration technical possibility is provided by a tunnelling algorithm described below.

#### 4.5 Tunnelling algorithm

Finding the tunnel of allowed heat storage tank conditions is an iterative process carried out for consecutive time frames. In each iteration the range of allowed states is determined by maximal  $Q_{\max}^i$  and minimal  $Q_{\min}^i$  charge in the tank at the moment  $i$ , and appropriate values for the next moment  $Q_{\max}^{i+1}$  and  $Q_{\min}^{i+1}$  are calculated. In order to find those values it is necessary to know:

- maximal and minimal possible heating output
- maximal amount of heat which can be sent to/from the accumulator.

Maximal  $Q_{\max}^i$  and minimal  $Q_{\min}^i$  amount of heat which can be generated and can be calculated by solving a local case. For the moments in which the electrical output is determined (by scheduling) the local cases impose additional restriction on electrical output. Except for that the local cases are identical as those for the moments when the electricity output is not given.

The maximum rate at which it is possible to transfer the heat into the tank is designated as  $\dot{Q}_{\max\_inHA}^i$ , while maximum rate of transferring the heat out of the accumulator is  $\dot{Q}_{\max\_outHA}^i$ . If at a given moment the heat load (demand)  $\dot{Q}_o^i$  fits in the range  $(\dot{Q}_{\min\_p}^i, \dot{Q}_{\max\_p}^i)$  we can transfer heat into the tank or collect it from there. So it is possible either to increase the  $Q_{\max}^i$  or decrease the  $Q_{\min}^i$ :

$$Q_{\max}^{i+1} = Q_{\max}^i + \min \left( \dot{Q}_{\max\_inHA}^i, \dot{Q}_{\max\_outHA}^i, -\dot{Q}_o^i \right) \Delta t, \quad (32)$$

$$Q_{\min}^{i+1} = Q_{\min}^i + \min \left( \dot{Q}_{\min\_inHA}^i, -\dot{Q}_{\min\_outHA}^i, \dot{Q}_o^i \right) \Delta t. \quad (33)$$

If  $\dot{Q}_o^i > \dot{Q}_{\max\_p}^i$  then in order to keep the predicted heat supply it is necessary to discharge the accumulator. Nevertheless there is a still a question of the rate at which it will be discharged. The formula for  $Q_{\max}^{i+1}$  changes into:

$$Q_{\max}^{i+1} = Q_{\max}^i - \left( \dot{Q}_o^i - \dot{Q}_{\max\_p}^i \right) \Delta t. \quad (34)$$

There is no  $\dot{Q}_{\max\_outHA}^i$  in the formula above, though it does not make this parameter totally insignificant – when  $\dot{Q}_o^i - \dot{Q}_{\max\_p}^i > \dot{Q}_{\max\_outHA}^i$  then the heat load cannot be covered by the discussed configuration. If  $\dot{Q}_o^i < \dot{Q}_{\min\_p}^i$  then even at a smallest heat output there is surplus heat and

it has to be accumulated in the tank. Then the formula for  $Q_{\min}^{i+1}$  changes into:

$$Q_{\min}^{i+1} = Q_{\min}^i + (\dot{Q}_{\min\_p}^i - \dot{Q}_o^i) \Delta t. \quad (35)$$

If  $\dot{Q}_{\min\_p}^i - \dot{Q}_o^i > \dot{Q}_{\max\_inHA}^i$  then there is no more heat accumulation capacity at the discussed configuration. The above equations do not have restrictions on the amount of heat accumulated in the tank. This however does not mean that any amount can be actually stored there. If the tank is full of water at a maximum temperature, the temperature difference between incoming and outgoing flows is 0, so the charging rate also falls down to zero, and no more heat can be accumulated. Similarly during discharging the tank a moment comes when the temperature of the topmost layer is equal to the DH system return water temperature and discharging rate drops to zero.

The tunnel of allowed trajectories for the amount of heat in the tank generated according to this model includes also states which could be achieved without exceeding the limits earlier, but which would inevitably lead to exceeding the restrictions later on regardless of the process control of the tank operation. It is possible to filter such solutions out. To do so it is necessary to carry out identical algorithm in reverse, starting from the latest moment. In this way we get a tunnel of conditions which might be impossible to carry out, but which do not lead to exceeding restrictions later. The ultimate tunnel is a common part of both generated tunnels – calculated from the beginning and from the end. If some tunnel narrows to the value lower than zero or when a common part of both tunnels is at some point of time empty then it is impossible to keep within the limits at a given configuration. Depending on which restrictions are active at the moment when tunnel closes, it is possible to determine whether there is too much or not enough heat in the tank and in which direction the configuration should be modified. If the tunnel closes it means that it is not possible to cover the demand, so it is necessary to start up additional devices. The tunnel does not solve the issue of shutting down devices in case when a number of sources is running at minimal output. From the system's point of view such a solution is inefficient. In order to solve that problem it is necessary to construct the tunnel many times. Thanks to the multiple tunnel construction process it is possible to indicate necessary start-ups and shut-downs by modelling.

## 4.6 Heuristic algorithm

The algorithm for finding optimal configuration of operating devices consists of allowing extended conditions for all pieces of equipment and then launching load sharing optimisation (middle layer). Then a decision is made for each device whether it should be operational or shut down at the specified moment, basing on operational parameters specified during optimisation stage. Further on the periods of operation and standby are combined to achieve longer times of operation and the process is repeated for the next device.

1. Allow extended condition for all switchable equipment.
2. Set all devices as “operational” except for cases where operator has openly specified other condition.
3. Optimise equipment parameters (middle layer).
4. For each consecutive device:
  - (a) lock the extended condition,
  - (b) select times of operation and standby for each device basing on current operating parameters,
  - (c) connect neighbouring operation times and standby times into operational and standby periods,
  - (d) delete standby periods shorter than the start-up time,
  - (e) add equipment start-up times,
  - (f) find the shortest standby or operating period,
  - (g) if the shortest period is shorter than the minimal feasible operating time then try to delete that period (check if the configuration after deleting it is permissible, if it is not – then the deletion fails) and go back to the previous section,
  - (h) repeat optimisation of equipment parameters.

The algorithm description presented above is quite cursory and requires more detailed discussion. The optimisation is only carried out if the device status has changed. Otherwise the “operating” or “standby” status is only approved. If the operating parameters are within the extended area, the change into both “operating” and “standby” is seen as a change.



The algorithm has a number of protection measures for situations when it is unable to carry out optimisation or when the tunnel unexpectedly closes. The optimisation may fail for the first time at the point 3. In such a case heat demand is adjusted to appropriate values. The tunnel may close at any condition change, not necessarily at point 4g. If it closes at a point 4b, then other conditions of the device are specified. If it closes at point 4d or 4e, also heat demands are modified to values which may be achieved.

Also point 4b requires more discussion. In order to determine whether the given device should be operating or shut down at certain hour, values of parameters determining operating point for that device are investigated. Because the last optimisation is carried out with extended operating condition allowed, three situations are possible:

1. Device parameters correspond to the stopped (standby) condition.
2. Device parameters correspond to normal operation.
3. Device parameters correspond to extended condition.

The first two cases are obvious – they mean that the device should be either started up or shut down at the investigated time. Selection of device condition in the third case depends on the previous course of optimisation and status in neighbouring hours. The status assumed by the algorithm is ruled by the following rules (word “sequence” here denotes a number of consecutive hours with the same class of device parameters – “standby”, “normal operation” or “extended operation”).

1. If at any time during previous optimisation the heat demand has dropped and did not ever increase, then assume that device is operating.
2. If at any time during previous optimisation the heat demand has increased and simultaneously has never been reduced, then assume that device is stopped.
3. If it is the first sequence of the prediction period, then:
  - (a) if it is the last sequence of the prediction period, assume that device is stopped,
  - (b) if it is followed by a standby sequence, assume that device operates,

- (c) if it is followed by an operating sequence, assume that device is stopped.
4. If there is an operation sequence before:
- (a) if it is the last sequence of the prediction period, assume that device is stopped,
  - (b) if it is followed by a standby sequence, assume that device is stopped,
  - (c) if it is followed by an operation sequence, assume that device is stopped.
5. If there is an outage (standby) sequence before:
- (a) if it is the last sequence of the prediction period, assume that device is operating,
  - (b) if it is followed by a standby sequence, assume that device is operating,
  - (c) if it is followed by an operation sequence, assume that device is stopped.

Assumed statuses have the same class for entire sequence of consecutive conditions. Hence the neighbours can only sequences “operates” or “standby”, there also might be neighbour, but in no case there may be a neighbour “extended operation”.

## 5 Results

Currently the advisory system for heat storage tank scheduling is used at Siekierki CHP plant owned by Vattenfall Heat Poland S.A. as a production system. It has met a number of requirements submitted by the contracting entity. Optimisation process is fast enough to provide results in a ten or so minutes. Exemplary results are shown in the figures below. Figure 9 presents heat storage tank operation, i.e. variability of charging rate against the background of heat demand and electricity prices, while Fig. 10 presents corresponding loads on generation equipment.

Precision of the proposed heuristic algorithms is sufficient to determine

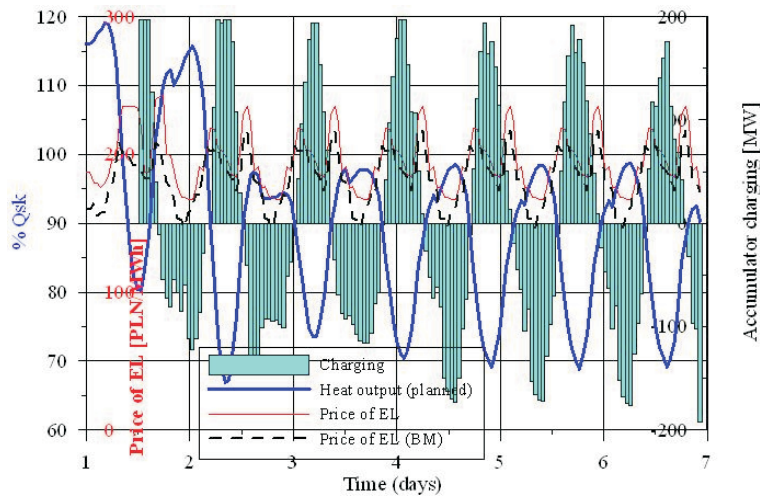

Figure 9. Result of optimisation carried out by the advisory system for 7 days' time.

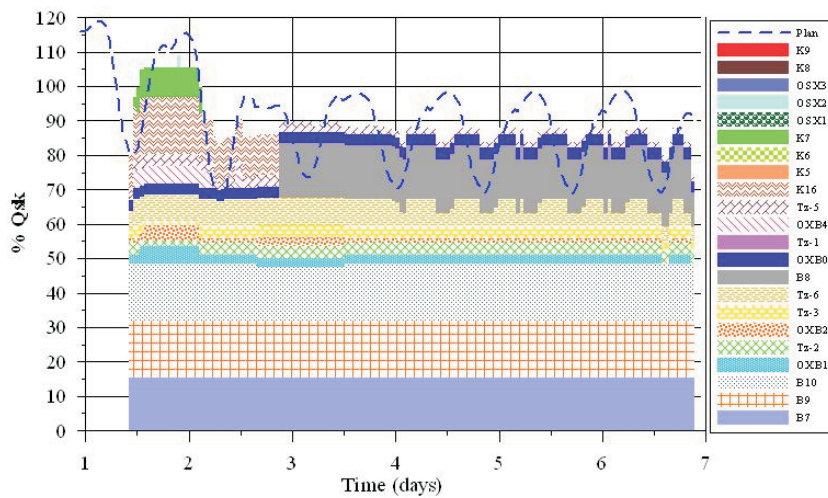

Figure 10. Result of optimisation carried out by the advisory system for 7 days' time-load dispatch between heat sources, operation with the heat storage tank. Legend as in Fig. 6.

the moments of equipment start-ups and shut-downs even during transitional periods – an example can be seen in Figs. 9 and 10. During transition periods heat output is still relatively high, but changes quickly and therefore equipment selection process is very difficult.

## 6 Conclusions

The study presented selected issues related to heat storage tank modelling. Modelling of the tank itself is mathematically easy however constructing a model collaborating with digital control systems requires solving various problems. Requirements for accuracy of the mathematical model of individual pieces of equipment are relatively low at this case as the modelling is based on forecasts which are not very accurate themselves. This allows to use simple models, which are relatively easy to solve. On the other hand solution of entire optimisation task is multi-layered and very complex. Solution of the full optimisation task with selecting operating equipment configuration and taking into account start-up times is not possible within minutes – as required. Therefore the authors have proposed algorithms which simplify the case – application of so-called extended operating areas, equipment selection heuristic and a tunnelling algorithm. This approach allows to quickly and efficiently solve the optimisation case.

*Received 10 October 2011*

## References

- [1] BUJALSKI W., BADYDA K., NIEWIŃSKI G.: *Optimisation system of the heat storage tank for Vattenfall Heat Poland S.A. Technical design of the system – calculation algorithms*. ITC PW, September 2009 (not published, in Polish)
- [2] BADYDA K., BUJALSKI W.: *Heat accumulator operation modelling for load forecasting*. Rynek Energii **6**(85), 2009, 61–67 (in Polish).
- [3] BOGDANA Z., KOPJAR D.: *Improvement of the cogeneration plant economy by using heat accumulator*. Energy **31**(2006).
- [4] BADYDA K., BUJALSKI W., ŚWIRSKI K., MILEWSKI J., LEWANDOWSKI J.: *Numerical Research and Optimization of Application of the Heat Storage Tank in District Heating Network*. Research project number N513 3589 37. Report, ITC PW, Warsaw, October 2010 (in Polish).
- [5] BUJALSKI W., LEWANDOWSKI J., UZUNOW N.: *On-line optimisation of the load distribution in power generating installation*. In: Proceedings of the International Conference on Power Engineering-03 (ICOPE-03), 9–13 November 2003, Kobe, Japan.
- [6] KOTOWICZ J., BARTELA Ł.: *The influence of economic parameters on the optimal values of the design variables of a combined cycle plant*. Energy **35**(2010), 911–919.
- [7] BADYDA K., BUJALSKI W.: *CHP analysis in free market conditions*. Zeszyty Naukowe Politechniki Warszawskiej, ser. Konferencje **24**(2005) (in Polish).

- 
- [8] THORSTENSEN B.: *Combined heat-and-power plants and district heating in a deregulated electricity market*. Applied Energy **78**(2004), 37–52 .
- [9] KOTOWICZ J., BARTELA Ł.: *The thermodynamic and economic optimisation of a gas-steam power plant by means of genetic algorithms*. Rynek Energii **2**(75), 2008, 31–38 (in Polish).