

RYSZARD BARTNIK^{1*}
ZBIGNIEW BURYŃ²
ANNA DUCZKOWSKA-KĄDZIEL³

¹ Opole University of Technology
Faculty of Mechanical Engineering

² PGE GiEK SA, Branch Opole Power Plant

³ Opole University of Technology
Faculty of Production Engineering and Logistics

Influence of structure of heat recovery steam generator and of gas turbogenerator power repowering a 370 MW unit on the power plant operating in cogeneration cycle

The paper presents results of technical calculations involving the selection of a structure of heat recovery steam generator and of gas turbogenerator power applied for adaptation of a coal-fired power unit with the rated capacity of 370 MW to dual-fuel steam-gas system. Calculations were conducted for a unit operating under cogeneration cycle.

1 Introduction

The most effective way of reducing the consumption of chemical energy of the fuels and emission of harmful products during fuel combustion into the environment is the cogeneration, i.e., concurrent production of heat and electricity. The adaptation of a power unit to cogeneration mode will result in the improvement of the total energy efficiency of its operation [3]. Moreover, its simultaneous super structuring to cogeneration mode will increase this effectiveness to a bigger extent. Modernization of a power unit by repowering it with a gas turbogenerator and heat recovery steam generator also leads to the improvement of its economic effectiveness. Mainly, this is dependent on the relations of prices between energy

*Corresponding Author. E-mail: r.bartnik@po.opole.pl

carriers, i.e., on price relations of between heat and electricity and fuel prices, coal and gas as well as on the overall capacity of the system, i.e. amount of electricity and heat production in the unit and thereby, on the capacity of a gas turbogenerator and the structure of a heat recovery steam generator used to super structure the power plant.

The paper [1] presents a thermodynamic analysis of the condensing mode of a 370 MW power unit repowered by a gas turbogenerator and a heat recovery steam generator. In this its operation in cogeneration mode is analyzed (Fig. 1). Differences between the optimal thermodynamic capacity of the gas turbine for the condensing mode and cogeneration are presented with regard to a 370 MW power unit and relative to the number of degrees of pressure in the waste- heat boiler.

The analysis has been conducted for the entire range of the capacities of manufactured gas turbines $N_{el,n}^{GT} \in (0;350 \text{ MW})$ and for single-, dual- and triple-pressure heat recovery steam generators.

2 Thermodynamic analysis of cogeneration working of modernized block

The operation of a power unit under cogeneration can be characterized by a big fluctuations of steam bleed from A2, A3 extractions and intermediate pressure – low pressure (IP-LP) crossoverpipe in the steam turbine used to feed heat exchangers XC2, XC3 and XC4 (Fig. 2). These fluctuations originate from the variable demand for thermal power and its quality regulation (Figs. 3, 4). In Fig. 3 heating power for processes of producing domestic hot water, \dot{Q}_{dhw} , has not been indicated for the needs of domestic hot water preparation; this power is delivered to the customers both in a peak season and off-peak season. The flow rate of the heating steam is subjected to changes depending on the ambient temperature. For example, steam extracted from a IP-LP crossoverpipe to feed XC4 heater assumes the biggest value at the peak season for district heating and zero value at point A and to the right of it – Fig. 3b. At this point and on its left the steam from A3 extraction to feed XC3 heater keeps at a permanently high value, while at point B it is equal to zero, and the steam from A2 extraction to feeding XC2 heater at this point assumes its maximum value. The smallest flow rate of heating steam comes from A2 extraction it is used exclusively for the needs of producing domestic hot water. In the XC2 heater network water heated to the temperature of $t_h = 70^\circ\text{C}$, while in XC3 heater to the temperature of $t_h = 90^\circ\text{C}$ and in XC4 heater to the temperature of $t_h = 135^\circ\text{C}$ (Fig. 3a).

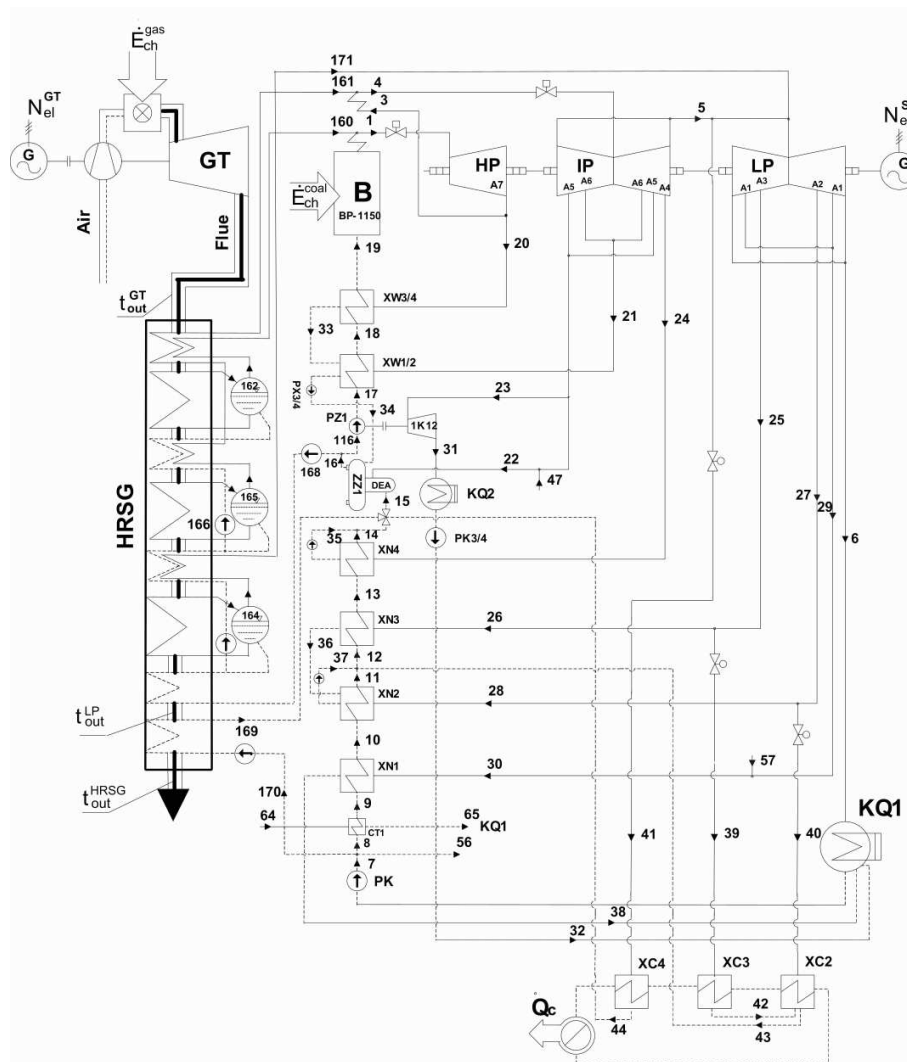

Figure 1. Thermal diagram of 370 MW electric power unit repowered by gas turbine with triple pressure heat recovery steam generator and operating under combined heat and power with steam supply to XC2, XC3, XC4 heaters: GT – gas turbine, G – generator, B – boiler, HP, IP, LP – high, intermediate and low pressure part of steam turbine, KQ – condenser, DEA – deaerator.

The peak thermal capacity of $\dot{Q}_{c\max} = \dot{Q}_{u\max} + \dot{Q}_{dhw} = 220$ MW was adopted in the calculations and the power of $\dot{Q}_{dhw} = 15$ MW for the purposes of producing domestic hot water (Fig. 4).

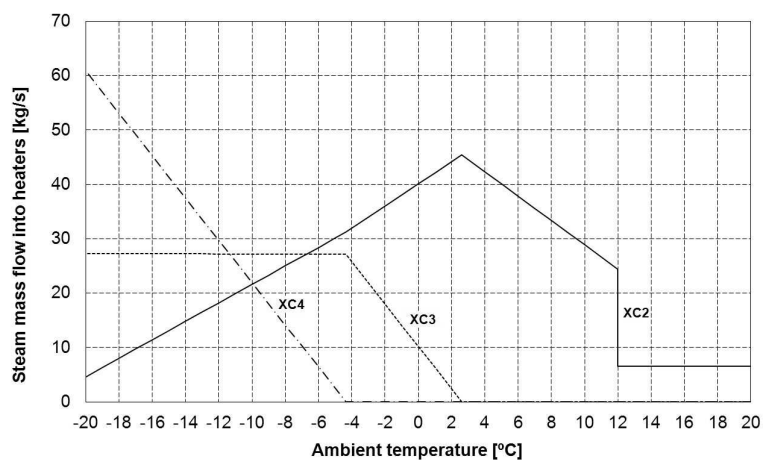

Figure 2. Heating steam mass used to feed XC2, XC3 and XC4 heaters in the function of ambient temperature.

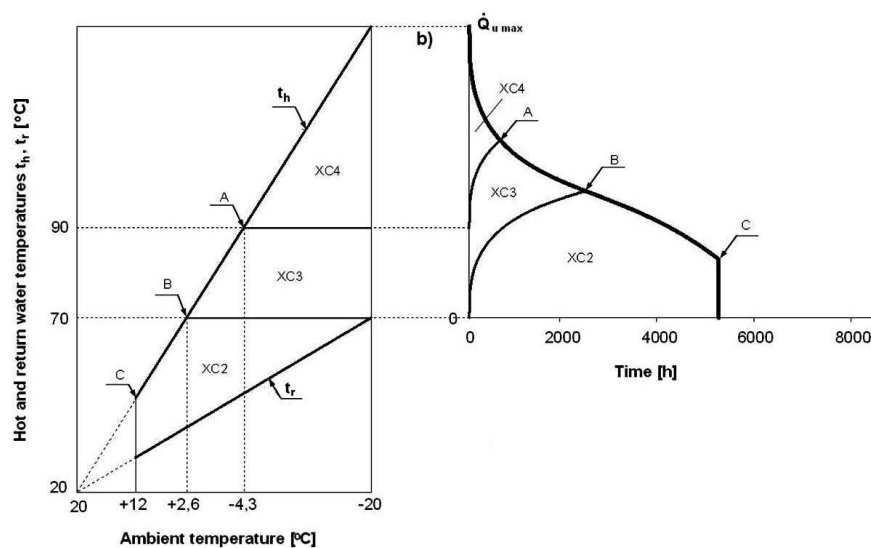

Figure 3. Qualitative regulation of thermal power output from the power station for the purposes of heating, air conditioning and ventilation of residential areas for the alternative with three heaters XC2, XC3 and XC4: a) linear regulation chart; b) annual scheduled chart of demand for thermal power (t_h , t_r – temperatures of network hot water and return water).

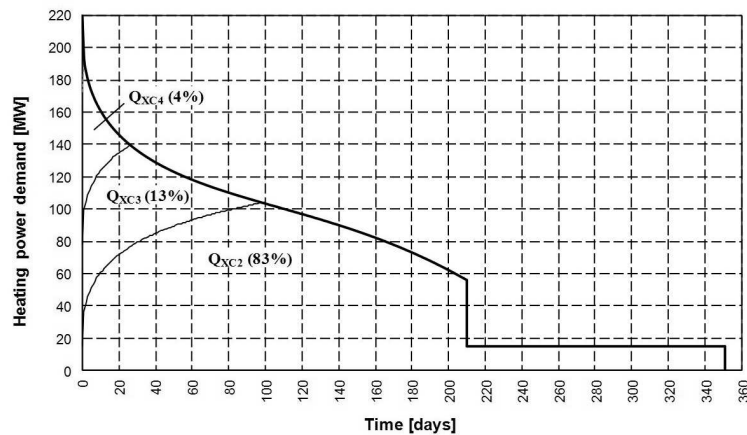
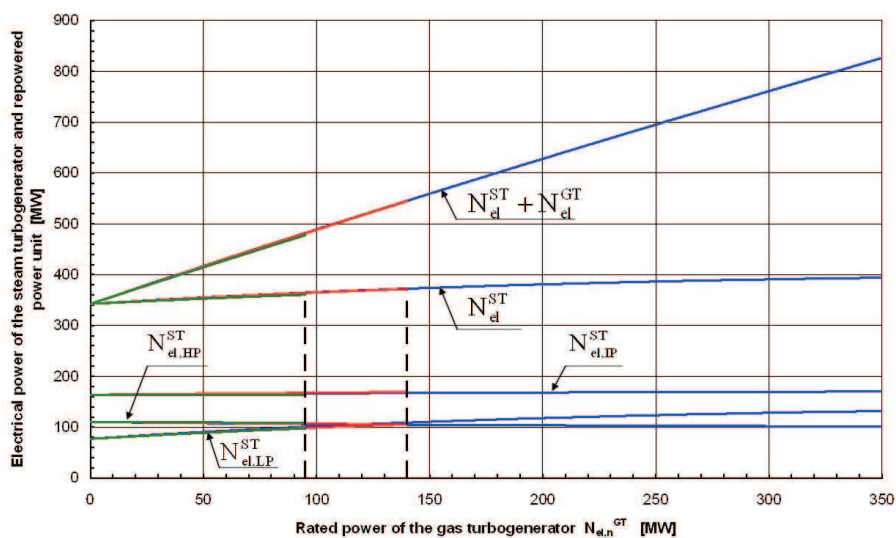

Figure 4. Annual scheduled demand for heating power.

The selected outcomes of thermodynamic calculations involving several alternatives are presented in Figs. 5–7. The results are presented for three ambient temperatures: -20°C , $+8.1^{\circ}\text{C}$ and $+20^{\circ}\text{C}$. It is purposeful as at these temperatures the power unit operates at different thermal powers so the values of particular thermodynamic parameters of its operations are different. Hence, there are different conditions resulting from them [4], which decide on the boundary capacity of the gas turbine power used to repower the existing coal-fired power unit. At the temperature of -20°C the power unit operates with the maximum heating power of 220 MW; thus, with the maximum flow rate of bleed steam into XC2, XC3 and XC4 heaters. The thermal power for an average annual temperature of $+8.1^{\circ}\text{C}$ is considerably smaller than the maximum power, and for the temperature of $+20^{\circ}\text{C}$ the power unit works with the lowest annual heating power equal to 15 MW only for the purposes of domestic hot water (Figs. 2–4).

Broken vertical lines in Figs. 5–7 used to limit the particular analytic curves come from the decay of heating steam bleed into the heaters in the section of low-pressure regeneration. Then low pressure regeneration is „taken over” by the exhaust gas-water heater situated in the rear section of the heat recovery steam generator for the range of low temperature exhaust gases. The further increase in the capacity of the gas turbine would therefore result in the decrease of energy efficiency of the modernized power unit.

Then the temperature of the flue gas from the heat recovery steam generator (HRSG) would increase above the temperature adopted for its calculations $t_{out}^{HRSG} = 90^{\circ}\text{C}$ [1,4]. The coordinate abscissa of the broken lines therefore



a)

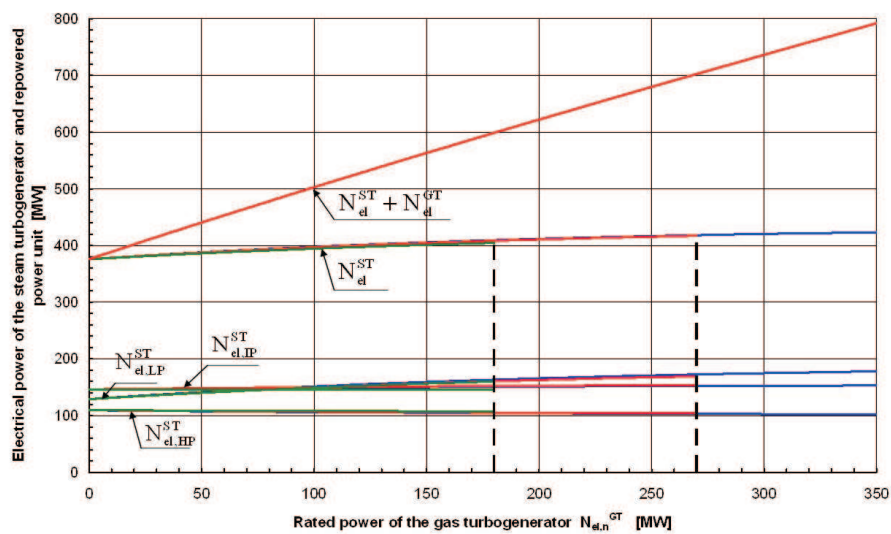

b)

Figure 5. Electrical power of the steam turbogenerator and total output of a power unit after its repowering in the function of the capacity of the gas turbogenerator and structure of the heat recovery steam generator for ambient temperature a) $t_{amb} = -20^\circ\text{C}$, b) $t_{amb} = +8.1^\circ\text{C}$.

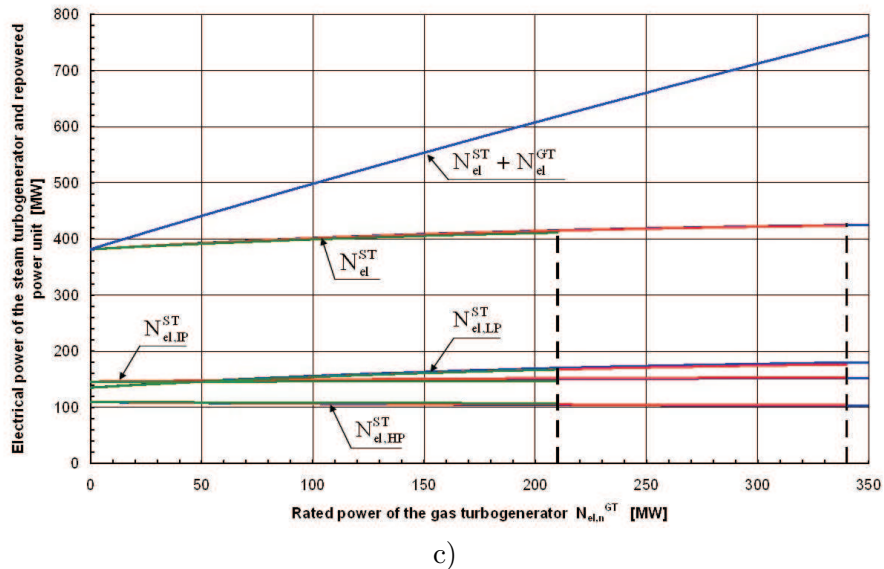
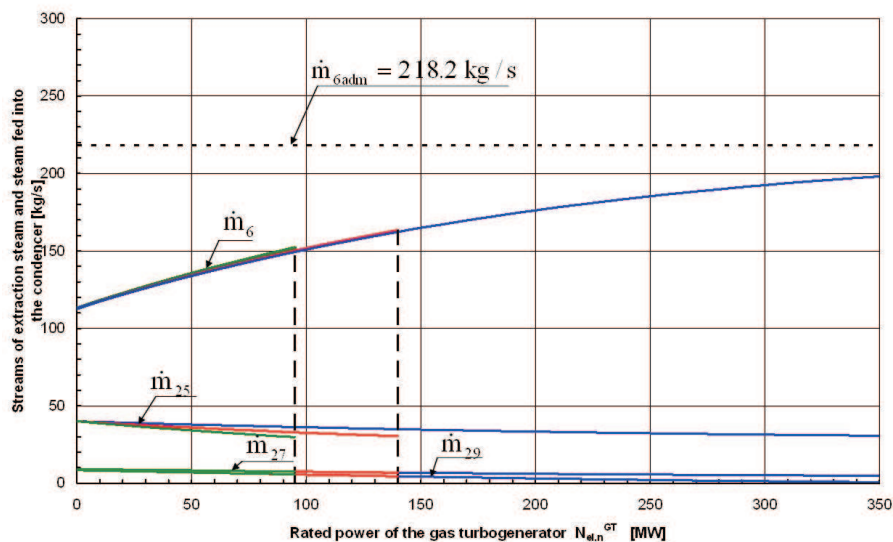
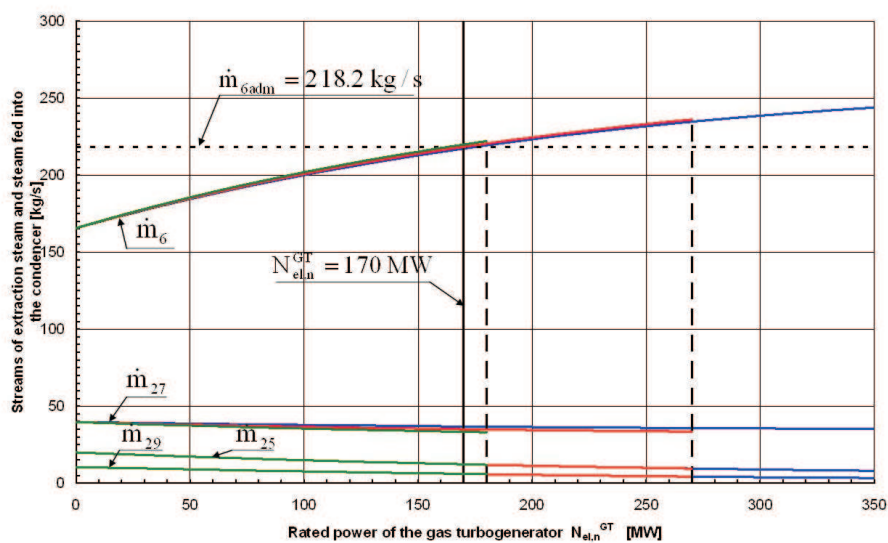

Figure 5. Electrical power of the steam turbogenerator and total output of a power unit after its repowering in the function of the capacity of the gas turbogenerator and structure of the heat recovery steam generator for ambient temperature c) $t_{amb} = +20^{\circ}\text{C}$.

represent the optimal thermodynamic capacities of gas turbines for single- and dual-pressure heat recovery steam generators. Moreover, they vary in accordance with the ambient temperature, in distinction to the condensing operation of the power unit [1]. For the ambient temperature -20°C in case of single-pressure boiler heat recovery steam generator the maximum thermodynamically justified (optimal) capacity of the gas turbogenerator is equal to $N_{el,n}^{GT} = 95$ MW, and in the case of dual-pressure boiler it is $N_{el,n}^{GT} = 140$ MW (Fig. 7a). For these capacities the entire flow rate of the condensate from condenser KQ1 is fed into the regeneration heater, for the single- and dual-pressure boilers, respectively. Thus, the further increase of the capacity of the gas turbines above 95 and 140 MW, respectively for case of single- and dual-pressure boilers, would further increase the temperature of exhaust gases from the boilers above the adopted temperature $t_{out}^{HRSG} = 90^{\circ}\text{C}$, so the energy efficiency of the repowered unit would decrease. For the temperature of $+8.1^{\circ}\text{C}$ these capacities are equal to 180 and 270 MW, respectively, as in Fig. 7b, while for the temperature of $+20^{\circ}\text{C}$, the respective values are 210 and 340 MW, Fig. 7. For the triple-pressure boiler the optimal capacity of the gas turbogenerator is over 350 MW, regardless of the ambient



a)



b)

Figure 6. Streams of extraction steam fed into low-pressure regenerative preheaters XN1, XN2, XN3 and flow rate of steam fed into the condenser in the function of the capacity of the gas turbogenerator and structure of the heat recovery steam generator for ambient temperature: a) $t_{amb} = -20^\circ\text{C}$, b) $t_{amb} = +8.1^\circ\text{C}$.

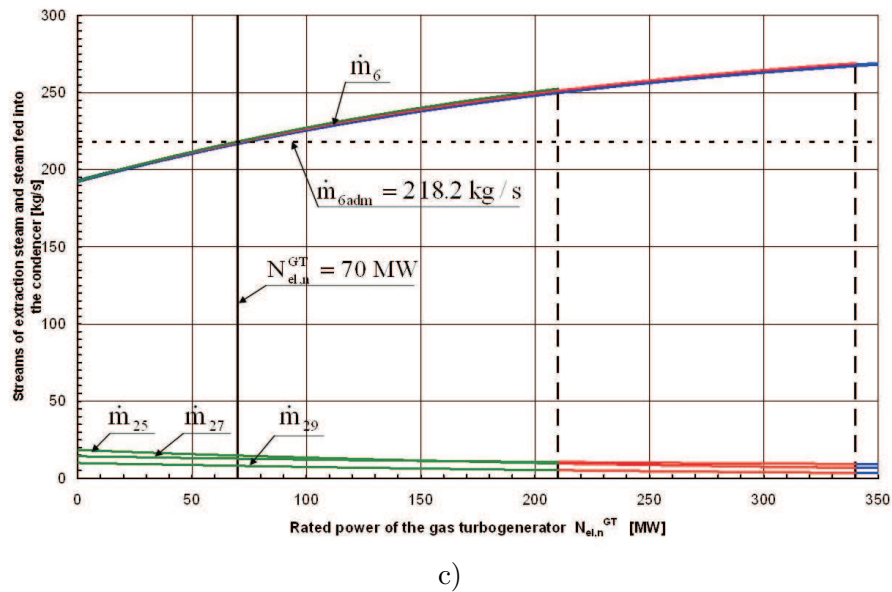
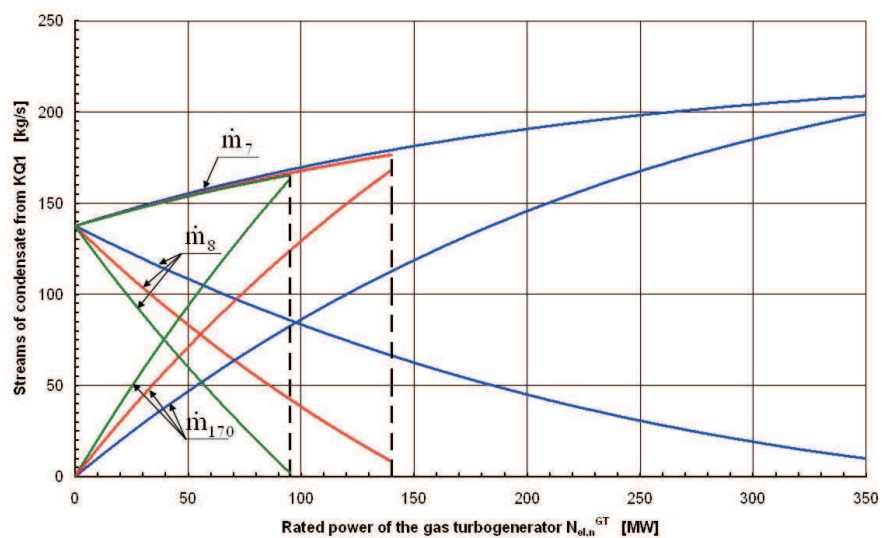

Figure 6. Streams of extraction steam fed into low-pressure regenerative preheaters XN1, XN2, XN3 and flow rate of steam fed into the condenser in the function of the capacity of the gas turbogenerator and structure of the heat recovery steam generator for ambient temperature c) $t_{amb} = +20^{\circ}\text{C}$.

temperature.

The smallest boundary value of the capacity of the gas turbogenerator is imposed by the operation under cogeneration in the off-peak season with the thermal capacity of 15 MW. This boundary value is equal to $N_{el,n}^{GT} = 70$ MW (Fig. 6c). Above this capacity, it is already necessary to install a new low-pressure section LP of the steam turbine, the condenser and the electric generator with higher capacities. If the power unit operated over the entire year with the thermal power of 220 MW, it would be unnecessary to interfere with the structure of the existing steam turbine (Figs. 5a, 6a). During operation with average annual heating power for the temperature of $+8.1^{\circ}\text{C}$, the boundary capacity of the gas turbogenerator is equal to 170 MW (Fig. 6b). Therefore, in practice the operating conditions in off-peak season with heating power for the needs of domestic hot water decides on the necessary extent of modernization of the low-pressure LP section of the power unit and the installation of a new electric generator [1]. However, the capacities of the high-pressure (HP) and intermediate pressure (IP) basically do not change, just as in the case of condensational work of power unit.



a)

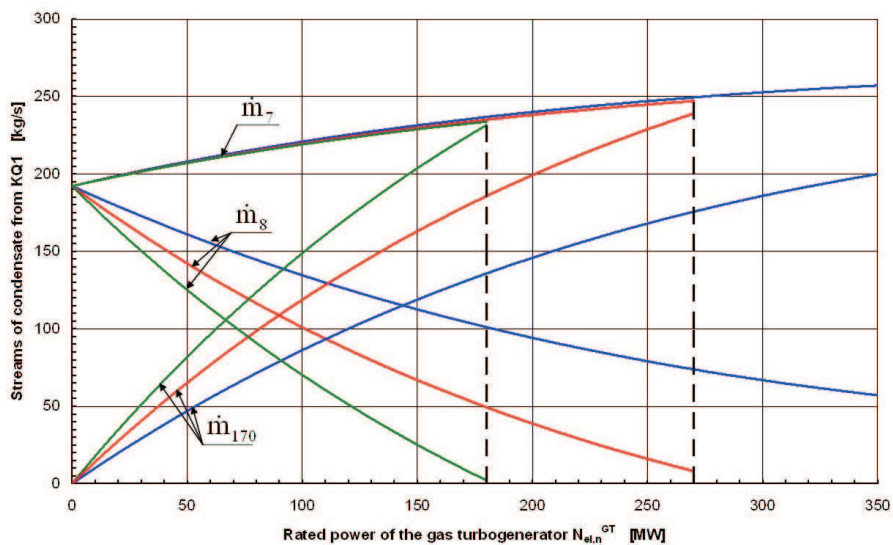

b)

Figure 7. Streams of condensate from KQ1 condenser and fed into low-pressure regenerative preheaters XN1, XN2, XN3, XN4 and regenerative preheater in the heat recovery steam generator in the function of the capacity of the gas turbogenerator and structure of the heat recovery steam generator for ambient temperature: a) $t_{amb} = -20^\circ\text{C}$, b) $t_{amb} = +8.1^\circ\text{C}$.

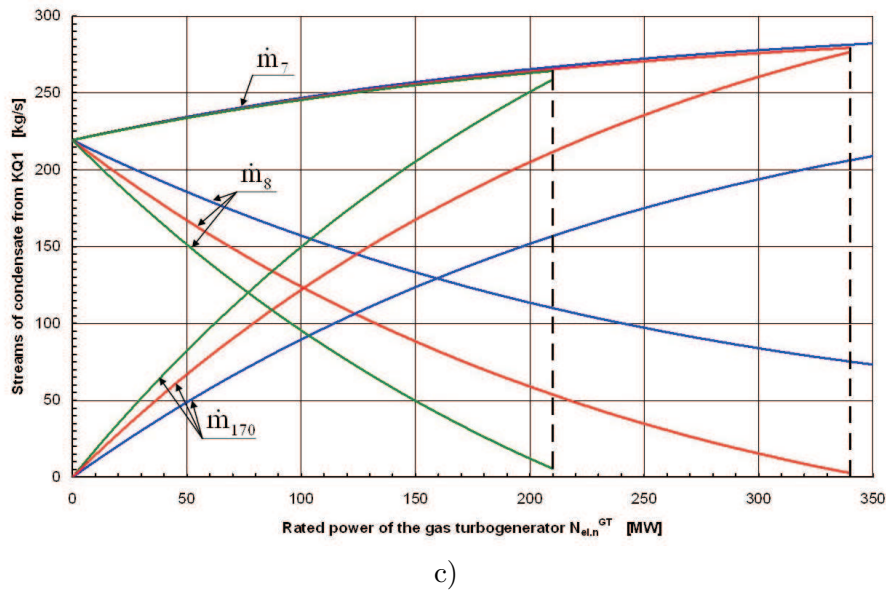

Figure 7. Streams of condensate from KQ1 condenser and fed into low-pressure regenerative preheaters XN1, XN2, XN3, XN4 and regenerative preheater in the heat recovery steam generator in the function of the capacity of the gas turbogenerator and structure of the heat recovery steam generator for ambient temperature c) $t_{amb} = +20^{\circ}\text{C}$.

The capacities of the specific facilities are presented in Fig. 5.

As it has been stated, the increase of the capacity of the steam turbogenerator after repowering the unit by the gas turbogenerator with the capacity of above $N_{el,n}^{GT} = 70$ MW is a result of the increase of the capacity of its low-pressure section caused by the greater flow of steam despite heating steam bleed into XC2, XC3, XC4 heaters. Therefore, it is necessary to design a new low-pressure section of the steam turbine, a condenser KQ1 and a new electric generator with a greater capacity.

The increased steam flow rate through the LP section of the steam turbine and the condenser and following increase of its capacity, comes a consequence of the decreased steam bleed fed into low-pressure regeneration heaters XN1, XN2, XN3, XN4 (Fig. 6) due to its partial substitution by regeneration in heat recovery steam generator and due to the smaller flow of condensate from the condenser KQ1 to them (Fig. 7). This smaller flow of condensate from the condenser into XN1–XN4 heaters results from the change in the regeneration as well as the use of steam for the needs of district heating, as discussed before. Besides, the pro-

duction of intermediate- and low-pressure steam, in case of application of dual- and triple-pressure heat recovery steam generators in system, contributes to the increase of capacity of the steam turbogenerator.

If the capacity of gas the turbine does not exceed 70 MW, steam fed into the condenser, \dot{m}_6 , (Fig. 6) does not exceed the admissible value equal to 218.2 kg/s and it is not necessary to install either new LP section of the steam turbine and the condenser KQ1. Besides, a new electric generator is not necessary. As we can conclude from the conducted calculations, the maximum tolerated steam bleed \dot{m}_6 to feed the condenser is forms the strictest limitation deciding whether on the potential need to exchange the low-pressure section of the steam turbine, condenser and electric generator.

Apart from the change of power of LP part of steam turbine and the increase of total electrical capacity of the unit, there is a considerable increase of its energy efficiency (Fig. 8). The detailed calculations of only average annual values of efficiency (and not for the particular ambient temperatures of -20°C , $+8,1^\circ\text{C}$ and $+20^\circ\text{C}$) have been undertaken exclusively for the dual-pressure heat recovery steam generator. Only such a heat recovery steam generator is economically justified [4]. Furthermore, the calculations for the range of gas turbine capacity of 220 MW have been limited because of the decreasing heating steam bleed into the low pressure regeneration XN1, XN2, XN3, XN4 heaters. The further increase of the capacity would be thermodynamically unjustified [1].

The negative value of the incremental efficiency, $\eta_{\Delta,A}$, (being the equivalent of the efficiency of generating electricity in the single-fuel gas-steam system) for the capacity of the gas turbogenerator within the range below about 8 MW is not physically contradictory, in accordance to the definition in [2,3]. The increase in the capacity of the steam turbine as a result of cogeneration is in this case negative and the absolute value is greater than the power of the gas turbogenerator.

While the power unit is being repowered by a gas turbogenerator with the capacity of 350 MW and by a triple-pressure heat recovery steam generator, the power unit's electrical capacity increases even two times and is equal to about 800 MW (Fig. 5) despite the cogeneration (heat production is then relatively small, even during the peak period, in relation to the production of electricity). Thus, the total energy efficiency of the power unit is equal to

$$\eta_{c,A} = \frac{E_{el,A}^{ST} + E_{el,A}^{GT} + Q_{c,A}}{E_{ch,A}^{coal} + E_{ch,A}^{gas}} \cong 60\%, \quad (1)$$

the incremental efficiency amounts to about $\eta_{\Delta,A} \approx 39\%$, and the apparent efficiency of the steam turbogenerator is as much as $\chi_A \approx 66\%$ [2,3]. The apparent

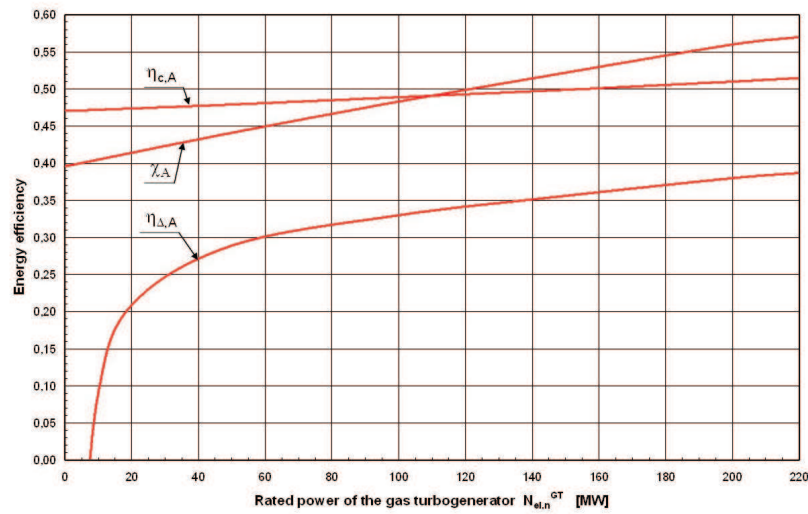

Figure 8. Mean annual energy efficiency of the repowered 370 MW unit in the function of the capacity of the gas turbogenerator coupled with dual-pressure heat recovery steam generator.

efficiency is to some extent equivalent to efficiency of electricity production in the power unit before its repowering and is equal to 41% gross.

3 Summary

For the case of the 370 MW unit repowered by gas turbogenerator and adapted to cogeneration, the boundary capacity of the gas turbogenerator is equal to 70 MW. Above this capacity the flow rate of steam fed into the condenser \dot{m}_6 exceeds the admissible value of 218.2 kg/s, regardless of the number of pressure stages in the heat recovery steam generator, Fig. 6c, so it is necessary to install low-pressure steam turbine with a greater capacity along with a condenser KQ1 and a new electric generator is required. In case of the condensing operation of the power unit, which is associated with no heating steam bleed from the steam turbine into XC2, XC3, XC4 heaters, the boundary capacity of the gas turbogenerator is 55 MW [1].

Another difference between the operation of a power unit under condensing cycle and cogeneration is the difference in the values of temperatures of the exhaust gases from single-, dual- and triple-pressure heat recovery steam generators relative to the ambient temperature. In case of a cogeneration cycle, due

to heating steam bleed into XC2, XC3, XC4 heaters, this variability is relatively big, which results from the changes of the fluxes \dot{m}_6 , \dot{m}_7 and consequently \dot{m}_{170} (Fig. 7).

Received in August 2012

References

- [1] Bartnik R., Buryn Z., Duczkowska-Kądziel A.: *The influence of structure of heat recovery steam generator and of gas turbine power repowering power unit 370 MW on its operation – condensation unit operating*. J. Energy Sci., (2012).
- [2] Bartnik R.: *Elektrownie i elektrociepłownie gazowo-parowe, efektywność energetyczna i ekonomiczna*. WNT, Warszawa 2009 (in Polish).
- [3] Bartnik R., Buryn Z.: *Conversion of Coal-Fired Power Plants to Cogeneration and Combined-Cycle*. In: Thermal and Economic Effectiveness. Springer, London 2011.
- [4] Duczkowska-Kądziel A.: *Analiza skojarzonej pracy bloku 370 MW nadbudowanego turbiną gazową*. PhD thesis. Opole University of Technology 2011 (in Polish).
- [5] PGE the Opole Power Plant – own information.

Wpływ struktury kotła odzyskowego i mocy turbozespołu gazowego nadbudowujących blok 370 MW na jego pracę – praca skojarzona bloku

S t r e s z c z e n i e

W artykule zaprezentowano rezultaty termodynamicznych obliczeń doboru struktury kotła odzyskowego i mocy turbozespołu gazowego do bloku o mocy 370 MW zmodernizowanego do dwupaliwowego układu gazowo-parowego. Obliczenia przeprowadzono dla pracy skojarzonej bloku.